

PERSPECTIVA:
(sem escala)

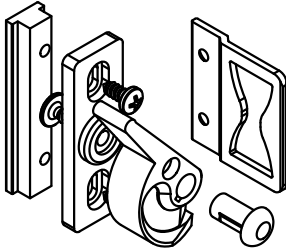

DIMENSÕES:
(escala 1:2)

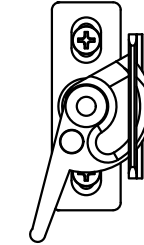

DIREITO

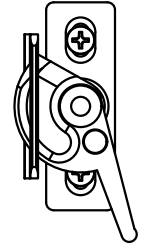

ESQUERDO

CONTRAFECHO (escala 1:2)

Acabamento: Anodizado Preto

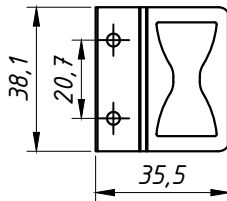

DETALHE DE APLICAÇÃO:
(Sem Escala)

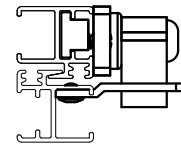

CARACTERÍSTICAS:

Componentes:	Matéria-prima:
Base	Poliamida
Trinco	Poliamida
Contrafecho	Alumínio
Acabamentos	Poliamida
Parafusos	Inox
Rebites	Alumínio

Acabamento

Preto

Embalagem	10 Fechos
	20 Parafusos
	10 Contrafechos
	20 Rebites

USINAGEM

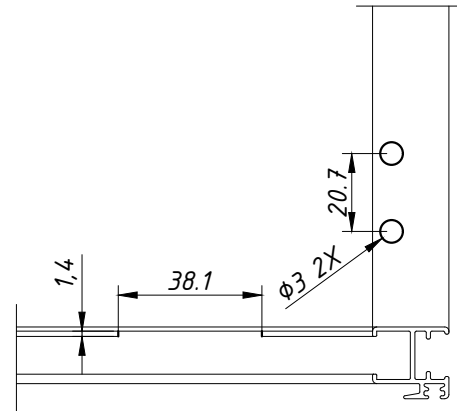

CÓDIGO	ACABAMENTO
FEC-1126D	Direito/Preto
FEC-1126E	Esquerdo/Preto

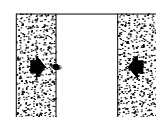

JANELAS
DE CORRER
2 FOLHAS