



FECHO CONCHA COM CHAVE AUTOMÁTICO E MANUAL

APLICAÇÃO:
- LINHAS:
DIVERSAS

Fevereiro/2009

PERSPECTIVA:
(sem escala)

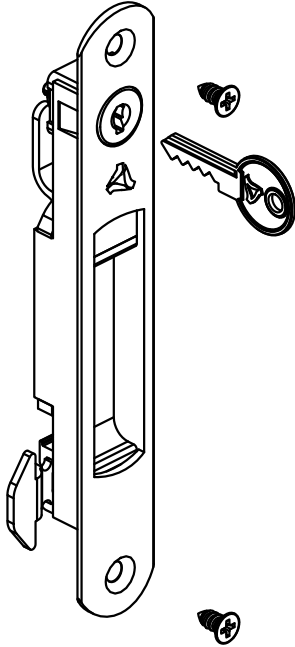

DIMENSÕES:
(escala 1:2)

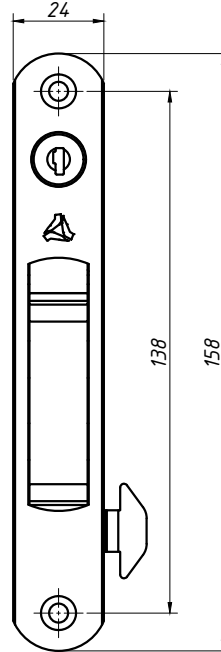
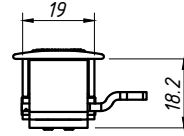
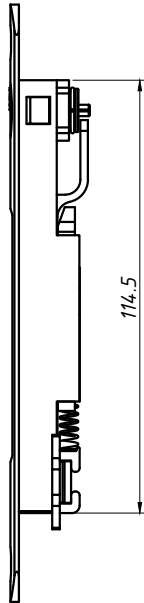

USINAGEM:
(escala 1:2)

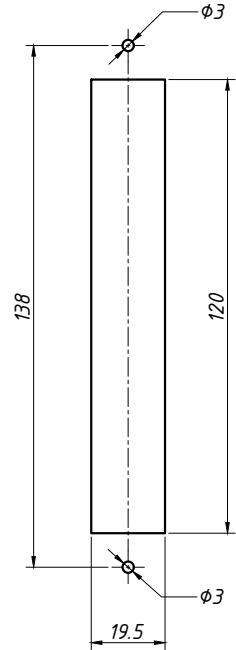

CÓDIGO:	APLICAÇÃO TRAVA / LINHAS
LIN-03	Inova®, Master® e Smart 2.0®
LIN-04	25®, 30®, Suprema®, Gold®, Mega 32, Alumiconte Mega® Linha 32, D'oro® MP®, Hydro Oficial®, Madeira, SP20® e Absoluta®

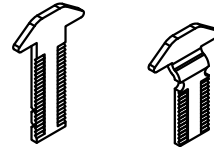

ATENÇÃO:

VERIFICAR QUAL O TIPO DE TRAVA IDEAL PARA O PROJETO

CÓD: LIN-04 CÓD: LIN-03

CARACTERÍSTICAS:

Componentes:	Matéria-prima:
Estrutura	Alumínio
Lingueta	Aço Inox
Parafusos	Aço Inox
Limitador	Poliamida
Acabamentos	Poliamida
Chave	Latão
Cilindro	Zamac

DETALHE DE APLICAÇÃO: (sem escala)

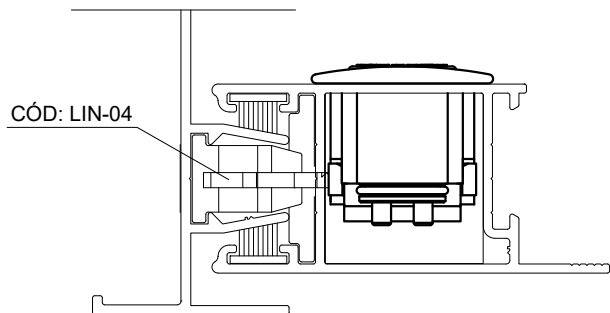

Acabamento		
Preto	Fosco	Branco

CÓDIGO	ACABAMENTO
FEC-1035 (Manual)	Preto
FEC-10350 (Manual)	Fosco
FEC-1035EB (Manual)	Branco
FEC-1036 (Autom.)	Preto
FEC-10360 (Autom.)	Fosco
FEC-1036EB (Autom.)	Branco

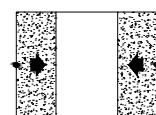

JANELAS
E PORTAS
DE CORRER