





**ALUMICONTE**

COMPONENTES • PERFIS • PERSIANAS



ALUMICONTE

TEL. +55 (54)3447-4000

RUA CONDE DE PORTO ALEGRE, 1000 - CENTRO

CEP 95334-000 - VILA FLORES/RS - WWW.ALUMICONTE.COM.BR

4ª EDIÇÃO • 2022 • REVISÃO 08

Você encontra a versão atualizada deste catálogo em nosso site,  
[www.alumiconte.com.br](http://www.alumiconte.com.br)

# GRANDE COMO AS MINHAS IDEIAS

São  
mais de:

**30 anos**  
de experiência no setor

**4.500**  
itens

**18.000m<sup>2</sup>**  
de área fabril

## RESPEITO AO MEIO AMBIENTE

Nos preocupamos com o meio ambiente e, entre nossos princípios básicos, está o gerenciamento ambiental.

A empresa propõe-se, como um dos principais requisitos, o atendimento às diretrizes e os compromissos ambientais gerados nas esferas municipal, estadual e federal. Neste aspecto, implantou em 1999 uma estação de tratamento de efluentes líquidos industriais com área construída de 600m<sup>2</sup>, além de:

1. Priorizar a redução na geração de resíduos.
2. Implantar técnicas de tratamento e disposição com baixo consumo de energia e espaço físico.
3. Sempre que possível optar pelo reúso e/ou pela reciclagem.
4. Operar o processo produtivo maximizando as tecnologias limpas.
5. Gerenciar os resíduos, preservando assim, a qualidade ambiental e socioeconômica da comunidade na qual estamos inseridos.

## COMPROMISSO TOTAL COM A QUALIDADE

São premissas básicas da **Alumiconte**: atuar na melhoria contínua de nossos produtos e processos, seguindo normas nacionais e internacionais (ABNT - Associação Brasileira de Normas Técnicas, ISO 9001:2015 e ISO 14001:2015) sempre que aplicáveis, visando o atendimento das necessidades e expectativas dos nossos clientes e partes interessadas, além de estimular, motivar e capacitar os colaboradores a participarem e se comprometerem com os **Programas de Qualidade** em todos os níveis do processo, garantindo assim, produtos com alto padrão de qualidade e a satisfação dos clientes.



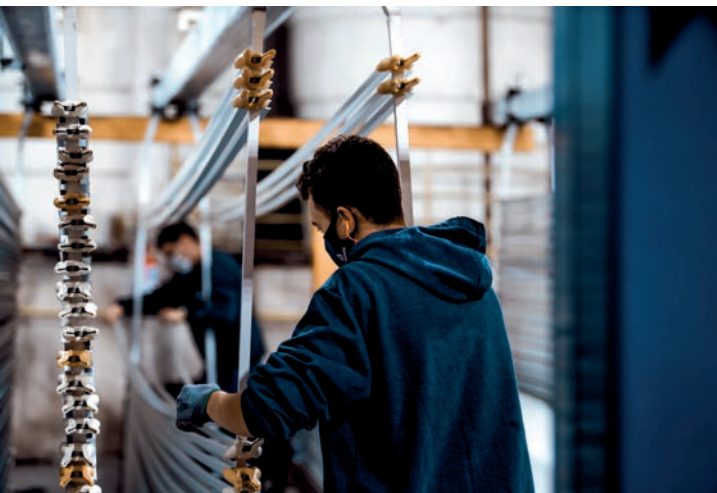

saiba mais sobre

## EXTRUSÃO DE ALUMÍNIO

A extrusão é um processo de produção de componentes mecânicos de forma semicontínua, no qual o alumínio é forçado através de uma matriz, adquirindo assim a forma predeterminada de acordo com a necessidade. Perfis de alumínio são utilizados nos ramos de construção civil, indústria naval, aeroespacial, automobilística e moveleira.

Na **Alumiconte**, contamos com 3 grandes extrusoras de alumínio, com capacidade produtiva mensal de mais de 500.000kg, voltados a atender a construção civil, setor moveleiro e industrial.

### CONSTRUÇÃO CIVIL

Perfis voltados para a produção de esquadrias, oferecemos ampla gama de produtos, atendendo de forma eficiente às necessidades do serralheiro, entregando alto padrão estético, de qualidade e funcionalidade.

### INDÚSTRIA MOVELEIRA

Em nosso portfólio de itens voltados para indústria moveleira, você encontra mais de 600 produtos em linha, que atendem a inúmeras formas e aplicações.

### PERFIS PERSONALIZADOS

Dispomos de setor de engenharia focado na busca pela solução ideal para cada projeto, produzindo Perfis personalizados, de acordo com o design e necessidade do cliente.

## ANODIZAÇÃO

Anodização é o processo de criar uma camada de óxido sobre a superfície do alumínio por meio da imersão em um banho eletrolítico, no qual o metal a anodizar é ligado ao polo positivo de uma fonte de eletricidade. Isso evita a oxidação natural do alumínio mantendo seu aspecto de novo durante muitos anos.

Contamos com mais de duas décadas de experiência na anodização de produtos, o que contribui para a alta qualidade constante.

## PINTURA ELETROSTÁTICA

A pintura eletrostática a pó é um processo de pintura que tem como finalidade o revestimento do alumínio com uma película de polímero termo-endurecível, aplicado na superfície através de atração eletrostática e submetido a um processo de cura em alta temperatura por um determinado tempo.

## PERFIL PUXADOR DE ENCAIXE

18 mm

CÓDIGO	P.	CÓDIGO	P.	CÓDIGO	P.	CÓDIGO	P.	CÓDIGO	P.
DES-009	10	DES-192	19	DES-314	17	DES-885	20	DES-1273	20
DES-022	18	DES-197	13	DES-337	18	DES-923	15	DES-1400	12
DES-074	10	DES-201	13	DES-385	12	DES-931	13	DES-1404	16
DES-089	11	DES-202	11	DES-404	15	DES-949	13	DES-1432	16
DES-094	19	DES-212	11	DES-611	18	DES-960	10	DES-1465	21
DES-102	12	DES-224	15	DES-620	12	DES-999	14	DES-1696	20
DES-108	17	DES-264	10	DES-622	19	DES-1063	14		
DES-132	17	DES-266	18	DES-623	20	DES-1068	14		
DES-142	17	DES-275	11	DES-878	16	DES-1069	14		
DES-173	15	DES-305	16	DES-883	21	DES-1272	19		

## PERFIL PUXADOR DE ENCAIXE

15 mm

CÓDIGO	P.	CÓDIGO	P.	CÓDIGO	P.	CÓDIGO	P.	CÓDIGO	P.
DES-162	25	DES-222	26	DES-284	24	DES-933	28	DES-1078	25
DES-194	26	DES-234	26	DES-312	25	DES-970	24	DES-1322	27
DES-213	23	DES-238	27	DES-339	23	DES-1011	26	DES-1401	25
DES-214	23	DES-265	27	DES-345	27	DES-1062	24	DES-1405	28
DES-221	28	DES-270	23	DES-621	24	DES-1077	25	DES-1431	28

## PERFIL PUXADOR

CÓDIGO	P.	CÓDIGO	P.	CÓDIGO	P.	CÓDIGO	P.	CÓDIGO	P.
DES-043	29	DES-149	35	DES-680	39	DES-909	34	DES-1324	36
DES-046	37	DES-175	39	DES-695	32	DES-976	40	DES-1329	34
DES-063	37	DES-203	34	DES-826	39	DES-993	35	DES-1332	34
DES-064	37	DES-232	40	DES-833	32	DES-1013	36	DES-1420	30
DES-088	38	DES-239	29	DES-842	32	DES-1251	31	DES-1421	30
DES-090	38	DES-296	33	DES-872	39	DES-1252	31	DES-1423	38
DES-112	31	DES-347	37	DES-879	40	DES-1278	35	DES-1613	29
DES-144	32	DES-353	40	DES-881	38	DES-1280	31	DES-1614	30
DES-145	33	DES-395	33	DES-901	36	DES-1299	36	DES-1615	30
DES-148	35	DES-519	29	DES-908	33	DES-1319	34		

## PERFIL QUADRO DE VIDRO

CÓDIGO	P.	CÓDIGO	P.	CÓDIGO	P.	CÓDIGO	P.	CÓDIGO	P.
DES-001	42	DES-073	52	DES-300	51	DES-953	54	DES-1326	48
DES-002	42	DES-084	44	DES-311	45	DES-1042	57	DES-1328	49
DES-007	42	DES-128	53	DES-318	45	DES-1060	47	DES-1402	48
DES-008	42	DES-129	50	DES-523	45	DES-1073	54	DES-1407	56
DES-010	43	DES-130	50	DES-530	46	DES-1093	57	DES-1414	55
DES-014	43	DES-131	53	DES-550	46	DES-1226	56	DES-1451	55
DES-015	52	DES-133	44	DES-691	46	DES-1250	57	DES-1452	48
DES-016	50	DES-147	53	DES-832	43	DES-1264	48	DES-1490	49
DES-017	52	DES-178	51	DES-875	46	DES-1279	54	DES-1492	56
DES-018	52	DES-198	44	DES-902	47	DES-1291	51	DES-1609	49
DES-019	51	DES-226	53	DES-912	57	DES-1300	55	DES-1612	49
DES-060	50	DES-233	44	DES-929	47	DES-1301	55		
DES-062	43	DES-297	45	DES-951	54	DES-1321	56		

## PERFIL QUADRO DE VIDRO COM PUXADOR

CÓDIGO	P.	CÓDIGO	P.	CÓDIGO	P.	CÓDIGO	P.	CÓDIGO	P.
DES-011	64	DES-227	67	DES-692	62	DES-1061	59	DES-1408	68
DES-012	63	DES-279	65	DES-730	58	DES-1074	68	DES-1419	61
DES-026	64	DES-282	59	DES-877	62	DES-1094	66	DES-1489	62
DES-076	61	DES-301	66	DES-897	63	DES-1225	67	DES-1491	68
DES-078	65	DES-313	62	DES-930	60	DES-1227	67	DES-1610	61
DES-158	61	DES-320	63	DES-940	63	DES-1228	68	DES-1697	68
DES-187	65	DES-362	66	DES-950	60	DES-1265	64		
DES-193	65	DES-370	58	DES-1012	64	DES-1268	60		
DES-204	58	DES-551	58	DES-1014	60	DES-1271	68		
DES-225	67	DES-690	59	DES-1043	66	DES-1403	59		

## TRAVESSA QUADRO DE VIDRO

CÓDIGO	P.	CÓDIGO	P.	CÓDIGO	P.	CÓDIGO	P.
DES-077	70	DES-856	71	DES-1016	71	DES-1075	70
DES-168	69	DES-868	71	DES-1017	70	DES-1297	70
DES-247	69	DES-952	69	DES-1044	71	DES-1453	69

## PERFIL TRILHO DE CORRER

## SUPERIOR

CÓDIGO	P.	CÓDIGO	P.	CÓDIGO	P.	CÓDIGO	P.	CÓDIGO	P.
DES-032	79	DES-156	79	DES-287	80	DES-593	76	DES-944	77
DES-035	77	DES-167	75	DES-340	80	DES-594	76	DES-980	78
DES-036	74	DES-169	80	DES-379	80	DES-595	76	DES-992	78
DES-037	74	DES-200	74	DES-380	77	DES-601	82	DES-1274	83
DES-038	78	DES-261	75	DES-390	79	DES-813	82	DES-1433	77
DES-039	75	DES-262	75	DES-480	81	DES-844	82	DES-1434	81
DES-044	74	DES-269	79	DES-511	81	DES-886	76	DES-1698	77
DES-050A	80	DES-273	78	DES-524	81	DES-906	82		

## PERFIL TRILHO DE CORRER

## INFERIOR

CÓDIGO	P.	CÓDIGO	P.	CÓDIGO	P.	CÓDIGO	P.	CÓDIGO	P.
DES-041	84	DES-058	88	DES-294	85	DES-603	87	DES-907	88
DES-042	85	DES-113	85	DES-309	86	DES-820	86	DES-1275	88
DES-049	88	DES-155	84	DES-315	84	DES-824	88	DES-1284	86
DES-051	87	DES-188	86	DES-344	87	DES-836	88		
DES-055	84	DES-228	87	DES-512	85	DES-843	88		

## PERFIL TESTEIRA

CÓDIGO	P.	CÓDIGO	P.	CÓDIGO	P.	CÓDIGO	P.	CÓDIGO	P.
DES-143	90	DES-205	92	DES-248	90	DES-293	92	DES-884	92
DES-150	92	DES-240	92	DES-249	91	DES-693	90	DES-1620	91
DES-165	91	DES-241	92	DES-292	90	DES-694	91		

## PERFIL MONTANTE PUXADOR

CÓDIGO	P.	CÓDIGO	P.	CÓDIGO	P.	CÓDIGO	P.	CÓDIGO	P.
DES-104	93	DES-258	96	DES-291	94	DES-810	95	DES-846	96
DES-121	94	DES-259	94	DES-307	93	DES-812	96	DES-874	96
DES-127	93	DES-260	96	DES-334	94	DES-819	95		
DES-257	96	DES-290	93	DES-675	95	DES-822	95		

## PERFIL PARA DIVISÓRIAS

CÓDIGO	P.	CÓDIGO	P.	CÓDIGO	P.	CÓDIGO	P.	CÓDIGO	P.
DES-302	97	DES-596	97	DES-599	97	DES-1293	98	DES-1483	99
DES-303	97	DES-597	98	DES-600	98	DES-1481	99		
DES-304	97	DES-598	99	DES-799	98	DES-1482	99		

## PERFIL VITRINE

CÓDIGO	P.	CÓDIGO	P.	CÓDIGO	P.	CÓDIGO	P.	CÓDIGO	P.
DES-075	100	DES-400	101	DES-674	103	DES-932	101	DES-1412	102
DES-335	100	DES-671	103	DES-740	103	DES-987	101	DES-1413	102
DES-336	100	DES-672	103	DES-741	103	DES-988	102	DES-1445	102
DES-366	100	DES-673	103	DES-894	101	DES-1289	102		

## PERFIS DIVERSOS

CÓDIGO	P.	CÓDIGO	P.	CÓDIGO	P.	CÓDIGO	P.	CÓDIGO	P.
ALU-043	121	DES-100	106	DES-602	119	DES-1254	131	DES-1458	122
ALU-044	122	DES-140	115	DES-615	124	DES-1255	131	DES-1477	127
BXT-482	117	DES-151	121	DES-616	124	DES-1270	126	DES-1478	127
BXT-483	117	DES-157	105	DES-666	124	DES-1276	108	DES-1479	127
BXT-484	117	DES-161	105	DES-670	125	DES-1277	107	DES-1480	128
BXT-485	118	DES-163	106	DES-677	120	DES-1281	126	DES-1487	128
BXT-496	120	DES-171	123	DES-678	120	DES-1290	126	DES-1488	128
BXT-497	112	DES-181	107	DES-742	116	DES-1294	113	DES-1510	114
BXT-498	122	DES-229	123	DES-841	125	DES-1295	113	DES-1511	106
BXT-499	112	DES-243	121	DES-851	108	DES-1298	110	DES-1512	114
BXT-500	112	DES-244	121	DES-852	108	DES-1302	114	DES-1513	114
DES-027D6	122	DES-246	124	DES-873	116	DES-1303	110	DES-1514	115
DES-052	105	DES-255	118	DES-880	131	DES-1304	110	DES-1515	129
DES-079	108	DES-256	118	DES-888	125	DES-1407	126	DES-1516	129
DES-083	123	DES-267	116	DES-998	119	DES-1409	128	DES-1517	130
DES-086	115	DES-271	106	DES-1009	117	DES-1410	129	DES-1518	130
DES-087	115	DES-289	111	DES-1026	119	DES-1411	129	DES-1519	130
DES-093	123	DES-319	116	DES-1040	119	DES-1443	110	DES-1721	113
DES-097	111	DES-342	111	DES-1083	125	DES-1444	111	DES-1722	113
DES-098	107	DES-386	118	DES-1104	120	DES-1455	112		
DES-099	107	DES-387	105	DES-1253	130	DES-1457	127		

## PERFIL ESQUADRIA DE MADEIRA

CÓDIGO	P.	CÓDIGO	P.	CÓDIGO	P.	CÓDIGO	P.	CÓDIGO	P.
DES-006	133	DES-029	135	DES-034	134	DES-164	134	DES-876	135
DES-027	133	DES-031	135	DES-040	135	DES-166	135		
DES-028	133	DES-033	134	DES-059	133	DES-242	134		

<b>CÓDIGO</b>	<b>P.</b>	<b>CÓDIGO</b>	<b>P.</b>	<b>CÓDIGO</b>	<b>P.</b>	<b>CÓDIGO</b>	<b>P.</b>	<b>CÓDIGO</b>	<b>P.</b>
ALU-043	121	DES-052	105	DES-151	121	DES-242	134	DES-319	116
ALU-044	122	DES-055	84	DES-155	84	DES-243	121	DES-320	63
BXT-482	117	DES-058	88	DES-156	79	DES-244	121	DES-334	94
BXT-483	117	DES-059	133	DES-157	105	DES-246	124	DES-335	100
BXT-484	117	DES-060	50	DES-158	61	DES-247	69	DES-336	100
BXT-485	118	DES-062	43	DES-161	105	DES-248	90	DES-337	18
BXT-496	120	DES-063	37	DES-162	25	DES-249	91	DES-339	23
BXT-497	112	DES-064	37	DES-163	106	DES-255	118	DES-340	80
BXT-498	122	DES-073	52	DES-164	134	DES-256	118	DES-342	111
BXT-499	112	DES-074	10	DES-165	91	DES-257	96	DES-344	87
BXT-500	112	DES-075	100	DES-166	135	DES-258	96	DES-345	27
DES-001	42	DES-076	61	DES-167	75	DES-259	94	DES-347	37
DES-002	42	DES-077	70	DES-168	69	DES-260	96	DES-353	40
DES-006	133	DES-078	65	DES-169	80	DES-261	75	DES-362	66
DES-007	42	DES-079	108	DES-171	123	DES-262	75	DES-366	100
DES-008	42	DES-083	123	DES-173	15	DES-264	10	DES-370	58
DES-009	10	DES-084	44	DES-175	39	DES-265	27	DES-379	80
DES-010	43	DES-086	115	DES-178	51	DES-266	18	DES-380	77
DES-011	64	DES-087	115	DES-181	107	DES-267	116	DES-385	12
DES-012	63	DES-088	38	DES-187	65	DES-269	79	DES-386	118
DES-014	43	DES-089	11	DES-188	86	DES-270	23	DES-387	105
DES-015	52	DES-090	38	DES-192	19	DES-271	106	DES-390	79
DES-016	50	DES-093	123	DES-193	65	DES-273	78	DES-395	33
DES-017	52	DES-094	19	DES-194	26	DES-275	11	DES-400	101
DES-018	52	DES-097	111	DES-197	13	DES-279	65	DES-404	15
DES-019	51	DES-098	107	DES-198	44	DES-282	59	DES-480	81
DES-022	18	DES-099	107	DES-200	74	DES-284	24	DES-511	81
DES-026	64	DES-100	106	DES-201	13	DES-287	80	DES-512	85
DES-027	133	DES-102	12	DES-202	11	DES-289	111	DES-519	29
DES-027D6	122	DES-104	93	DES-203	34	DES-290	93	DES-523	45
DES-028	133	DES-108	17	DES-204	58	DES-291	94	DES-524	81
DES-029	135	DES-112	31	DES-205	92	DES-292	90	DES-530	46
DES-031	135	DES-113	85	DES-212	11	DES-293	92	DES-550	46
DES-032	79	DES-121	94	DES-213	23	DES-294	85	DES-551	58
DES-033	134	DES-127	93	DES-214	23	DES-296	33	DES-593	76
DES-034	134	DES-128	53	DES-221	28	DES-297	45	DES-594	76
DES-035	77	DES-129	50	DES-222	26	DES-300	51	DES-595	76
DES-036	74	DES-130	50	DES-224	15	DES-301	66	DES-596	97
DES-037	74	DES-131	53	DES-225	67	DES-302	97	DES-597	98
DES-038	78	DES-132	17	DES-226	53	DES-303	97	DES-598	99
DES-039	75	DES-133	44	DES-227	67	DES-304	97	DES-599	97
DES-040	135	DES-140	115	DES-228	87	DES-305	16	DES-600	98
DES-041	84	DES-142	17	DES-229	123	DES-307	93	DES-601	82
DES-042	85	DES-143	90	DES-232	40	DES-309	86	DES-602	119
DES-043	29	DES-144	32	DES-233	44	DES-311	45	DES-603	87
DES-044	74	DES-145	33	DES-234	26	DES-312	25	DES-611	18
DES-046	37	DES-147	53	DES-238	27	DES-313	62	DES-615	124
DES-049	88	DES-148	35	DES-239	29	DES-314	17	DES-616	124
DES-050A	80	DES-149	35	DES-240	92	DES-315	84	DES-620	12
DES-051	87	DES-150	92	DES-241	92	DES-318	45	DES-621	24



<b>CÓDIGO</b>	<b>P.</b>	<b>CÓDIGO</b>	<b>P.</b>	<b>CÓDIGO</b>	<b>P.</b>	<b>CÓDIGO</b>	<b>P.</b>	<b>CÓDIGO</b>	<b>P.</b>
DES-622	19	DES-879	40	DES-1043	66	DES-1298	110	DES-1479	127
DES-623	20	DES-880	131	DES-1044	71	DES-1299	36	DES-1480	128
DES-666	124	DES-881	38	DES-1060	47	DES-1300	55	DES-1481	99
DES-670	125	DES-883	21	DES-1061	59	DES-1301	55	DES-1482	99
DES-671	103	DES-884	92	DES-1062	24	DES-1302	114	DES-1483	99
DES-672	103	DES-885	20	DES-1063	14	DES-1303	110	DES-1487	128
DES-673	103	DES-886	76	DES-1068	14	DES-1304	110	DES-1488	128
DES-674	103	DES-888	125	DES-1069	14	DES-1319	34	DES-1489	62
DES-675	95	DES-894	101	DES-1073	54	DES-1321	56	DES-1490	49
DES-677	120	DES-897	63	DES-1074	68	DES-1322	27	DES-1491	68
DES-678	120	DES-901	36	DES-1075	70	DES-1324	36	DES-1492	56
DES-680	39	DES-902	47	DES-1077	25	DES-1326	48	DES-1510	114
DES-690	59	DES-906	82	DES-1078	25	DES-1328	49	DES-1511	106
DES-691	46	DES-907	88	DES-1083	125	DES-1329	34	DES-1512	114
DES-692	62	DES-908	33	DES-1093	57	DES-1332	34	DES-1513	114
DES-693	90	DES-909	34	DES-1094	66	DES-1400	12	DES-1514	115
DES-694	91	DES-912	57	DES-1104	120	DES-1401	25	DES-1515	129
DES-695	32	DES-923	15	DES-1225	67	DES-1402	48	DES-1516	129
DES-730	58	DES-929	47	DES-1226	56	DES-1403	59	DES-1517	130
DES-740	103	DES-930	60	DES-1227	67	DES-1404	16	DES-1518	130
DES-741	103	DES-931	13	DES-1228	68	DES-1405	28	DES-1519	130
DES-742	116	DES-932	101	DES-1250	57	DES-1407	126	DES-1609	49
DES-799	98	DES-933	28	DES-1251	31	DES-1407	56	DES-1610	61
DES-810	95	DES-940	63	DES-1252	31	DES-1408	68	DES-1612	49
DES-812	96	DES-944	77	DES-1253	130	DES-1409	128	DES-1613	29
DES-813	82	DES-949	13	DES-1254	131	DES-1410	129	DES-1614	30
DES-819	95	DES-950	60	DES-1255	131	DES-1411	129	DES-1615	30
DES-820	86	DES-951	54	DES-1264	48	DES-1412	102	DES-1620	91
DES-822	95	DES-952	69	DES-1265	64	DES-1413	102	DES-1696	20
DES-824	88	DES-953	54	DES-1268	60	DES-1414	55	DES-1697	68
DES-826	39	DES-960	10	DES-1270	126	DES-1419	61	DES-1698	77
DES-832	43	DES-970	24	DES-1271	68	DES-1420	30	DES-1721	113
DES-833	32	DES-976	40	DES-1272	19	DES-1421	30	DES-1722	113
DES-836	88	DES-980	78	DES-1273	20	DES-1423	38		
DES-841	125	DES-987	101	DES-1274	83	DES-1431	28		
DES-842	32	DES-988	102	DES-1275	88	DES-1432	16		
DES-843	88	DES-992	78	DES-1276	108	DES-1433	77		
DES-844	82	DES-993	35	DES-1277	107	DES-1434	81		
DES-846	96	DES-998	119	DES-1278	35	DES-1443	110		
DES-851	108	DES-999	14	DES-1279	54	DES-1444	111		
DES-852	108	DES-1009	117	DES-1280	31	DES-1445	102		
DES-856	71	DES-1011	26	DES-1281	126	DES-1451	55		
DES-868	71	DES-1012	64	DES-1284	86	DES-1452	48		
DES-872	39	DES-1013	36	DES-1289	102	DES-1453	69		
DES-873	116	DES-1014	60	DES-1290	126	DES-1455	112		
DES-874	96	DES-1016	71	DES-1291	51	DES-1457	127		
DES-875	46	DES-1017	70	DES-1293	98	DES-1458	122		
DES-876	135	DES-1026	119	DES-1294	113	DES-1465	21		
DES-877	62	DES-1040	119	DES-1295	113	DES-1477	127		
DES-878	16	DES-1042	57	DES-1297	70	DES-1478	127		

# PERFIL PUXADOR DE ENCAIXE

Com função de puxador, são voltados para aplicação em portas, gavetas e demais peças que contam com o movimento de abrir/fechar.

## ACABAMENTOS & CORES

**Natural**

**Anodizado**

Fosco | Bronze 1001 | 1002 | 1003 | Preto

**Jateado e Anodizado**

Fosco | Bronze 1001 | 1002 | 1003 | Preto

**Escovado e Anodizado**

Inox | Preto

**Pintura Eletrostática**

**DES-009**

PUXADOR ENCAIXE - MDF 18 mm  
0,336 Kg/m

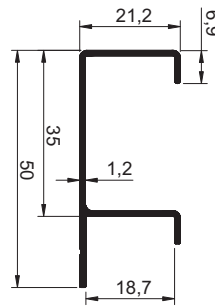

**DES-264**

PUXADOR ENCAIXE - MDF 18mm  
0,367Kg/m

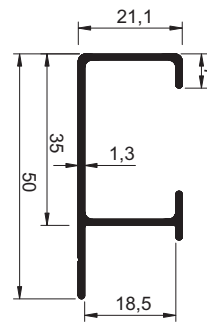

**DES-960**

PUXADOR ENCAIXE - MDF 18mm  
0,319 Kg/m

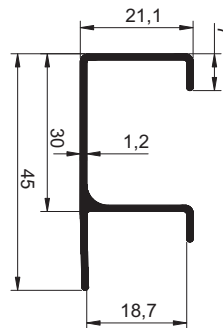

**DES-074**

PUXADOR ENCAIXE - MDF 18 mm  
0,446 Kg/m

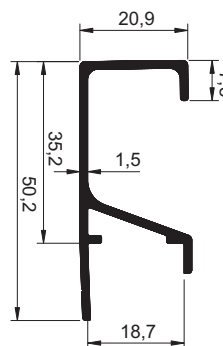

A ALUMICONTE reserva-se o direito de fazer modificações em qualquer informação escrita neste catálogo sem aviso prévio. Os desenhos aqui contidos possuem medidas teóricas de massa e tolerâncias dimensionais de acordo com a ABNT NBR-8116, podendo haver variações dessas informações no produto final.

## DES-202

PUXADOR ENCAIXE - MDF 18mm

0,517 Kg/m

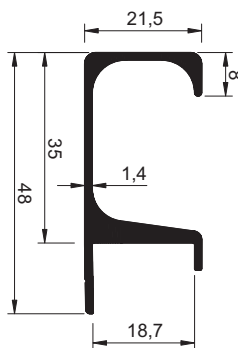

## DES-212

PUXADOR ENCAIXE - MDF 18 mm

0,432 Kg/m

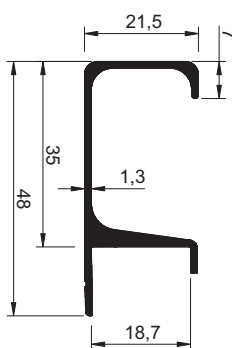

## DES-275

PUXADOR ENCAIXE - MDF 18mm

0,456 Kg/m

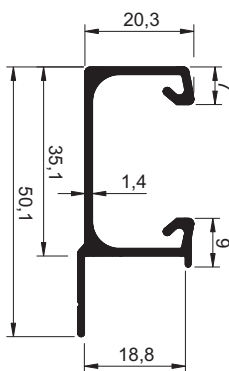

### PONTEIRAS COMPATÍVEIS

BRANCO | BRONZE | CROMO  
FOSCO | INOX | PRETO

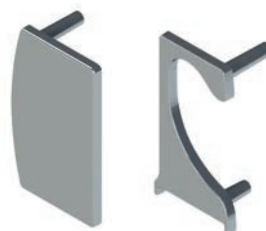

## DES-089

PUXADOR ENCAIXE - MDF 18mm

0,461 Kg/m

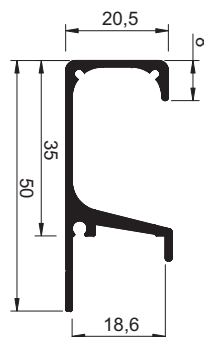

### DES-385

PUXADOR ENCAIXE - MDF 18 mm

0,469 Kg/m

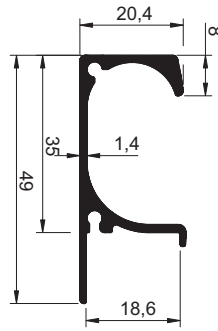

PONTEIRA COMPATÍVEL

BRANCO | BRONZE | CROMO  
FOSCO | INOX | PRETO



### DES-620

PUXADOR ENCAIXE - MDF 18 mm

0,461 Kg/m

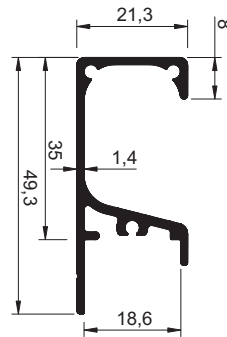

PONTEIRAS COMPATÍVEIS

BRANCO | BRONZE | CROMO  
FOSCO | INOX | PRETO

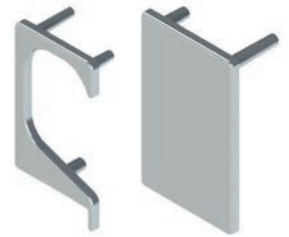

### DES-102

PUXADOR ENCAIXE - 18 mm

0,456 Kg/m

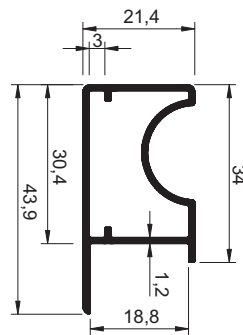
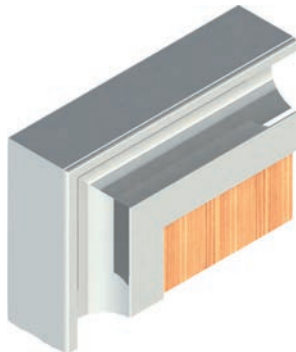

### DES-1400

PUXADOR ENCAIXE - MDF 18mm

0,386 Kg/m

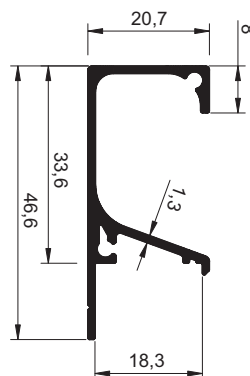

PONTEIRA COMPATÍVEL

PRETO | BRANCO | CROMO  
BRONZE | FOSCO | INOX



## DES-197

PUXADOR ENCAIXE - MDF 18mm

0,431 Kg/m

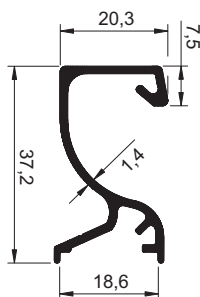

PONTEIRAS COMPATÍVEIS

BRANCO | BRONZE | CROMO  
FOSCO | INOX | PRETO

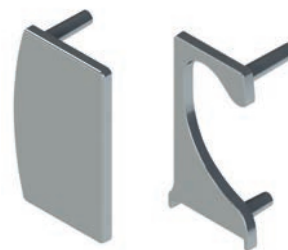

## DES-201

PUXADOR ENCAIXE - MDF 18mm

0,456 Kg/m

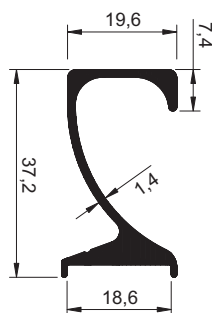

## DES-931

PUXADOR ENCAIXE - MDF 18mm

0,581 Kg/m

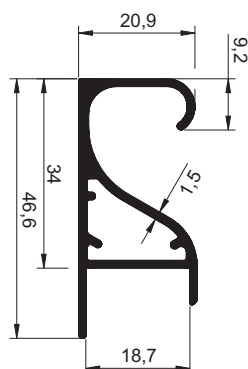

## DES-949

PUXADOR ENCAIXE - MDF 18 mm

0,469 Kg/m

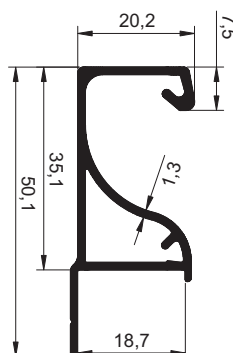

### DES-999

PUXADOR ENCAIXE - MDF 18mm  
0,433 Kg/m

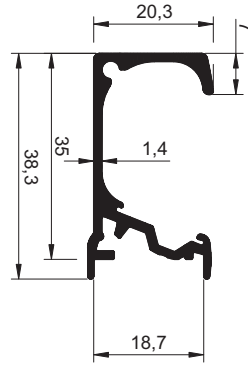

**PONTEIRA COMPATÍVEL**  
BRANCO | BRONZE | CROMO  
FOSCO | INOX | PRETO



### DES-1063

PUXADOR ENCAIXE - MDF 18 mm  
0,462 Kg/m

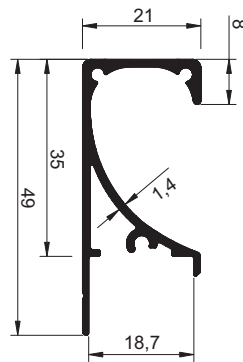

**PONTEIRAS COMPATÍVEIS**  
BRANCO | BRONZE | CROMO  
FOSCO | INOX | PRETO

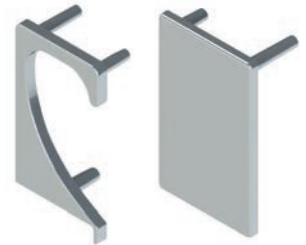

### DES-1069

BASE CLICK PERFIL ENCAIXE DES-1068  
0,121 Kg/m

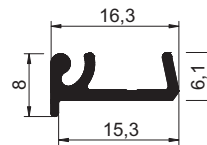

### DES-1068

PUXADOR ENCAIXE - MDF 18mm  
0,386 Kg/m

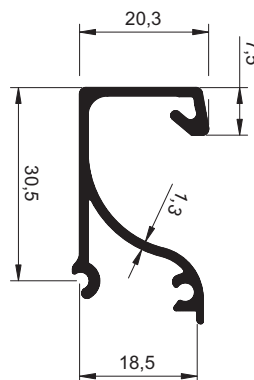

A ALUMICONTE reserva-se o direito de fazer modificações em qualquer informação escrita neste catálogo sem aviso prévio. Os desenhos aqui contidos possuem medidas teóricas de massa e tolerâncias dimensionais de acordo com a ABNT NBR-8116, podendo haver variações dessas informações no produto final.

## DES-923

PUXADOR ENCAIXE

0,259 Kg/m

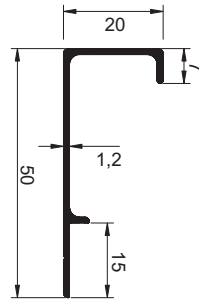

## DES-173

PUXADOR ENCAIXE - MDF 18mm

0,437 Kg/m

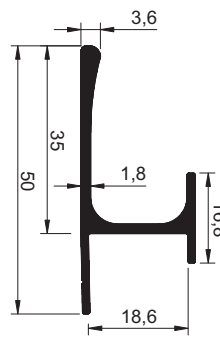

## DES-404

PUXADOR ENCAIXE - MDF 18mm

0,327 Kg/m

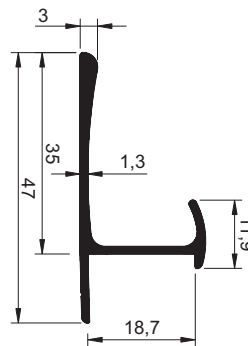

## DES-224

PUXADOR ENCAIXE 45° - MDF 18mm

0,378 Kg/m

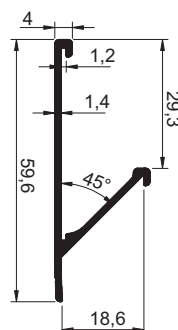



### DES-1404

PUXADOR ENCAIXE 45° - MDF 18 mm

0,379 Kg/m

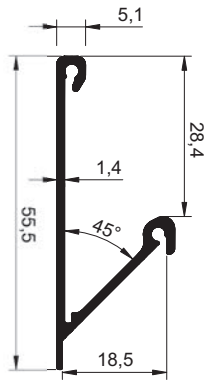

### DES-1432

PUXADOR ENCAIXE 45° - MDF 18 mm

0,428 Kg/m

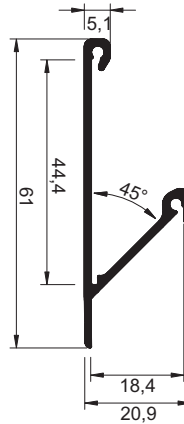

PONTEIRAS COMPATÍVEIS

BRANCO | BRONZE | CROMO  
FOSCO | INOX | PRETO



### DES-878

PUXADOR ENCAIXE 45° - MDF 18mm

0,353 Kg/m

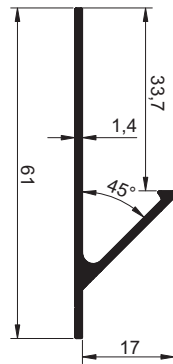

### DES-305

PUXADOR ENCAIXE - 30° - MDF 18mm

0,508 Kg/m

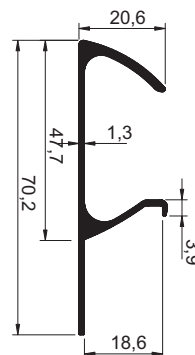

## DES-108

PUXADOR ENCAIXE - MDF 18mm C/ ESPIGA  
0,500 Kg/m

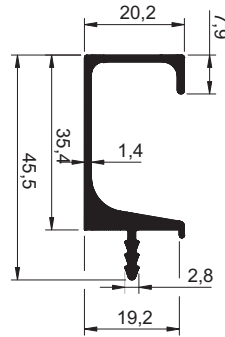

## DES-132

PUXADOR ENCAIXE - MDF 18mm C/ ESPIGA  
0,439 Kg/m

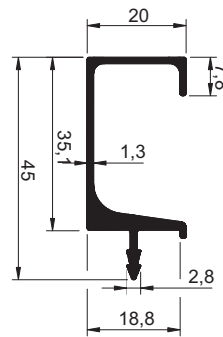

## DES-142

PUXADOR ENCAIXE - MDF 18mm C/ ESPIGA  
0,497 Kg/m

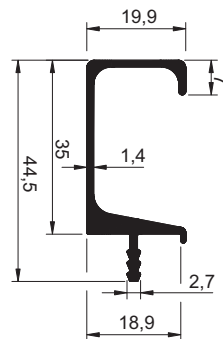

## DES-314

PUXADOR ENCAIXE - MDF 18mm C/ ESPIGA  
0,476 Kg/m

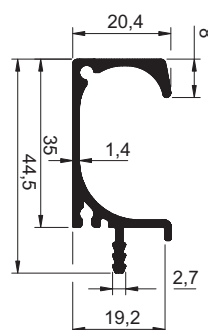

### PONTEIRA COMPATÍVEL

BRANCO | BRONZE | CROMO  
FOSCO | INOX | PRETO



### DES-337

PUXADOR ENCAIXE - 18mm C/ ESPIGA  
0,502 Kg/m

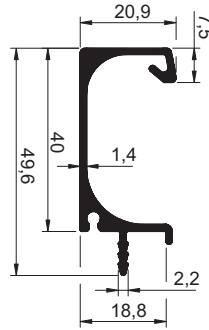

### DES-611

PUXADOR ENCAIXE - MDF 18mm C/ ESPIGA  
0,437 Kg/m

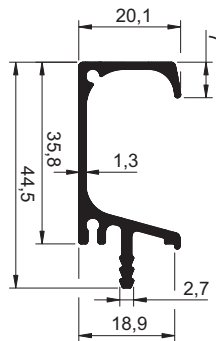

**PONTEIRA COMPATÍVEL**  
BRANCO | BRONZE | CROMO  
FOSCO | INOX | PRETO



### DES-266

PUXADOR ENCAIXE - MDF 18 mm C/ ESPIGA  
0,390 Kg/m

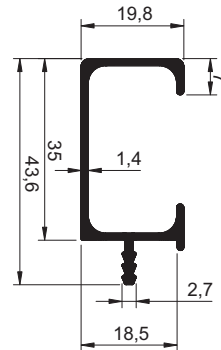

### DES-022

PUXADOR ENCAIXE - MDF 18 mm C/ ESPIGA  
0,438 Kg/m

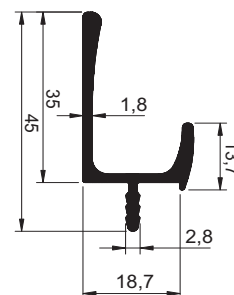

A ALUMICONTE reserva-se o direito de fazer modificações em qualquer informação escrita neste catálogo sem aviso prévio. Os desenhos aqui contidos possuem medidas teóricas de massa e tolerâncias dimensionais de acordo com a ABNT NBR-8116, podendo haver variações dessas informações no produto final.

## DES-192

PUXADOR ENCAIXE - 30° - MDF 18 mm C/ ESPIGA

0,403 Kg/m

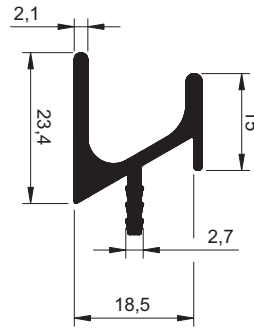

## DES-094

PUXADOR ENCAIXE 30° - MDF 18mm C/ ESPIGA

0,392 Kg/m

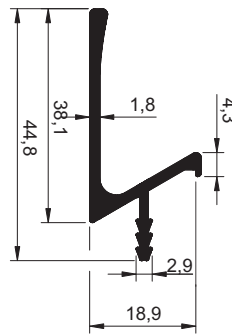
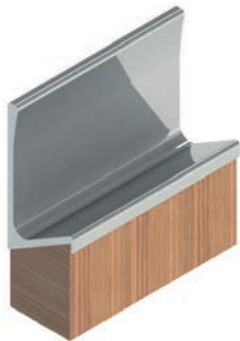

## DES-1272

PUXADOR ENCAIXE MDF 18mm C/ESPIGA

0,347 Kg/m

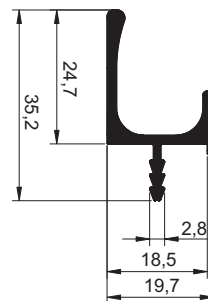

## DES-622

PUXADOR ENCAIXE C/ ESPIGA

0,505 Kg/m

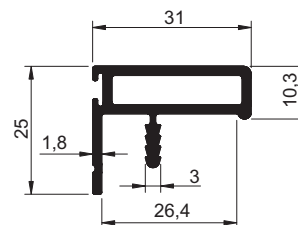

### DES-623

PUXADOR ENCAIXE C/ ESPIGA  
0,745 Kg/m

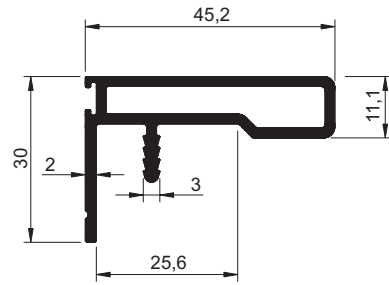
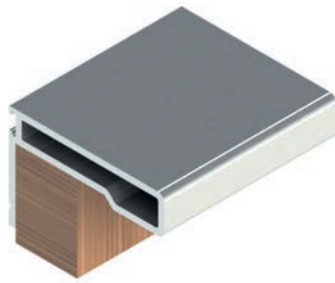

### DES-885

PUXADOR ENCAIXE C/ ESPIGA  
0,377Kg/m

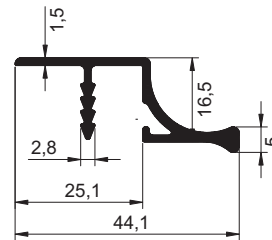

### DES-1273

PUXADOR ENCAIXE MDF 18mm C/ ESPIGA  
0,290 Kg/m

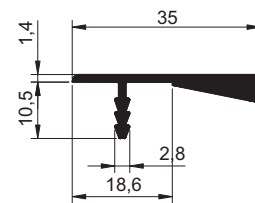
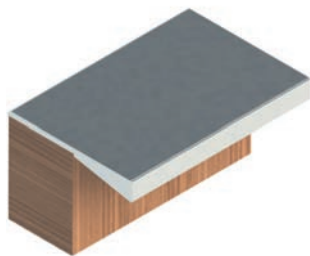

### DES-1696

PERFIL PUXADOR C/ ESPIGA - MDF 18mm  
0,268 Kg/m

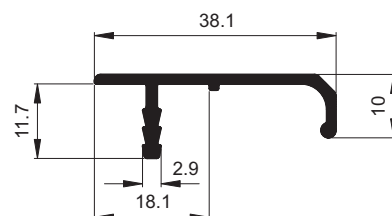
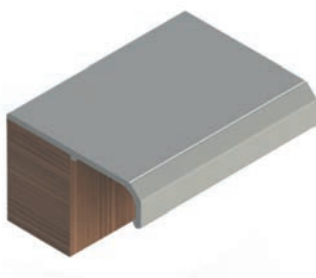

A ALUMICONTE reserva-se o direito de fazer modificações em qualquer informação escrita neste catálogo sem aviso prévio. Os desenhos aqui contidos possuem medidas teóricas de massa e tolerâncias dimensionais de acordo com a ABNT NBR-8116, podendo haver variações dessas informações no produto final.

## DES-1465

PUXADOR ENCAIXE ESPIGA DUPLA - MDF 18mm

0,406 Kg/m

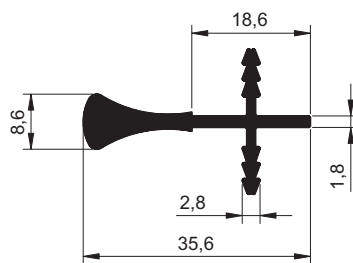

## DES-883

PUXADOR EMBUTIR C/ ESPIGA | 23mm

0,726 Kg/m

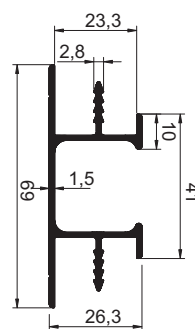



**DES-213**

PUXADOR ENCAIXE - MDF 15mm  
0,392 Kg/m

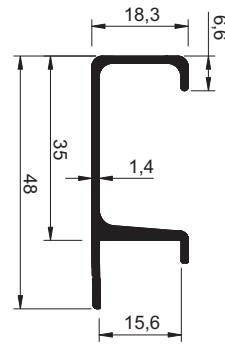

**DES-270**

PUXADOR ENCAIXE - MDF 15mm  
0,315 Kg/m

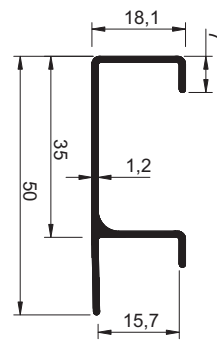

**DES-339**

PUXADOR ENCAIXE - MDF 15mm  
0,298 Kg/m

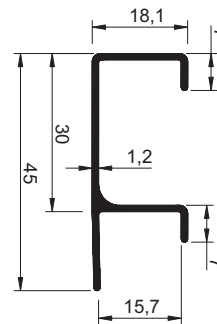

**DES-214**

PUXADOR ENCAIXE - MDF 15mm  
0,498 Kg/m

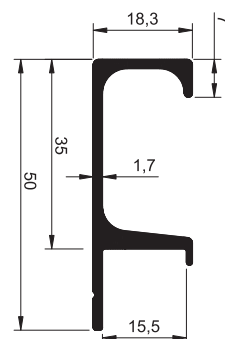



### DES-284

PUXADOR ENCAIXE - MDF 15 mm  
0,381 Kg/m

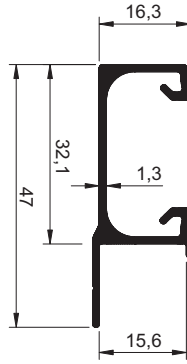

#### PONTEIRA COMPATÍVEL

BRANCO | BRONZE | CROMO  
FOSCO | INOX | PRETO



### DES-621

PUXADOR ENCAIXE - MDF 15mm  
0,430 Kg/m

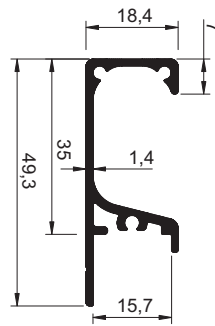

#### PONTEIRAS COMPATÍVEIS

BRANCO | BRONZE | CROMO  
FOSCO | INOX | PRETO

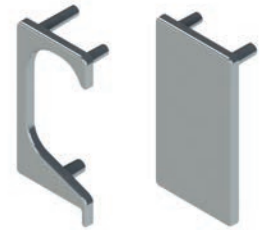

### DES-970

PUXADOR ENCAIXE - MDF 15mm  
0,353 Kg/m

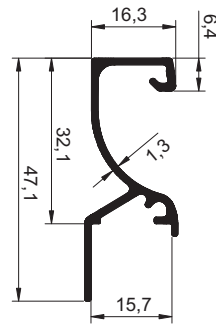

#### PONTEIRAS COMPATÍVEIS

BRANCO | BRONZE | CROMO  
FOSCO | INOX | PRETO

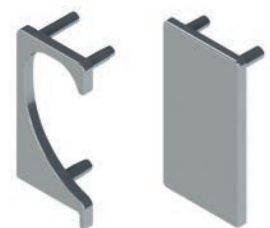

### DES-1062

PUXADOR ENCAIXE - MDF 15mm  
0,461 Kg/m

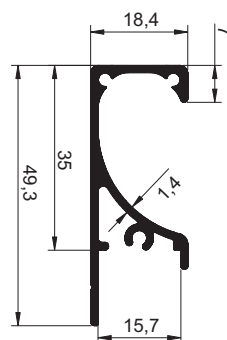

#### PONTEIRAS COMPATÍVEIS

BRANCO | BRONZE | CROMO  
FOSCO | INOX | PRETO

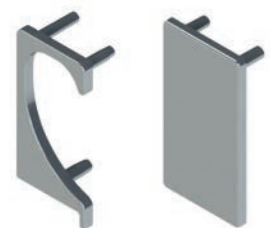

## DES-1077

PUXADOR ENCAIXE - 15 mm

0,324 Kg/m

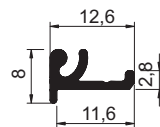
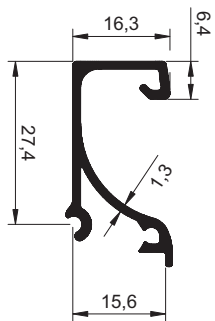

## DES-1078

BASE CLICK PERFIL ENCAIXE

DES-1077

0,092 Kg/m



## DES-1401

PUXADOR ENCAIXE - MDF 15mm

0,354 Kg/m

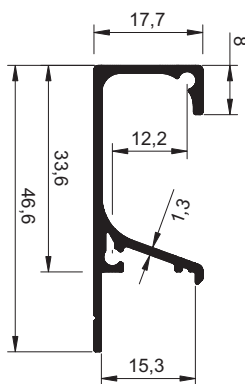

### PONTEIRAS COMPATÍVEIS

BRANCO | BRONZE | CROMO  
FOSCO | INOX | PRETO



## DES-312

PUXADOR ENCAIXE - MDF 15mm

0,323 Kg/m

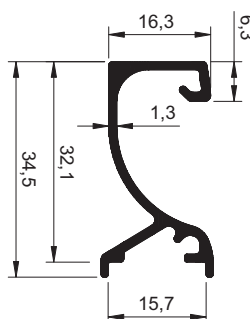

### PONTEIRA COMPATÍVEL

BRANCO | BRONZE | CROMO  
FOSCO | INOX | PRETO



## DES-162

PUXADOR ENCAIXE - MDF 15mm

0,464 Kg/m

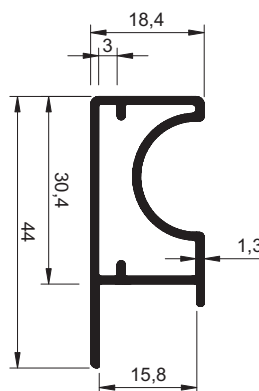

### DES-194

PUXADOR ENCAIXE - MDF 15 mm  
0,517 Kg/m

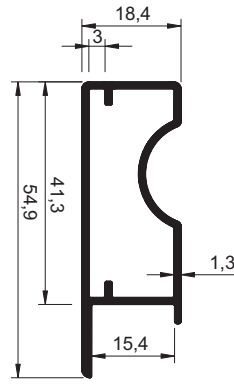

### DES-222

PUXADOR ENCAIXE - MDF 15 mm  
0,384 Kg/m

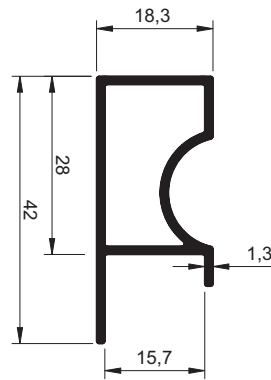
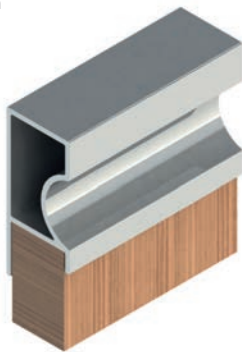

### DES-234

PUXADOR ENCAIXE - MDF 15mm  
0,265 Kg/m

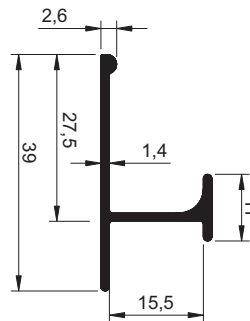

### DES-1011

PUXADOR ENCAIXE - MDF 15mm  
0,273 Kg/m

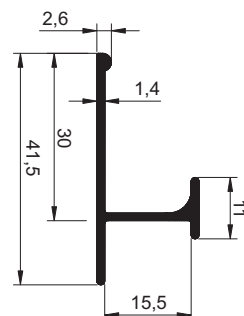

A ALUMICONTE reserva-se o direito de fazer modificações em qualquer informação escrita neste catálogo sem aviso prévio. Os desenhos aqui contidos possuem medidas teóricas de massa e tolerâncias dimensionais de acordo com a ABNT NBR-8116, podendo haver variações dessas informações no produto final.

### DES-345

PUXADOR ENCAIXE - MDF 15mm

0,273 Kg/m

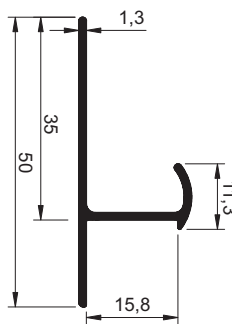

### DES-238

PUXADOR ENCAIXE - MDF 15mm C/ ESIPIGA

0,395 Kg/m

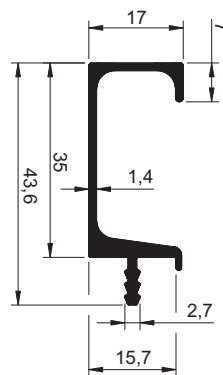

### DES-265

PUXADOR ENCAIXE - MDF 15mm C/ ESIPIGA

0,369 Kg/m

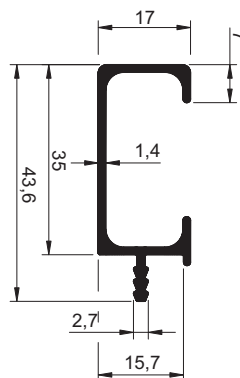

### DES-1322

PUXADOR ENCAIXE - MDF 15mm C/ ESIPIGA

0,412 Kg/m

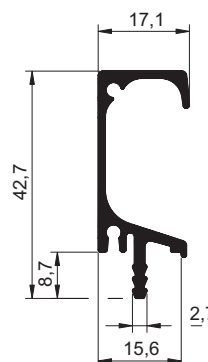

### DES-221

PUXADOR ENCAIXE - MDF 15mm C/ ESPIGA

0,279 Kg/m

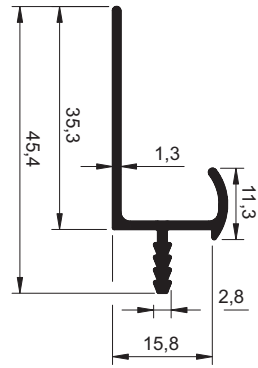

### DES-933

PUXADOR ENCAIXE 45° - MDF 15 mm

0,352Kg/m

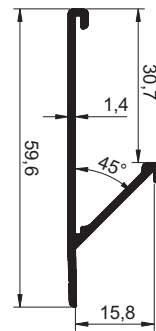

### DES-1405

PUXADOR ENCAIXE 45° - MDF 15mm

0,363 Kg/m

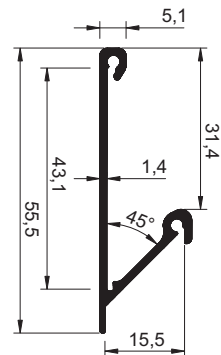

### DES-1431

PUXADOR ENCAIXE 45° - MDF 15mm

0,411 Kg/m

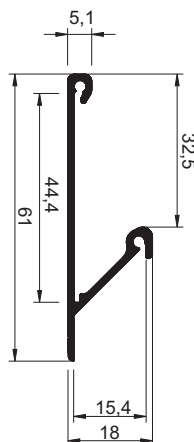

**PONTEIRA COMPATÍVEL**  
BRANCO | BRONZE | CROMO  
FOSCO | INOX | PRETO



# PUXADOR

## DES-043

PUXADOR ENCAIXE - 23mm  
0,304 Kg/m

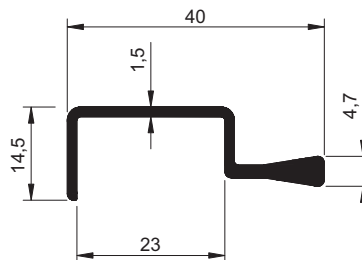

COMPATÍVEL · MONTAGEM

**DES-233** **DES-1326**  
**DES-297** **DES-1466**  
**DES-832** **DES-1612**  
**DES-902**

## DES-239

PUXADOR ENCAIXE  
0,289 Kg/m

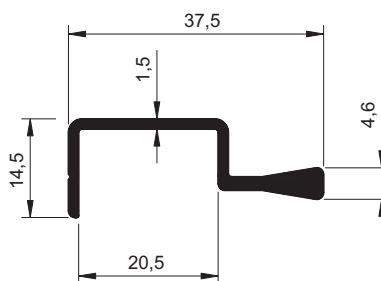

COMPATÍVEL · MONTAGEM

**DES-007** **DES-721**  
**DES-008** **DES-875**  
**DES-014** **DES-926**  
**DES-130** **DES-1264**  
**DES-198**

## DES-519

PUXADOR ENCAIXE - 18mm  
0,282 Kg/m

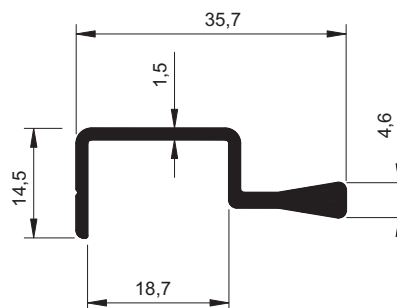

COMPATÍVEL · MONTAGEM

**DES-084** **DES-1250**  
**DES-300** **DES-1443**  
**DES-1070**

## DES-1613

PUXADOR ENCAIXE - 23mm  
0,375 Kg/m

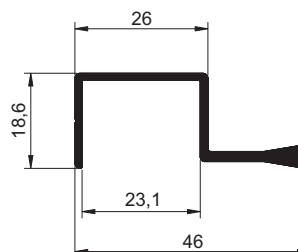
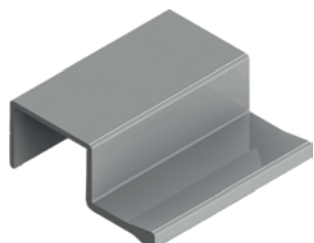

COMPATÍVEL · MONTAGEM

**DES-002**

### DES-1614

PUXADOR ENCAIXE - 18mm  
0,357 Kg/m

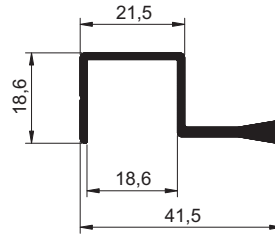

COMPATÍVEL · MONTAGEM  
**DES-300**  
**DES-912**

### DES-1615

PUXADOR ENCAIXE - 15mm  
0,346 Kg/m

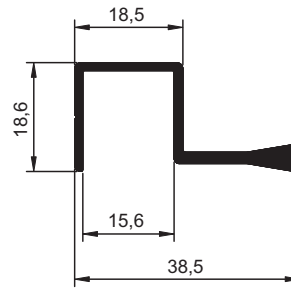
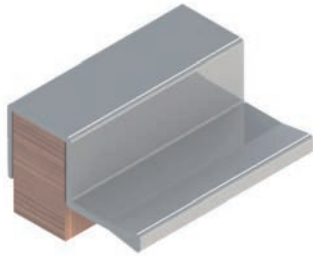

### DES-1420

PUXADOR ENCAIXE  
0,368 Kg/m

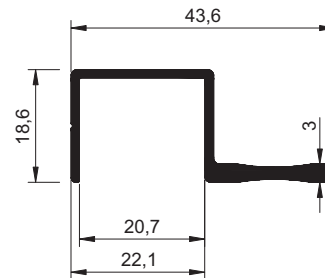
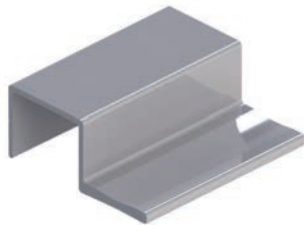

### DES-1421

PUXADOR ENCAIXE  
0,360 Kg/m

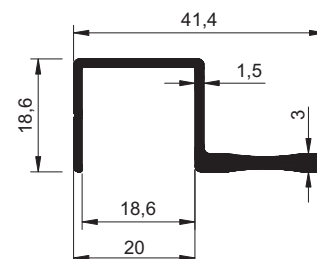
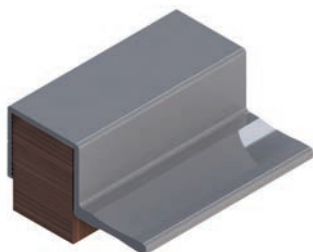

A ALUMICONTE reserva-se o direito de fazer modificações em qualquer informação escrita neste catálogo sem aviso prévio. Os desenhos aqui contidos possuem medidas teóricas de massa e tolerâncias dimensionais de acordo com a ABNT NBR-8116, podendo haver variações dessas informações no produto final.

## DES-1251

PUXADOR ENCAIXE

0,274 Kg/m

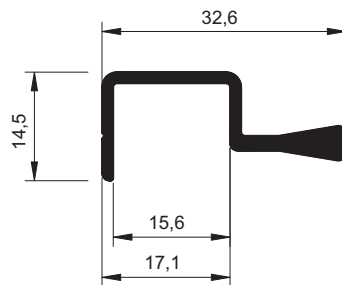
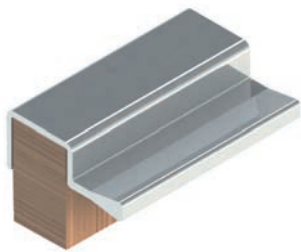

## DES-1252

PUXADOR ENCAIXE

0,262 Kg/m

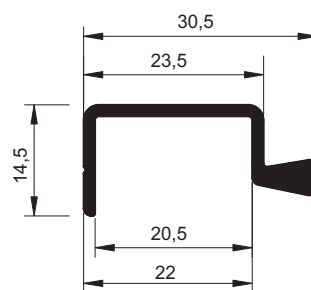
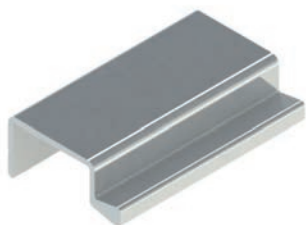

COMPATÍVEL · MONTAGEM

**DES-010**

**DES-014**

**DES-130**

**DES-198**

## DES-1280

PUXADOR ENCAIXE

0,382 Kg/m

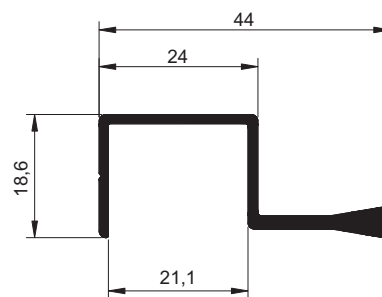
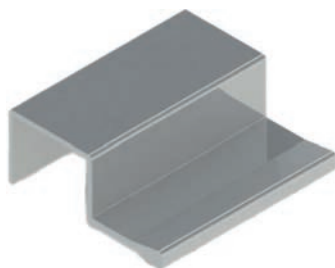

COMPATÍVEL · MONTAGEM

**DES-010 | DES-130**

## DES-112

PUXADOR ENCAIXE

0,316 Kg/m

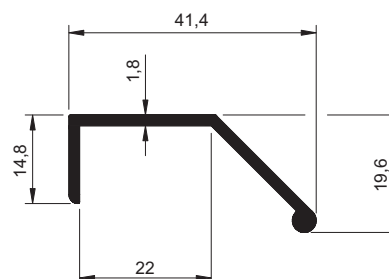
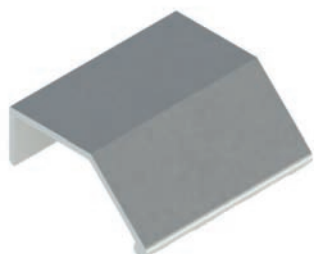

COMPATÍVEL · MONTAGEM

**DES-001 DES-233**

**DES-002 DES-297**

**DES-131 DES-902**

**DES-198 DES-1612**



### DES-695

PUXADOR ENCAIXE - 18mm  
0,311 Kg/m

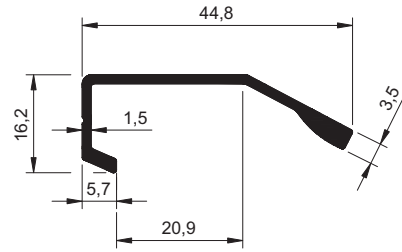
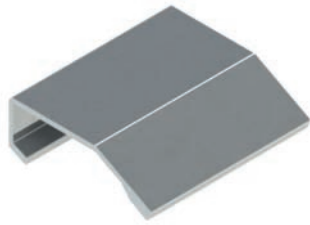

### DES-833

PUXADOR ENCAIXE  
0,320 Kg/m

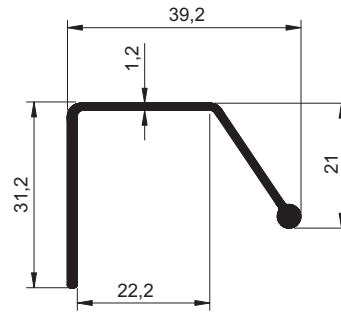

COMPATÍVEL · MONTAGEM

**DES-002**

**DES-020**

**DES-902**

**DES-1612**

### DES-842

PUXADOR ENCAIXE  
0,242 Kg/m

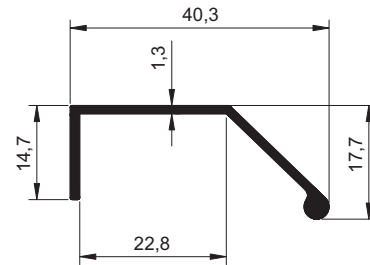
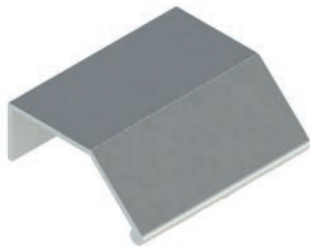

COMPATÍVEL · MONTAGEM

**DES-001** **DES-297**

**DES-002** **DES-902**

**DES-020** **DES-1612**

**DES-233**

### DES-144

PUXADOR ENCAIXE  
0,260 Kg/m

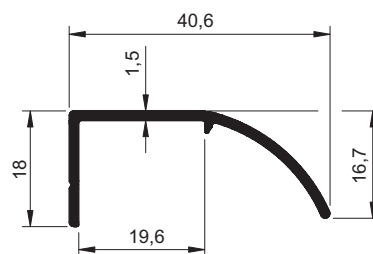
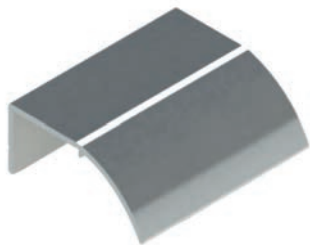

COMPATÍVEL · MONTAGEM

**DES-073**

**DES-147**

## DES-145

PUXADOR ENCAIXE

0,267 Kg/m

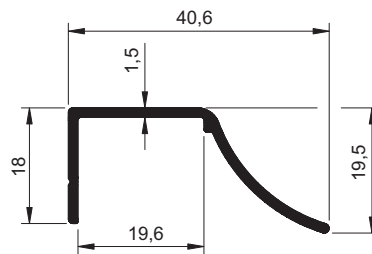
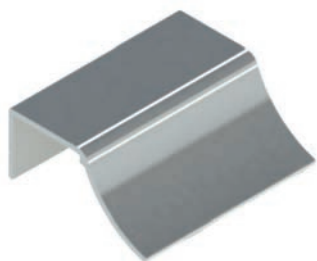

COMPATÍVEL · MONTAGEM

**DES-073**

**DES-147**

**DES-951**

## DES-296

PUXADOR ENCAIXE

0,246 Kg/m

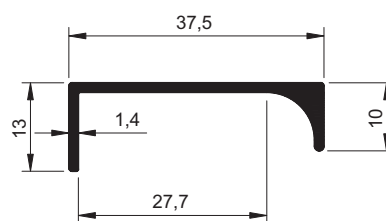
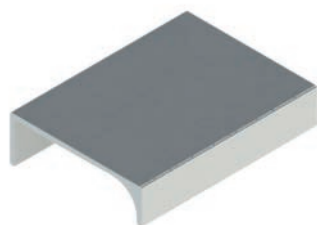

## DES-395

PUXADOR ENCAIXE

0,293 Kg/m

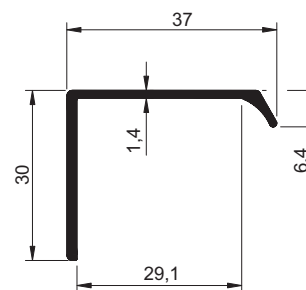
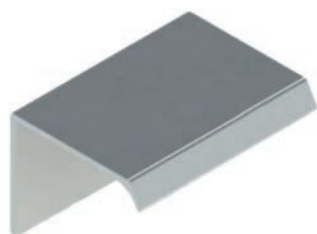

## DES-908

PUXADOR ENCAIXE

0,434 Kg/m

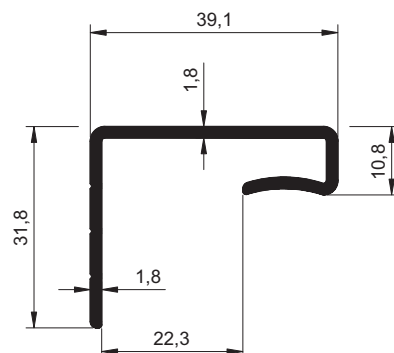
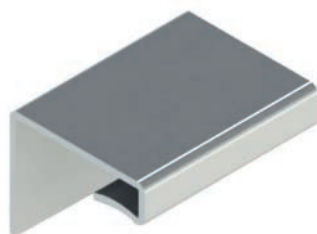

COMPATÍVEL · MONTAGEM

**DES-297**

**DES-832**

**DES-902**

**DES-1326**

**DES-1319**

PUXADOR ENCAIXE  
0,372 Kg/m

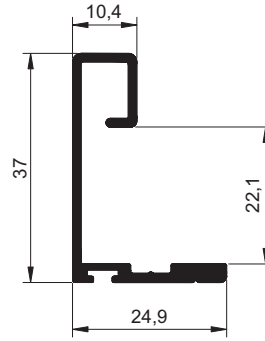

**DES-1329**

PUXADOR ENCAIXE  
0,364 Kg/m

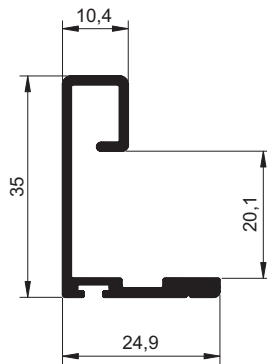

**DES-1332**

PUXADOR ENCAIXE  
0,383 Kg/m

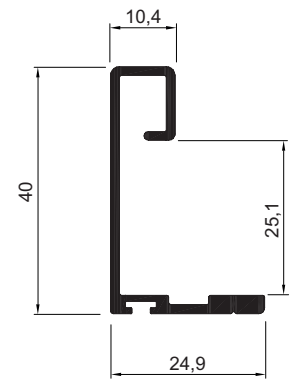

**DES-203**

PUXADOR ENCAIXE - 15mm  
0,259 Kg/m

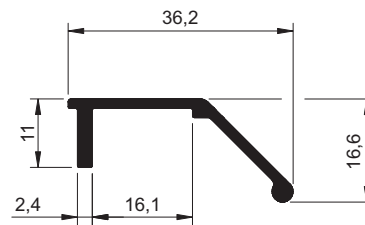
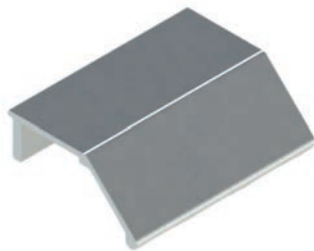

COMPATÍVEL · MONTAGEM

- DES-010**
- DES-130**
- DES-198**
- DES-311**
- DES-691**

**DES-909**

PUXADOR ENCAIXE  
0,279 Kg/m

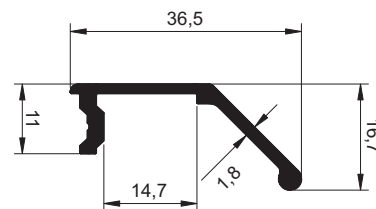
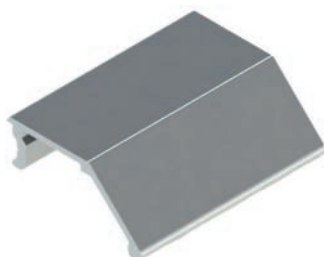

COMPATÍVEL · MONTAGEM

- DES-073**

A ALUMICONTE reserva-se o direito de fazer modificações em qualquer informação escrita neste catálogo sem aviso prévio. Os desenhos aqui contidos possuem medidas teóricas de massa e tolerâncias dimensionais de acordo com a ABNT NBR-8116, podendo haver variações dessas informações no produto final.

## DES-993

PUXADOR ENCAIXE

0,214 Kg/m

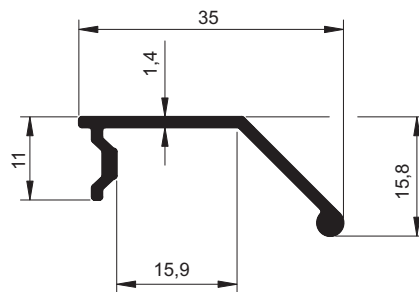
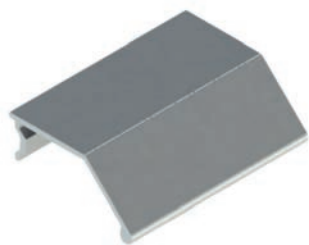

COMPATÍVEL · MONTAGEM

**DES-131**

## DES-1278

PUXADOR ENCAIXE

0,268 Kg/m

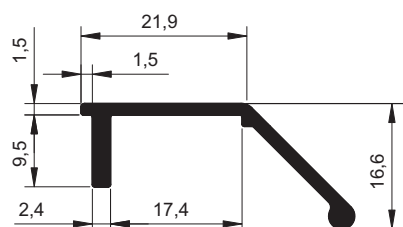
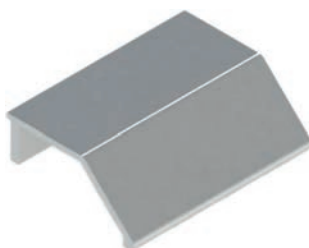

COMPATÍVEL · MONTAGEM

**DES-131**

**DES-233**

**DES-297**

## DES-148

PUXADOR ENCAIXE INTERNO

0,245 Kg/m

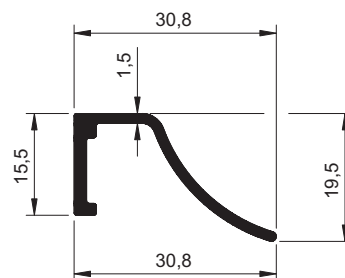

## DES-149

PUXADOR ENCAIXE INTERNO

0,238 Kg/m

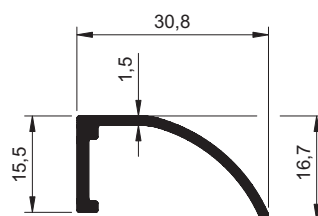

### DES-1013

PUXADOR ENCAIXE  
0,308 Kg/m

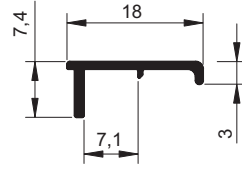

### DES-901

PUXADOR ENCAIXE  
0,235 Kg/m

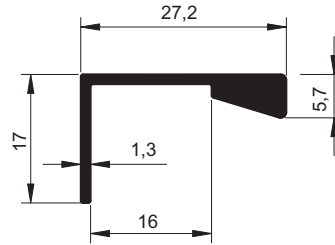
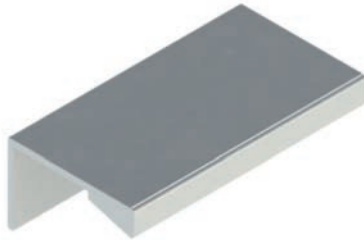

### DES-1299

PUXADOR ENCAIXE  
0,261 Kg/m

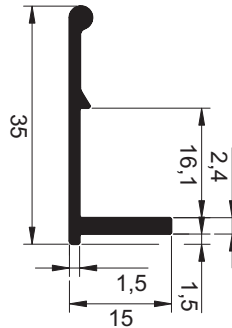

COMPATÍVEL · MONTAGEM

DES-010 DES-311  
DES-062 DES-691  
DES-130 DES-875  
DES-198

### DES-1324

PUXADOR ENCAIXE  
0,236 Kg/m

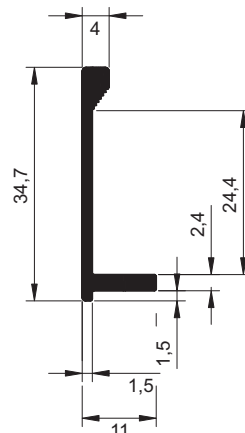

COMPATÍVEL · MONTAGEM

DES-010 DES-233  
DES-062 DES-311  
DES-130 DES-691  
DES-131 DES-875  
DES-198

A ALUMICONTE reserva-se o direito de fazer modificações em qualquer informação escrita neste catálogo sem aviso prévio. Os desenhos aqui contidos possuem medidas teóricas de massa e tolerâncias dimensionais de acordo com a ABNT NBR-8116, podendo haver variações dessas informações no produto final.

**DES-063**

PUXADOR DE EMBUTIR

0,440 Kg/m

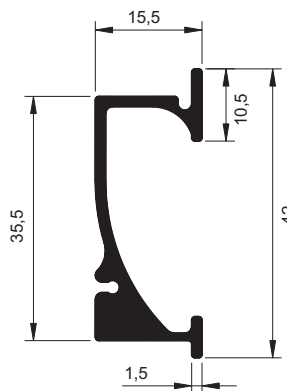

**DES-064**

PUXADOR EMBUTIR

0,366Kg/m

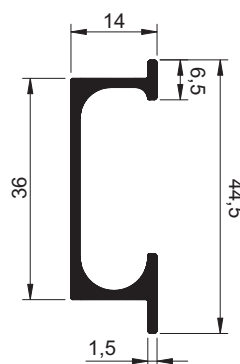
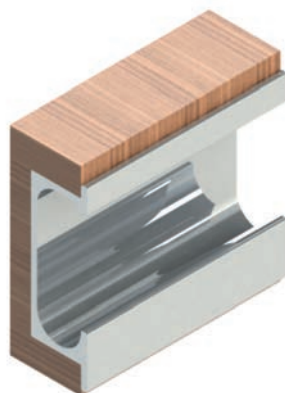

**DES-046**

PUXADOR EMBUTIR

0,112 Kg/m

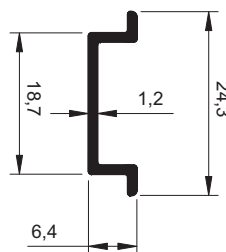
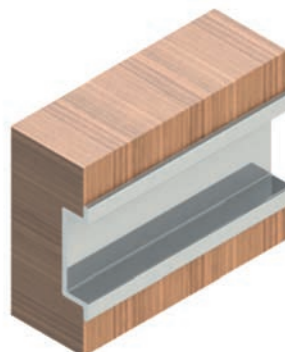

**DES-347**

PUXADOR EMBUTIR

0,354 Kg/m

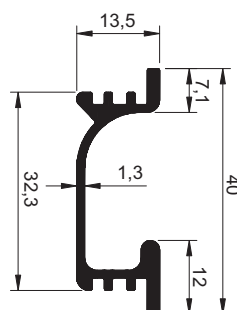

### DES-881

PUXADOR EMBUTIR

0,383 Kg/m

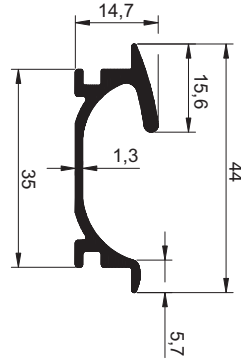

PONTEIRA COMPATÍVEL

CROMO | FOSCO | INOX



### DES-1423

PUXADOR EMBUTIR

0,275 Kg/m

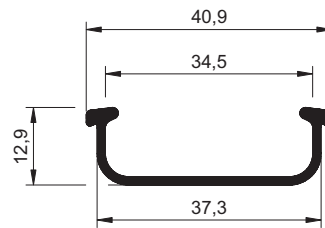

### DES-088

PUXADOR FRONTAL

0,317 Kg/m

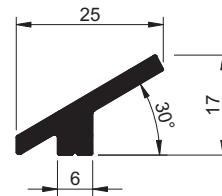

### DES-090

PUXADOR FRONTAL

0,312 Kg/m

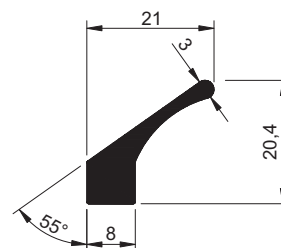

A ALUMICONTE reserva-se o direito de fazer modificações em qualquer informação escrita neste catálogo sem aviso prévio. Os desenhos aqui contidos possuem medidas teóricas de massa e tolerâncias dimensionais de acordo com a ABNT NBR-8116, podendo haver variações dessas informações no produto final.

## DES-175

PUXADOR FRONTAL  
0,556 Kg/m

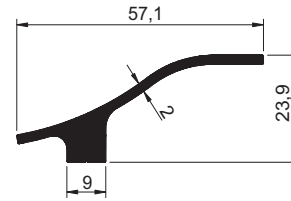
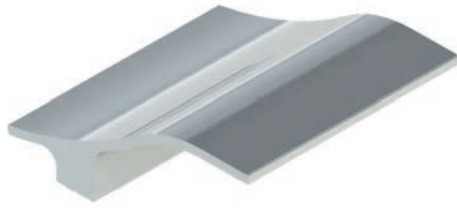

## DES-680

PUXADOR FRONTAL  
0,327 Kg/m

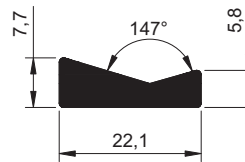
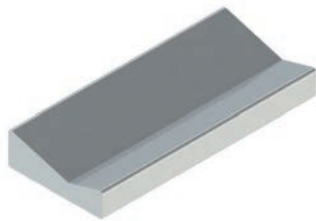

## DES-826

PUXADOR FRONTAL  
0,244 Kg/m

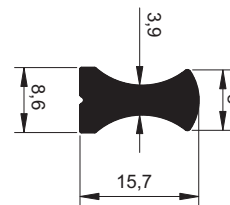

## DES-872

PUXADOR FRONTAL  
4,708 Kg/m

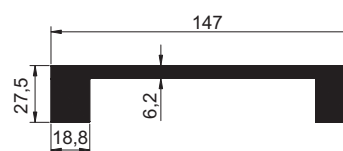
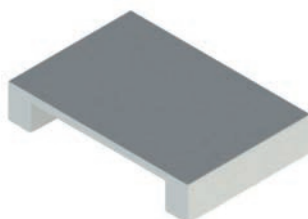



### DES-879

PUXADOR FRONTAL  
0,495 Kg/m

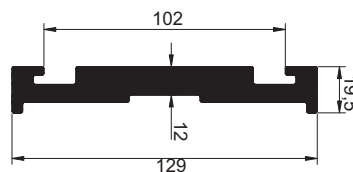
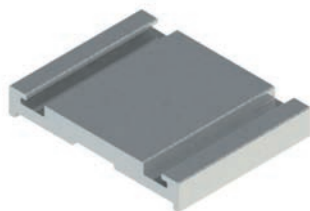

### DES-976

PUXADOR FRONTAL T  
0,458 Kg/m

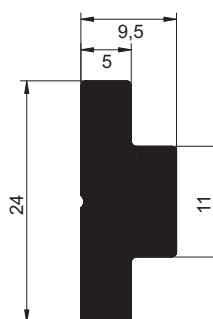

### DES-232

PUXADOR ENCAIXE INTERNO 11mm  
0,151 Kg/m

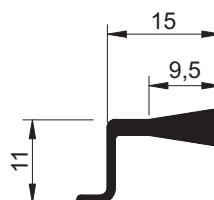

### DES-353

PUXADOR ENCAIXE INTERNO 11mm  
0,209 Kg/m

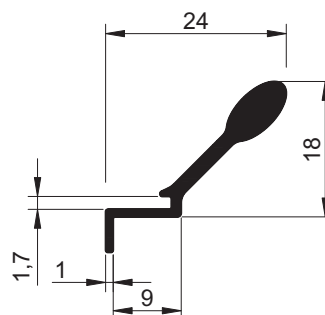

COMPATÍVEL · MONTAGEM  
**DES-233**

# PERFIL PARA QUADRO DE VIDRO

Com função de estruturar o quadro e receber a folha de vidro, esses perfis podem ser aplicados em diversas posições, de acordo com cada projeto.

## ACABAMENTOS & CORES

**Natural**

**Anodizado**

Fosco | Bronze 1001 | 1002 | 1003 | Preto

**Jateado e Anodizado**

Fosco | Bronze 1001 | 1002 | 1003 | Preto

**Escovado e Anodizado**

Inox | Preto

**Pintura Eletrostática**

### DES-001

QUADRO VIDRO  
0,466 Kg/m  
22,3 x 45 x 5,2 mm

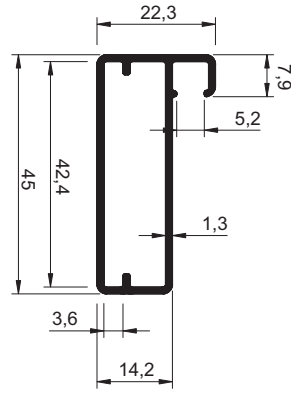

COMPATÍVEL · MONTAGEM

**DES-158**

COMPATÍVEL · PUXADOR

**DES-112**

**DES-842**

### DES-002

QUADRO VIDRO - 6,2mm  
0,798 Kg/m  
23 x 70 x 6,2 mm

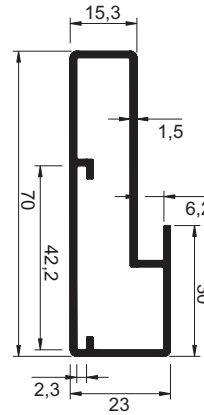
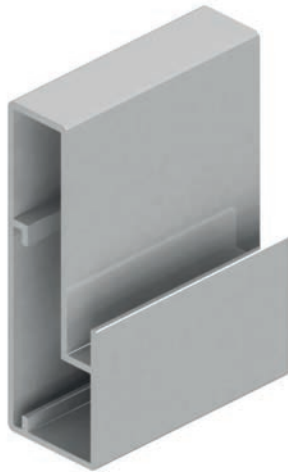

COMPATÍVEL · PUXADOR

**DES-112**

**DES-833**

**DES-842**

**DES-1613**

### DES-007

QUADRO VIDRO - 5,0mm  
0,508 Kg/m  
20,4 x 48,2 x 5 mm

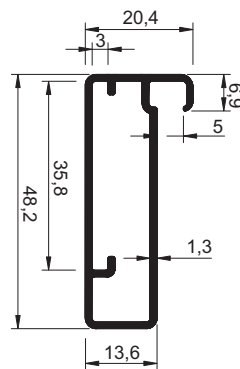

COMPATÍVEL · PUXADOR

**DES-239**

### DES-008

QUADRO VIDRO - 4,9mm  
0,576 Kg/m  
20,4 x 48,2 x 4,9 mm

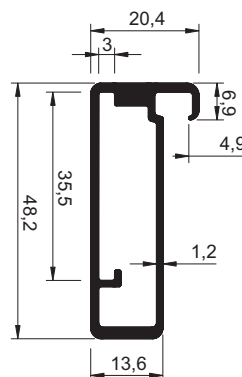

COMPATÍVEL · PUXADOR

**DES-239**

A ALUMICONTE reserva-se o direito de fazer modificações em qualquer informação escrita neste catálogo sem aviso prévio. Os desenhos aqui contidos possuem medidas teóricas de massa e tolerâncias dimensionais de acordo com a ABNT NBR-8116, podendo haver variações dessas informações no produto final.

### DES-010

QUADRO VIDRO - 5,2mm  
 0,482 Kg/m  
 20,1 x 45 x 5,2 mm

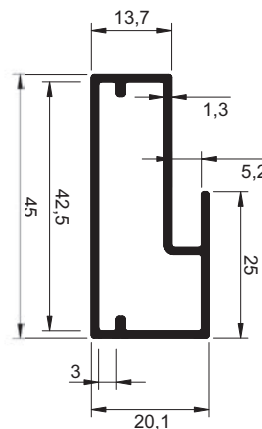

COMPATÍVEL · PUXADOR

- DES-203**
- DES-1252**
- DES-1280**
- DES-1299**
- DES-1324**

### DES-014

QUADRO VIDRO - 4,5mm  
 0,459 Kg/m  
 19,8 x 42 x 4,5 mm

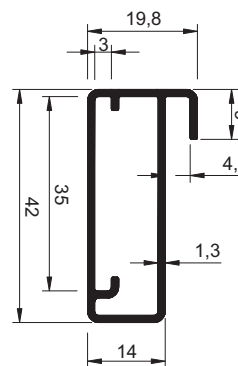

COMPATÍVEL · PUXADOR

- DES-239**
- DES-1252**

### DES-832

QUADRO VIDRO  
 0,688 Kg/m  
 69 x 22 x 6,2 mm

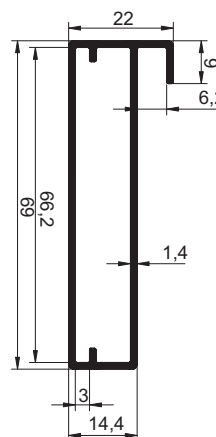

### DES-062

QUADRO VIDRO  
 0,455 Kg/m  
 20 x 45 x 6,7 mm

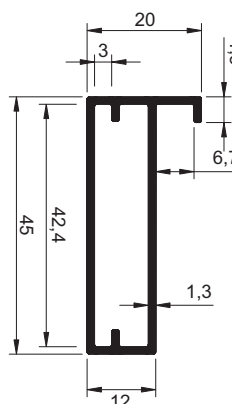
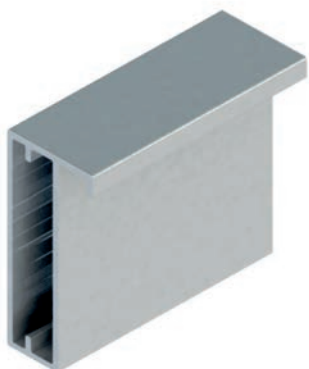

COMPATÍVEL · PUXADOR

- DES-1299**
- DES-1324**

### DES-084

QUADRO VIDRO  
0,407 Kg/m  
18 x 44,2 x 4,6 mm

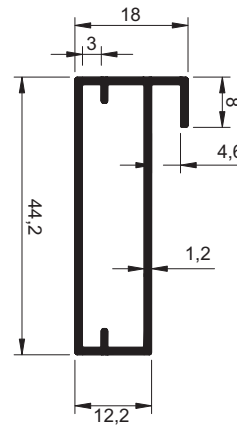

COMPATÍVEL · PUXADOR  
**DES-519**

### DES-133

QUADRO VIDRO  
0,508 Kg/m  
18,1 x 47 x 3,6 mm

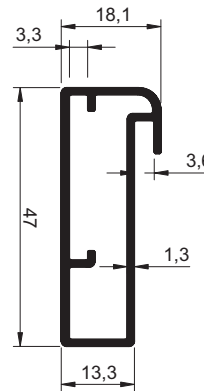

### DES-198

QUADRO VIDRO - 4,5mm  
0,461 Kg/m  
20,3 x 45 x 4,5 mm

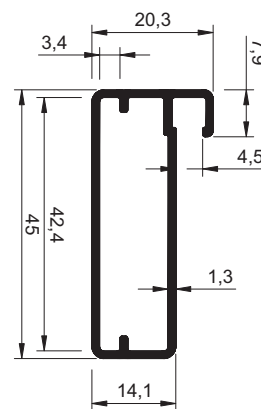

COMPATÍVEL · MONTAGEM  
**DES-877** **DES-204**  
**DES-950** **DES-897**  
**DES-282**

COMPATÍVEL · PUXADOR  
**DES-112** **DES-1252**  
**DES-203** **DES-1299**  
**DES-239** **DES-1324**

### DES-233

QUADRO VIDRO  
0,501 Kg/m  
22 x 45 x 6 mm

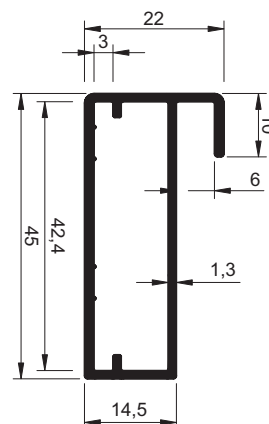

COMPATÍVEL · PUXADOR  
**DES-043** **DES-1278**  
**DES-112** **DES-1324**  
**DES-842**

A ALUMICONTE reserva-se o direito de fazer modificações em qualquer informação escrita neste catálogo sem aviso prévio. Os desenhos aqui contidos possuem medidas teóricas de massa e tolerâncias dimensionais de acordo com a ABNT NBR-8116, podendo haver variações dessas informações no produto final.

### DES-297

QUADRO VIDRO  
0,671 Kg/m  
22 x 65 x 6,2 mm

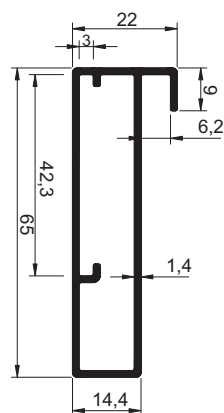

COMPATÍVEL · PUXADOR  
**DES-043** **DES-908**  
**DES-112** **DES-1278**  
**DES-842**

### DES-311

QUADRO VIDRO  
0,437 Kg/m  
20 x 45 x 4,8 mm

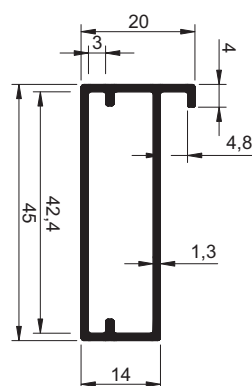

COMPATÍVEL · MONTAGEM  
**DES-370**

COMPATÍVEL · PUXADOR  
**DES-203**  
**DES-1299**  
**DES-1324**

### DES-318

QUADRO VIDRO  
0,427 Kg/m  
18 x 45 x 5 mm

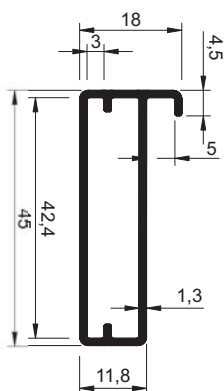

### DES-523

QUADRO VIDRO  
0,467 Kg/m  
20,3 x 45 x 4,5 mm

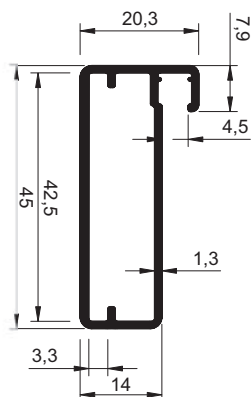

### DES-530

QUADRO VIDRO  
0,433 Kg/m  
18 x 45 x 4,6 mm

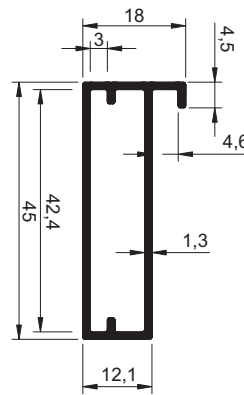

### DES-550

QUADRO VIDRO  
0,441 Kg/m  
18 x 45 x 4,5 mm

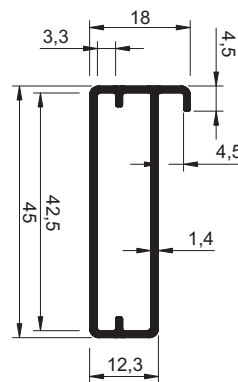

COMPATÍVEL · MONTAGEM  
**DES-551**

### DES-691

QUADRO VIDRO  
0,502 Kg/m  
20,2 x 45 x 4,3mm

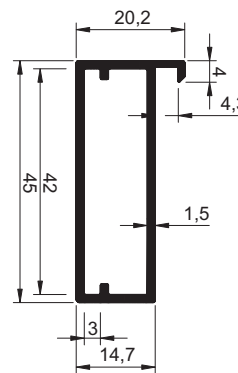

COMPATÍVEL · MONTAGEM  
**DES-690**

COMPATÍVEL · PUXADOR  
**DES-203**  
**DES-1299**  
**DES-1324**

### DES-875

QUADRO VIDRO  
0,443 Kg/m  
20,3 x 45 x 5 mm

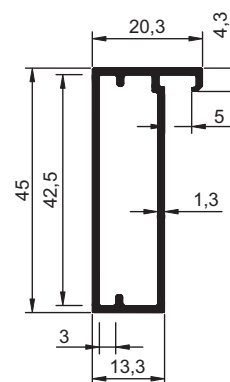

## DES-902

QUADRO VIDRO  
0,792 Kg/m  
22 x 70 x 6,2mm

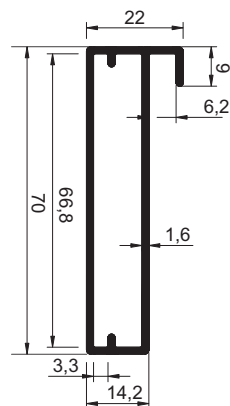

COMPATÍVEL · PUXADOR  
**DES-239**  
**DES-1299**  
**DES-1324**

## DES-929

QUADRO VIDRO  
0,488 Kg/m  
20,9 x 45 x 6,7 mm

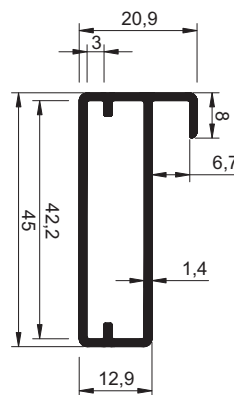

COMPATÍVEL · MONTAGEM  
**DES-930**

## DES-1060

QUADRO VIDRO  
0,477 Kg/m  
20,8 x 45,3 x 5,5 mm

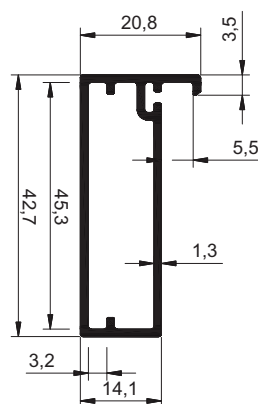

COMPATÍVEL · MONTAGEM  
**DES-1061**

## DES-1250

QUADRO VIDRO  
0,443 Kg/m  
18,6 x 45 x 4,5 mm

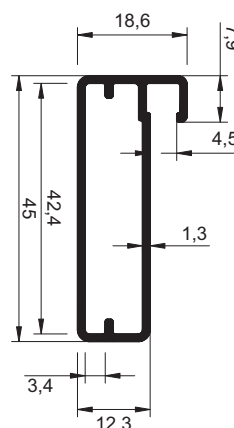

COMPATÍVEL · PUXADOR  
**DES-519**



### DES-1402

QUADRO VIDRO  
0,497 Kg/m  
20,3 x 45,2x 5,5 mm

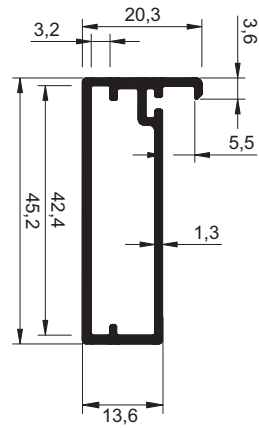

COMPATÍVEL · MONTAGEM  
**DES-1403**

### DES-1264

QUADRO VIDRO 45 x 20 mm  
0,440 Kg/m  
20 x 44,8 x 4,5 mm

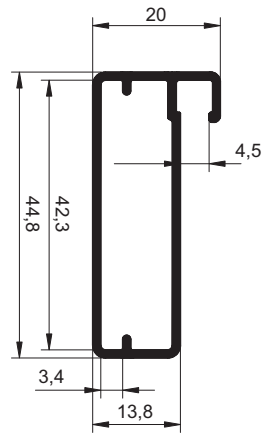

COMPATÍVEL · MONTAGEM  
**DES-1268**

COMPATÍVEL · PUXADOR  
**DES-239**

### DES-1326

QUADRO VIDRO  
0,682 Kg/m  
21,9 x 70 x 5,6mm

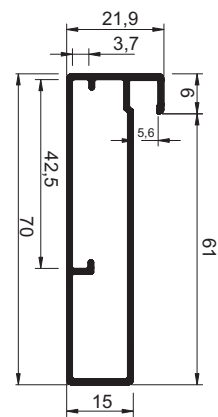

COMPATÍVEL · PUXADOR  
**DES-043**  
**DES-908**

### DES-1452

QUADRO VIDRO  
1,042 Kg/m  
22,3 x 70,8 x 6mm

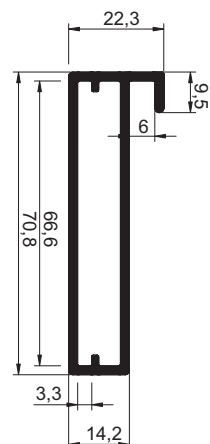

COMPATÍVEL · MONTAGEM  
**DES-1451**  
**DES-1453**

PRODUTO REFORÇADO  
IDEAL PARA  
PORTA DESLIZANTE

A ALUMICONTE reserva-se o direito de fazer modificações em qualquer informação escrita neste catálogo sem aviso prévio. Os desenhos aqui contidos possuem medidas teóricas de massa e tolerâncias dimensionais de acordo com a ABNT NBR-8116, podendo haver variações dessas informações no produto final.

### DES-1490

QUADRO VIDRO

0,546 Kg/m

25,4 x 26 x 4,8mm

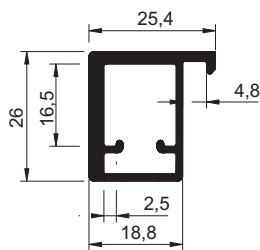

COMPATÍVEL · MONTAGEM

**DES-1489**

### DES-1328

QUADRO VIDRO

0,888 Kg/m

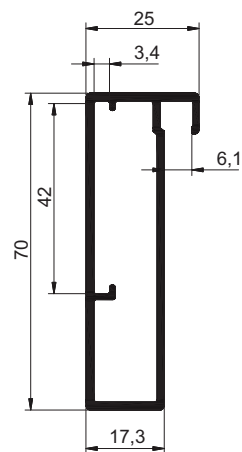

### DES-1609

QUADRO VIDRO

0,458 Kg/m

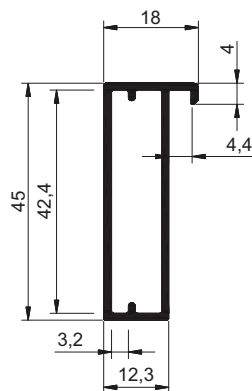

### DES-1612

QUADRO VIDRO

0,819 Kg/m

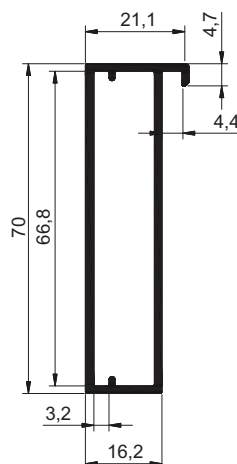

COMPATÍVEL · PUXADOR

**DES-043**

**DES-112**

**DES-833**

**DES-842**

### DES-060

QUADRO VIDRO  
0,422 Kg/m  
17 x 45 x 5,2 mm

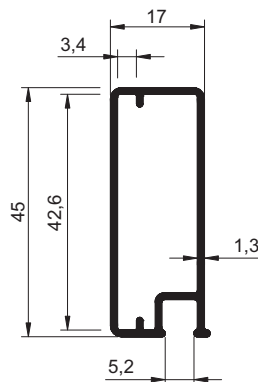

### DES-129

QUADRO VIDRO  
0,616 Kg/m  
16,5 x 49 x 5 mm

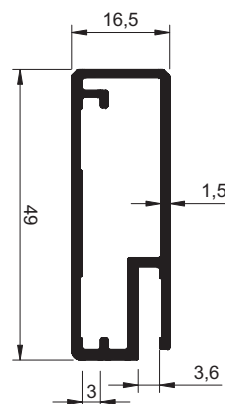

COMPATÍVEL · MONTAGEM  
**DES-130**

### DES-130

QUADRO VIDRO  
0,945 Kg/m  
20 x 75 x 3,6 mm

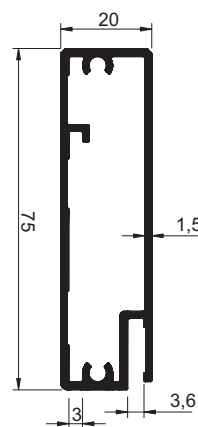

COMPATÍVEL · MONTAGEM  
**DES-129**

COMPATÍVEL · PUXADOR

**DES-203**   **DES-1299**  
**DES-239**   **DES-1324**  
**DES-1252**   **DES-1329**  
**DES-1280**

### DES-016

QUADRO VIDRO - 5,1mm  
0,483 Kg/m  
20 x 45,1 x 5,1 mm

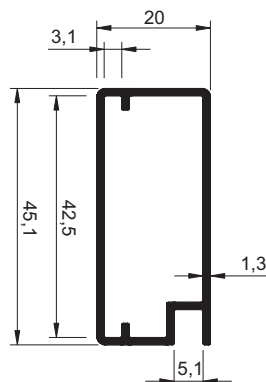

A ALUMICONTE reserva-se o direito de fazer modificações em qualquer informação escrita neste catálogo sem aviso prévio. Os desenhos aqui contidos possuem medidas teóricas de massa e tolerâncias dimensionais de acordo com a ABNT NBR-8116, podendo haver variações dessas informações no produto final.

### DES-300

QUADRO VIDRO  
0,437 Kg/m  
18 x 42 x 6 mm

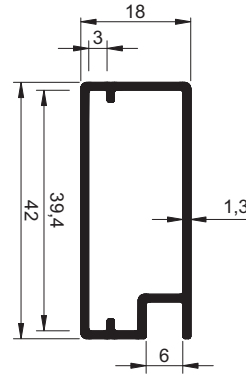

COMPATÍVEL · PUXADOR  
**DES-519**  
**DES-1614**

### DES-1291

QUADRO VIDRO  
0,576 Kg/m  
44,9 x 18 x 6mm

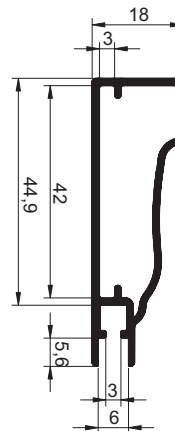

### DES-178

QUADRO VIDRO  
0,376 Kg/m  
15 x 35 x 5,2 mm

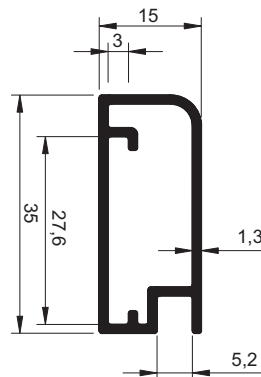

### DES-019

QUADRO VIDRO - 5,2mm  
0,459 Kg/m  
19,1 x 45 x 5,2 mm

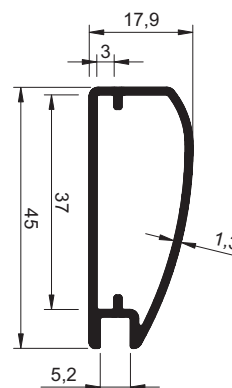

### DES-015

QUADRO VIDRO - 5,2mm

0,372 Kg/m

18,3 x 39 x 5,2 mm

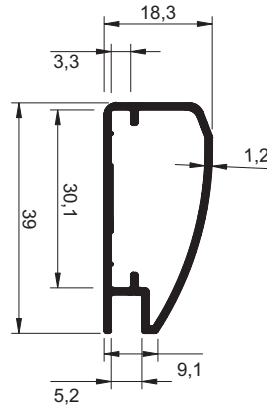

### DES-017

QUADRO VIDRO

0,495 Kg/m

20,4 x 50 x 5,1 mm

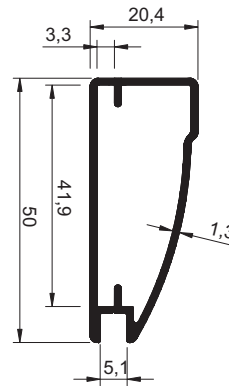

### DES-018

QUADRO VIDRO

0,475 Kg/m

20,5 x 45 x 5 mm

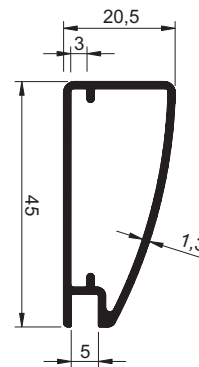

### DES-073

QUADRO PELE VIDRO

0,473 Kg/m

19 x 45 x 5 mm

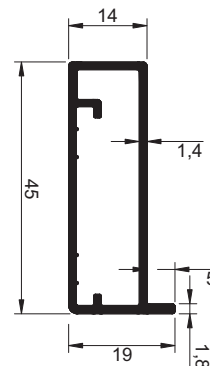

COMPATÍVEL · MONTAGEM

**DES-816**

COMPATÍVEL · PUXADOR

**DES-144**

**DES-145**

**DES-909**

A ALUMICONTE reserva-se o direito de fazer modificações em qualquer informação escrita neste catálogo sem aviso prévio. Os desenhos aqui contidos possuem medidas teóricas de massa e tolerâncias dimensionais de acordo com a ABNT NBR-8116, podendo haver variações dessas informações no produto final.

### DES-128

QUADRO PELE VIDRO

0,938 Kg/m

25 x 75 x 5 mm

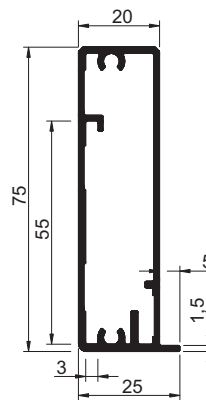

### DES-131

QUADRO PELE VIDRO

0,628 Kg/m

21,5 x 49 x 5 mm

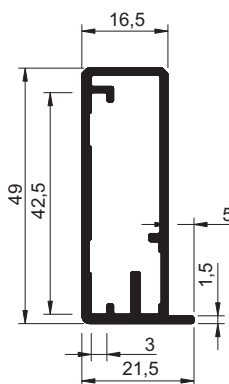

COMPATÍVEL · PUXADOR

**DES-112**

**DES-993**

**DES-1278**

**DES-1324**

### DES-147

QUADRO PELE VIDRO

0,382 Kg/m

18,8 x 45 x 4,8 mm

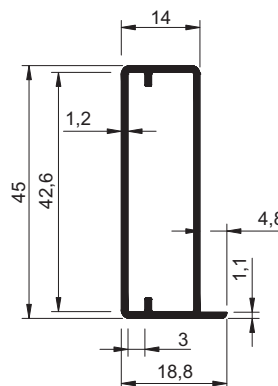

COMPATÍVEL · PUXADOR

**DES-144**

**DES-145**

### DES-226

QUADRO PELE VIDRO

0,591 Kg/m

22,5 x 53 x 5 mm

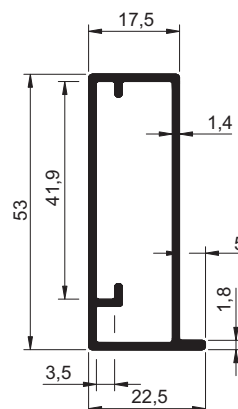

COMPATÍVEL · MONTAGEM

**DES-225**

**DES-227**

### DES-951

QUADRO PELE VIDRO

0,748 Kg/m

19,2 x 45 x 5 mm

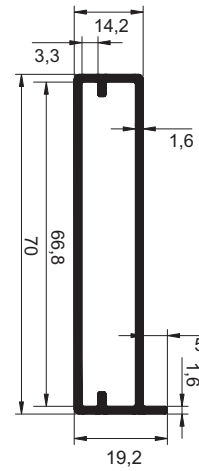

COMPATÍVEL · MONTAGEM

**DES-952**

COMPATÍVEL · PUXADOR

**DES-145**

### DES-953

QUADRO PELE VIDRO

0,459 Kg/m

16,7 x 45 x 2,7 mm

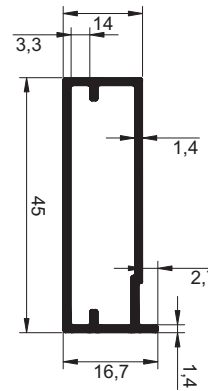

COMPATÍVEL · MONTAGEM

**DES-816**

### DES-1073

QUADRO PELE VIDRO

0,481 Kg/m

19 x 45 x 5 mm

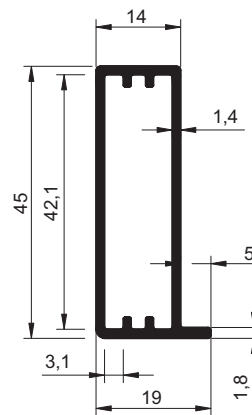

COMPATÍVEL · MONTAGEM

**DES-1074**

**DES-1075**

### DES-1279

QUADRO PELE DE VIDRO

0,444 Kg/m

17,8 x 45 x 3,8 mm

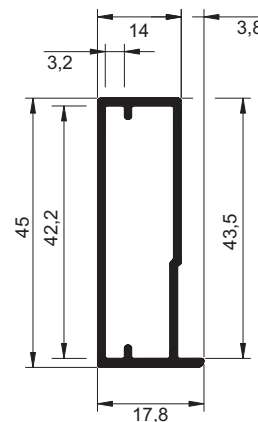

COMPATÍVEL · MONTAGEM

**DES-816**

A ALUMICONTE reserva-se o direito de fazer modificações em qualquer informação escrita neste catálogo sem aviso prévio. Os desenhos aqui contidos possuem medidas teóricas de massa e tolerâncias dimensionais de acordo com a ABNT NBR-8116, podendo haver variações dessas informações no produto final.

## DES-1451

QUADRO PELE DE VIDRO  
0,983 Kg/m  
19,2 x 70,8 x 5mm



PRODUTO REFORÇADO  
IDEAL PARA  
PORTA DESLIZANTE

COMPATÍVEL · MONTAGEM  
**DES-1452**  
**DES-1453**

## DES-1300

QUADRO PELE DE VIDRO  
0,426 Kg/m  
48,2 x 20,4 x 4,8 mm

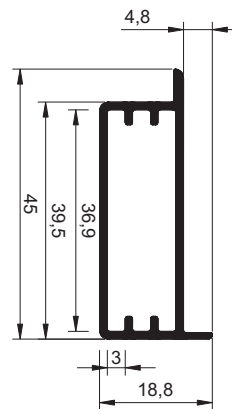

## DES-1301

QUADRO PELE DE VIDRO  
0,508 Kg/m  
48,2 x 20,4 x 4,8 mm

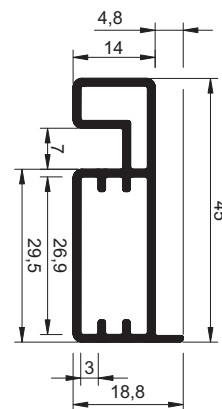

## DES-1414

QUADRO PELE DE VIDRO  
0,506 Kg/m  
48,2 x 20,4 x 4,8 mm

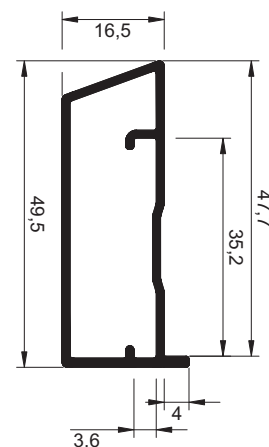



## DES-1226

QUADRO VIDRO | FIXAÇÃO NÃO APARENTE

0,615 Kg/m

22,5 x 53 x 5mm

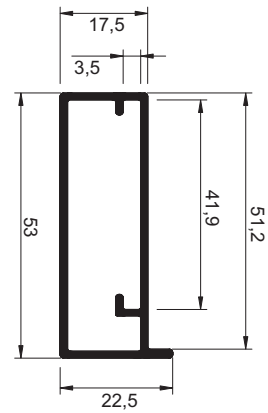
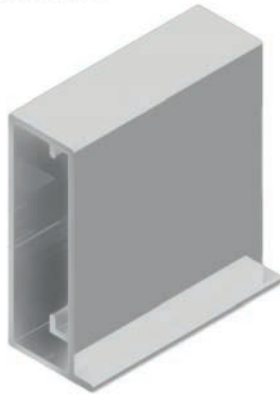

COMPATÍVEL · MONTAGEM

**DES-1225**

**DES-1227**

**DES-1228**

## DES-1321

QUADRO PELE DE VIDRO

0,890 Kg/m

21,7 x 70mm

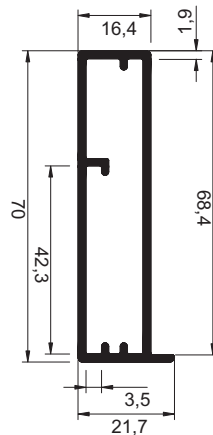

## DES-1492

QUADRO PELE VIDRO

0,514 Kg/m

26 x 22,6 x 3,8mm

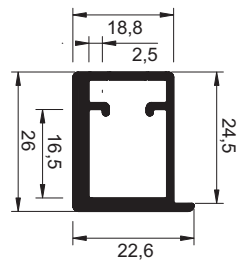

COMPATÍVEL · MONTAGEM

**DES-1491**

## DES-1407

QUADRO PELE VIDRO

0,293 Kg/m

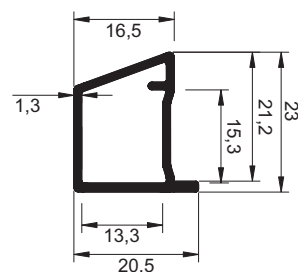

COMPATÍVEL · MONTAGEM

**DES-1408**

## DES-912

REQUADRO VIDRO  
0,552 Kg/m

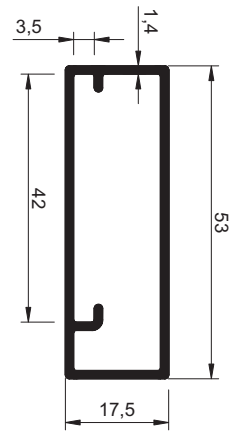

COMPATÍVEL · PUXADOR  
**DES-1614**

## DES-1093

REQUADRO VIDRO  
0,536 Kg/m  
16 x 45mm

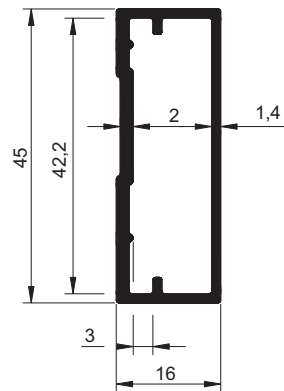

COMPATÍVEL · MONTAGEM  
**DES-1094**

## DES-1042

QUADRO VIDRO  
0,335 Kg/m  
45 x 17 mm

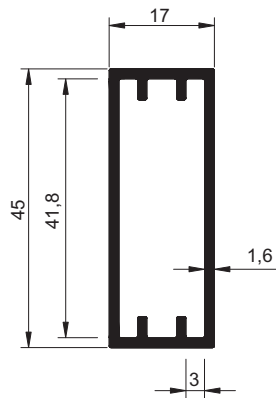

COMPATÍVEL · MONTAGEM  
**DES-1043**

# COM PUXADOR

QUADRO DE VIDRO COM PUXADOR

## DES-204

QUADRO VIDRO C/ PUXADOR  
0,855 Kg/m  
20,3 x 78,5 x 4,5mm

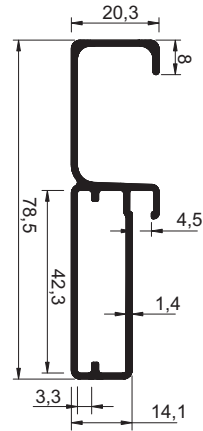

COMPATÍVEL · MONTAGEM  
**DES-198**

## DES-551

QUADRO VIDRO C/ PUXADOR  
0,727 Kg/m  
18 x 80 x 4,5mm

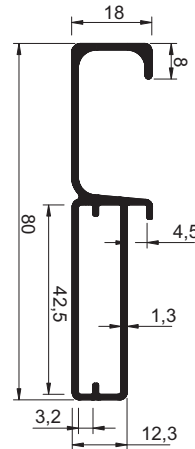

COMPATÍVEL · MONTAGEM  
**DES-550**

## DES-370

QUADRO VIDRO C/ PUXADOR  
0,701 Kg/m  
20 x 78,7 x 4,7mm

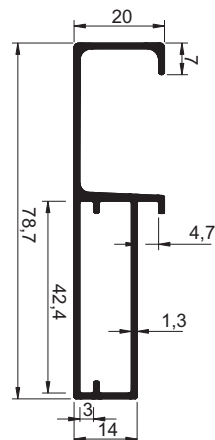

COMPATÍVEL · MONTAGEM  
**DES-311**

## DES-730

QUADRO VIDRO C/ PUXADOR  
0,831 Kg/m  
21,1 x 80 x 4,6mm

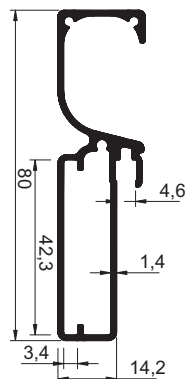
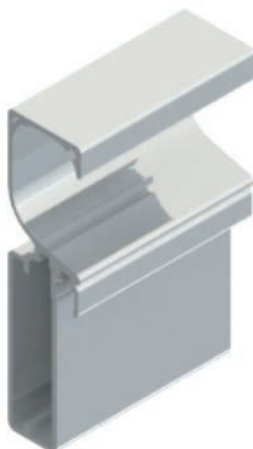

**PONTEIRA COMPATÍVEL**  
PRETO | BRANCO | CROMO  
BRONZE | FOSCO | INOX



COMPATÍVEL · MONTAGEM  
**DES-198**

A ALUMICONTE reserva-se o direito de fazer modificações em qualquer informação escrita neste catálogo sem aviso prévio. Os desenhos aqui contidos possuem medidas teóricas de massa e tolerâncias dimensionais de acordo com a ABNT NBR-8116, podendo haver variações dessas informações no produto final.

## DES-282

QUADRO VIDRO C/ PUXADOR  
0,921 Kg/m

20,2 x 80,1 x 4,5mm

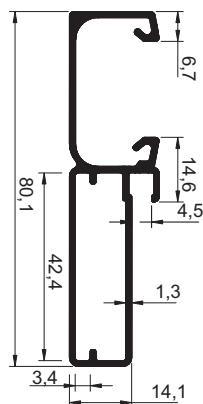

PONTEIRA COMPATÍVEL  
PRETO | BRANCO | CROMO  
BRONZE | FOSCO | INOX



COMPATÍVEL · MONTAGEM  
**DES-198**

## DES-690

QUADRO VIDRO C/ PUXADOR  
0,808 Kg/m

20,2 x 78,8 x 4,3mm

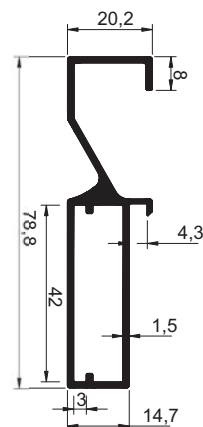
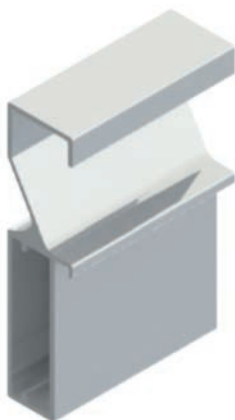

COMPATÍVEL · MONTAGEM  
**DES-691**

## DES-1403

QUADRO PELE VIDRO C/ PUXADOR  
0,772 Kg/m

20,3 x 79 x 5,5mm

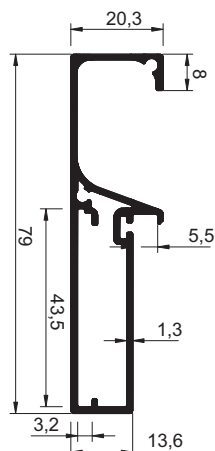

PONTEIRA COMPATÍVEL  
PRETO | BRANCO | CROMO  
BRONZE | FOSCO | INOX



COMPATÍVEL · MONTAGEM  
**DES-1402**

## DES-1061

QUADRO PELE VIDRO C/ PUXADOR  
0,847 Kg/m

21 x 80,3 x 5,5mm

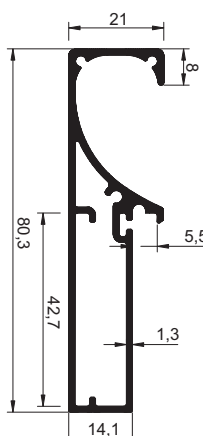
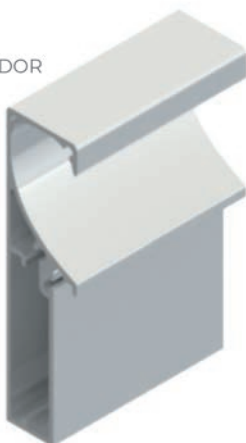

PONTEIRA COMPATÍVEL  
PRETO | BRANCO | CROMO  
BRONZE | FOSCO | INOX



COMPATÍVEL · MONTAGEM  
**DES-1060**

### DES-930

QUADRO VIDRO C/ PUXADOR

0,886 Kg/m  
20,5 x 77,6 x 6,7mm

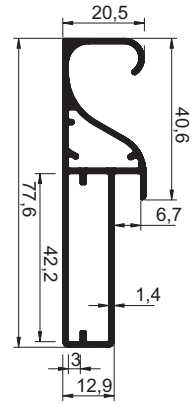

COMPATÍVEL · MONTAGEM  
**DES-929**

### DES-950

QUADRO VIDRO C/ PUXADOR

0,801 Kg/m  
20,2 x 78,8 x 4,5mm

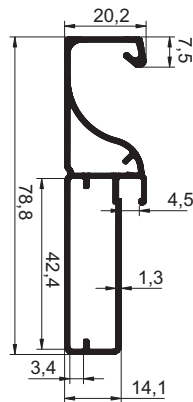

**PONTEIRA COMPATÍVEL**  
PRETO | BRANCO | CROMO  
BRONZE | FOSCO | INOX



COMPATÍVEL · MONTAGEM  
**DES-198**

### DES-1014

QUADRO PELE VIDRO C/ PUXADOR

0,923 Kg/m  
20,2 x 82,1 x 5,2mm

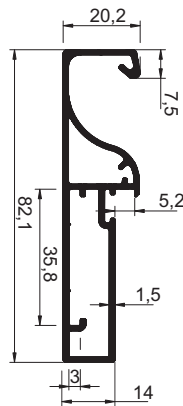

COMPATÍVEL · MONTAGEM  
**DES-854**

### DES-1268

QUADRO VIDRO C/ PUXADOR

0,754 Kg/m  
20,3 x 78,6 x 4,5mm

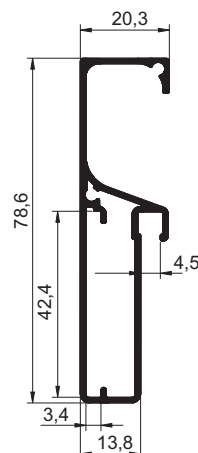

COMPATÍVEL · MONTAGEM  
**DES-1264**

A ALUMICONTE reserva-se o direito de fazer modificações em qualquer informação escrita neste catálogo sem aviso prévio. Os desenhos aqui contidos possuem medidas teóricas de massa e tolerâncias dimensionais de acordo com a ABNT NBR-8116, podendo haver variações dessas informações no produto final.

### DES-1610

QUADRO VIDRO C/ PUXADOR  
0,741 Kg/m

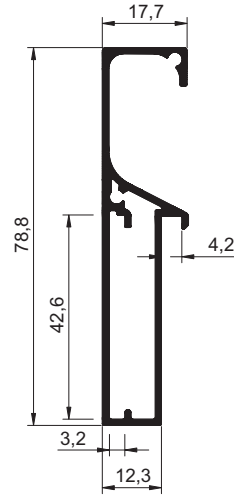

### DES-1419

QUADRO VIDRO C/ PUXADOR  
0,809 Kg/m

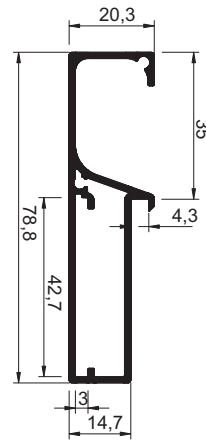

### DES-076

QUADRO VIDRO C/ PUXADOR  
0,578 Kg/m  
34,5 x 45 x 4,7mm

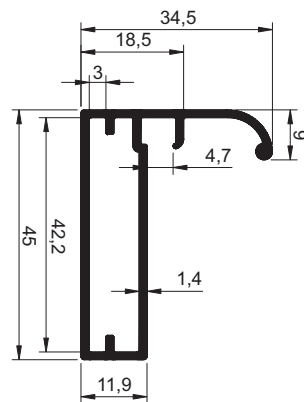

COMPATÍVEL · MONTAGEM  
**DES-077**

### DES-158

QUADRO VIDRO C/ PUXADOR  
0,563 Kg/m  
36,8 x 45 x 5,2mm

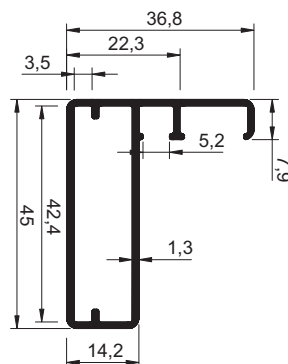

COMPATÍVEL · MONTAGEM  
**DES-001**

### DES-877

QUADRO VIDRO C/ PUXADOR  
 0,524 Kg/m  
 33,6 x 45 x 4,5mm

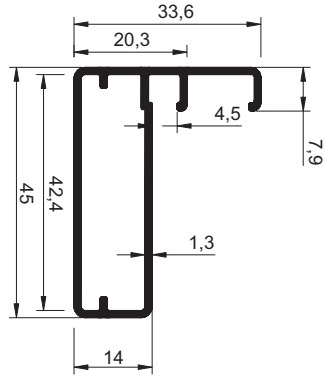

COMPATÍVEL · MONTAGEM  
**DES-198**

### DES-692

QUADRO VIDRO C/ PUXADOR  
 0,619 Kg/m  
 33,2 x 45 x 4,3mm

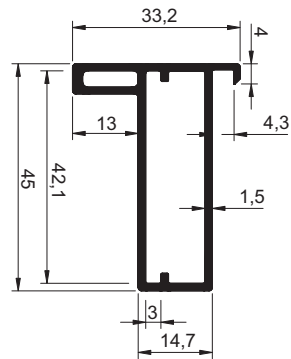

COMPATÍVEL · MONTAGEM  
**DES-691**

### DES-1489

REQUADRO VIDRO C/ PUXADOR  
 0,684 Kg/m  
 26 x 40 x 4,8mm

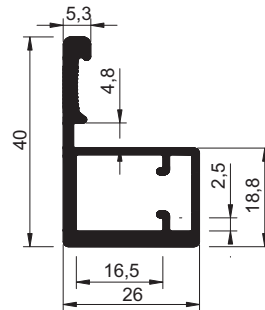

COMPATÍVEL · MONTAGEM  
**DES-1490**

### DES-313

QUADRO VIDRO C/ PUXADOR  
 0,574 Kg/m

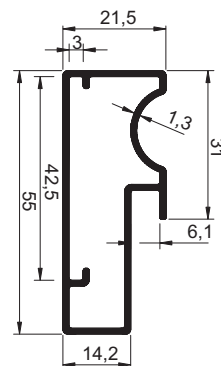

A ALUMICONTE reserva-se o direito de fazer modificações em qualquer informação escrita neste catálogo sem aviso prévio. Os desenhos aqui contidos possuem medidas teóricas de massa e tolerâncias dimensionais de acordo com a ABNT NBR-8116, podendo haver variações dessas informações no produto final.

### DES-320

QUADRO VIDRO C/ PUXADOR

0,566 Kg/m

21,5 x 55 x 6,1mm

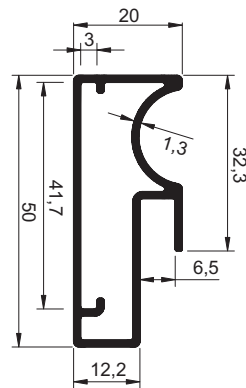

### DES-897

QUADRO VIDRO C/ PUXADOR

0,681 Kg/m

20,3 x 66 x 4,5mm

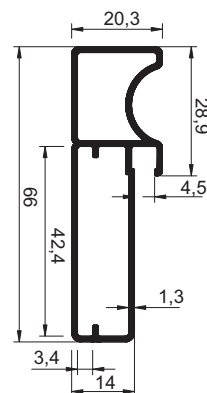

COMPATÍVEL · MONTAGEM

DES-198

### DES-012

QUADRO VIDRO C/ PUXADOR

0,558 Kg/m

20 x 44,8 x 5,2mm

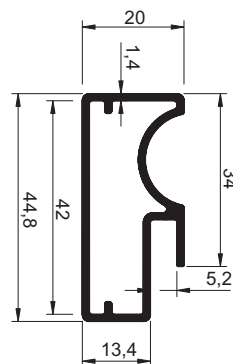

### DES-940

QUADRO VIDRO C/ PUXADOR

0,857 Kg/m

22 x 70 x 6,2mm

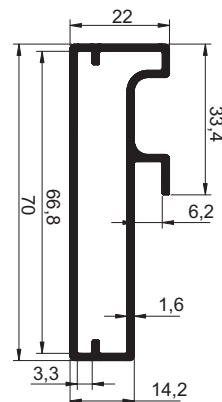



### DES-1265

QUADRO VIDRO C/ PUXADOR  
 0,505 Kg/m  
 20 x 44,8 x 4,5mm

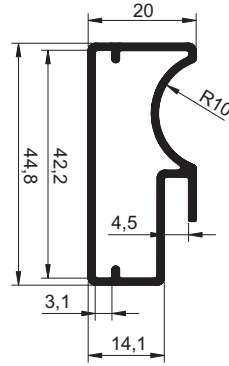
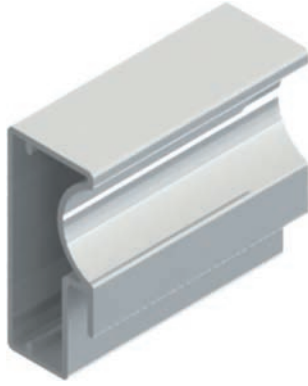

### DES-011

QUADRO VIDRO C/ PUXADOR  
 0,668 Kg/m  
 22,5 x 60 x 6,2mm

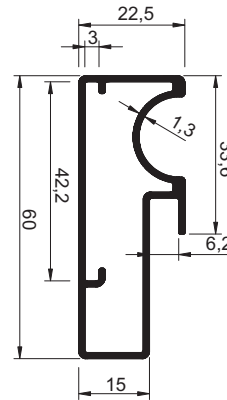

COMPATÍVEL · MONTAGEM

DES-168  
 DES-868

### DES-1012

QUADRO VIDRO C/ PUXADOR  
 0,500 Kg/m  
 20,2 x 45 x 5mm

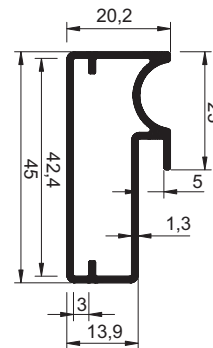

### DES-026

QUADRO VIDRO C/ PUXADOR  
 0,453 Kg/m  
 21 x 31,4 x 6mm

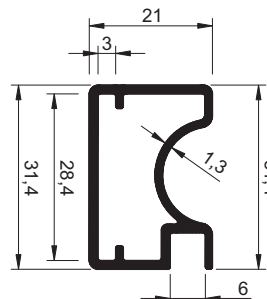

A ALUMICONTE reserva-se o direito de fazer modificações em qualquer informação escrita neste catálogo sem aviso prévio. Os desenhos aqui contidos possuem medidas teóricas de massa e tolerâncias dimensionais de acordo com a ABNT NBR-8116, podendo haver variações dessas informações no produto final.

### DES-187

QUADRO VIDRO C/ PUXADOR

0,635 Kg/m

20 x 60 x 4mm

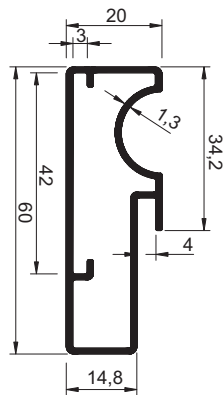

### DES-078

QUADRO VIDRO C/ PUXADOR

0,520 Kg/m

22,3 x 45 x 6,5mm

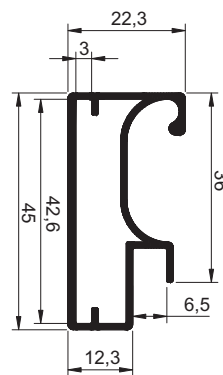

### DES-193

QUADRO VIDRO C/ PUXADOR

0,578 Kg/m

20 x 60 x 6mm

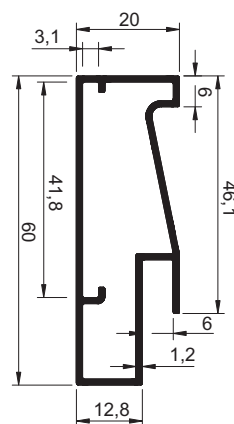

### DES-279

QUADRO VIDRO C/ PUXADOR

0,523 Kg/m

22 x 45 x 6,2mm

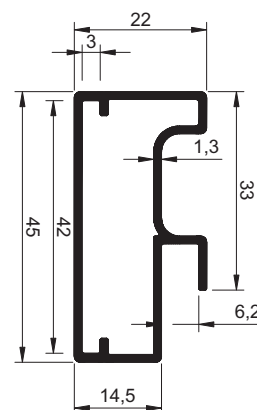

### DES-301

QUADRO VIDRO C/ PUXADOR  
 0,401 Kg/m  
 20 x 31,8 x 6mm

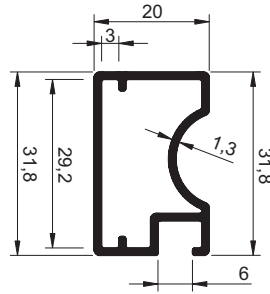

### DES-362

QUADRO VIDRO C/ PUXADOR  
 0,400 Kg/m  
 20 x 35 x 6,1mm

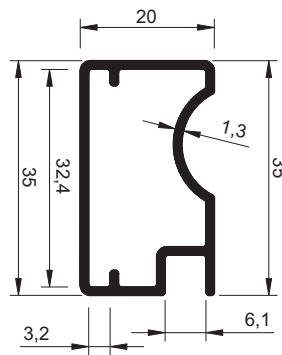

### DES-1043

REQUADRO VIDRO C/ PUXADOR  
 0,939 Kg/m  
 17 x 80mm

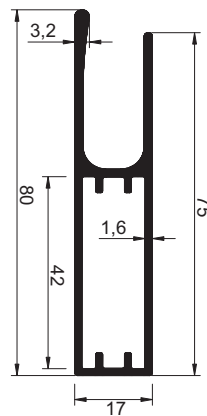

COMPATÍVEL · MONTAGEM  
**DES-1042**

### DES-1094

QUADRO PELE VIDRO C/ PUXADOR  
 0,879 Kg/m  
 16 x 80mm

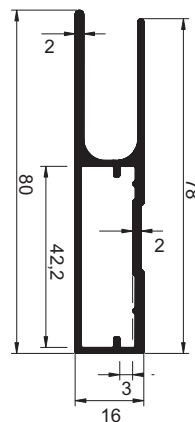

COMPATÍVEL · MONTAGEM  
**DES-1093**

A ALUMICONTE reserva-se o direito de fazer modificações em qualquer informação escrita neste catálogo sem aviso prévio. Os desenhos aqui contidos possuem medidas teóricas de massa e tolerâncias dimensionais de acordo com a ABNT NBR-8116, podendo haver variações dessas informações no produto final.

## DES-1225

QUADRO VIDRO C/ PUXADOR  
SEM FIXAÇÃO APARENTE

0,727 Kg/m  
22,5 x 68 x 5mm

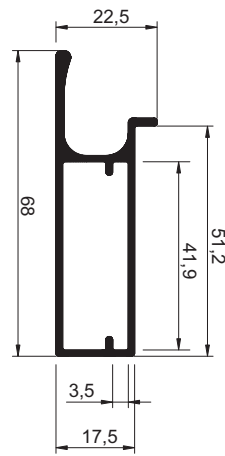

PONTEIRA COMPATÍVEL  
BRONZE | FOSCO | INOX

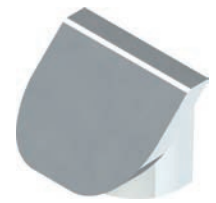

COMPATÍVEL · MONTAGEM  
**DES-1226**  
**DES-1227**

## DES-225

QUADRO PELE VIDRO C/ PUXADOR  
0,698 Kg/m  
22,5x 68 x 5mm

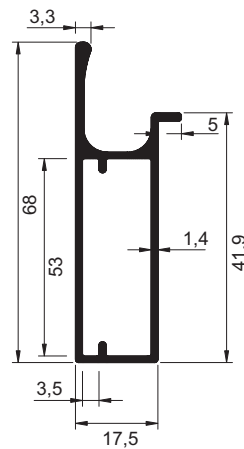
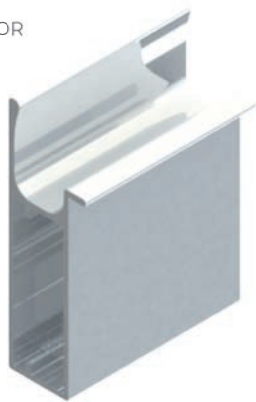

PONTEIRA COMPATÍVEL  
BRONZE | FOSCO | INOX



COMPATÍVEL · MONTAGEM  
**DES-226**  
**DES-227**

## DES-227

QUADRO PELE VIDRO C/ PUXADOR  
0,608 Kg/m  
22,5 x 53 x 5mm

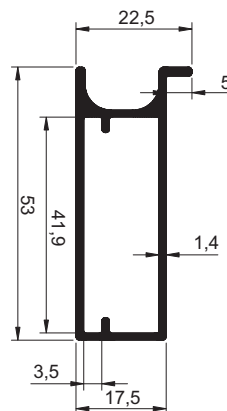

PONTEIRA COMPATÍVEL  
BRONZE | FOSCO | INOX



COMPATÍVEL · MONTAGEM  
**DES-225**  
**DES-226**

## DES-1227

QUADRO VIDRO C/ PUXADOR  
FIXAÇÃO NÃO APARENTE  
0,633 Kg/m  
22,5 x 53 x 5mm

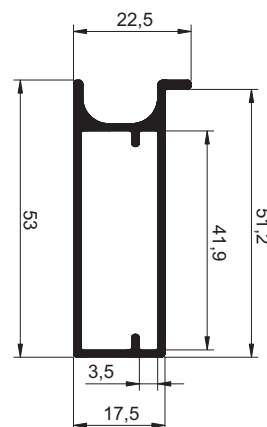

PONTEIRA COMPATÍVEL  
BRONZE | FOSCO | INOX



COMPATÍVEL · MONTAGEM  
**DES-1225**  
**DES-1226**  
**DES-1228**

### DES-1228

QUADRO VIDRO C/ PUXADOR  
0,862 Kg/m  
22,5 x 80 x 5mm

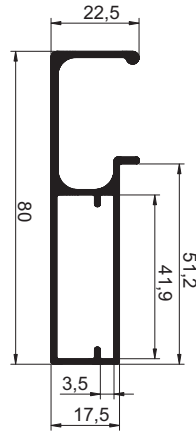

PONTEIRA COMPATÍVEL  
BRONZE | FOSCO | INOX

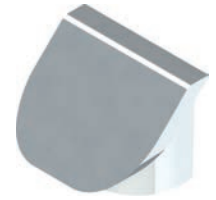

COMPATÍVEL · MONTAGEM  
**DES-1226**  
**DES-1227**

### DES-1271

QUADRO VIDRO C/ PUXADOR  
0,862 Kg/m  
22,5 x 80 x 5mm

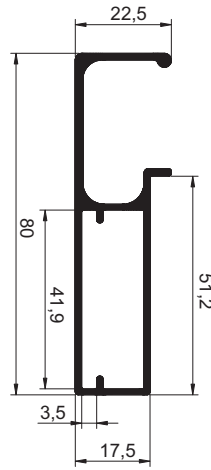

PONTEIRA COMPATÍVEL  
BRONZE | FOSCO | INOX

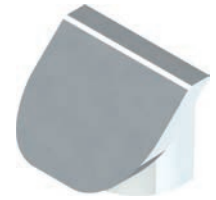

COMPATÍVEL · MONTAGEM  
**DES-226**  
**DES-225**  
**DES-227**

### DES-1074

QUADRO PELE VIDRO C/ PUXADOR  
0,628 Kg/m  
35 x 45 x 5mm

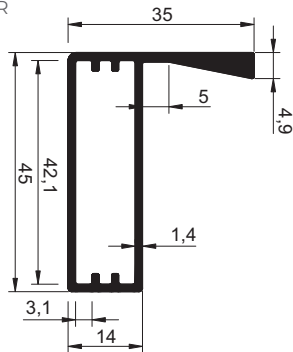

COMPATÍVEL · MONTAGEM  
**DES-1073 | DES-1075**

### DES-1491

QUADRO VIDRO C/ PUXADOR  
0,659 Kg/m  
26 x 40mm

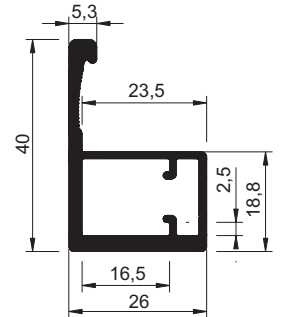

COMPATÍVEL · MONTAGEM  
**DES-1492**

### DES-1408

QUADRO VIDRO C/ PUXADOR  
0,704 Kg/m

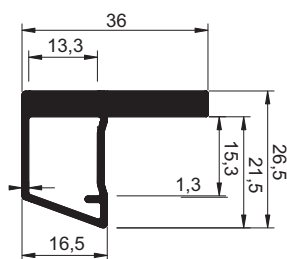

COMPATÍVEL · MONTAGEM  
**DES-1407**

### DES-1697

QUADRO VIDRO C/ PUXADOR  
0,599 Kg/m

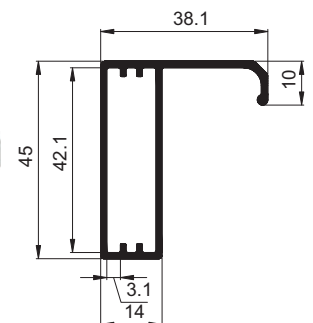

A ALUMICONTE reserva-se o direito de fazer modificações em qualquer informação escrita neste catálogo sem aviso prévio. Os desenhos aqui contidos possuem medidas teóricas de massa e tolerâncias dimensionais de acordo com a ABNT NBR-8116, podendo haver variações dessas informações no produto final.

# TRAVESSA

## DES-1453

TRAVESSA QUADRO VIDRO

0,476 Kg/m

27 x 19,2 x 5mm

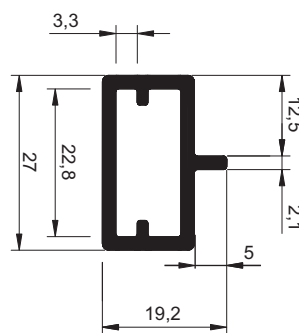

COMPATÍVEL · MONTAGEM

**DES-1451**

**DES-1452**

## DES-168

TRAVESSA QUADRO VIDRO

0,482 Kg/m

22,5 x 20 x 6,1mm

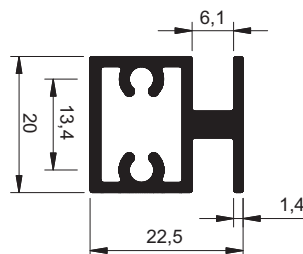
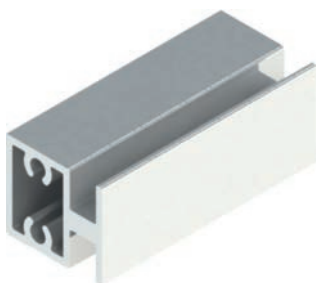

COMPATÍVEL · MONTAGEM

**DES-011**

## DES-247

TRAVESSA QUADRO VIDRO

0,262 Kg/m

18,5 x 20 x 6 mm

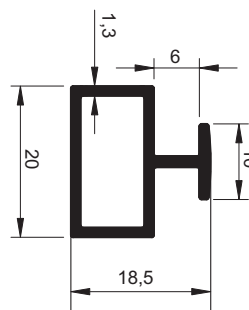

## DES-952

TRAVESSA QUADRO VIDRO

0,317 Kg/m

13,9 x 27 x 5 mm

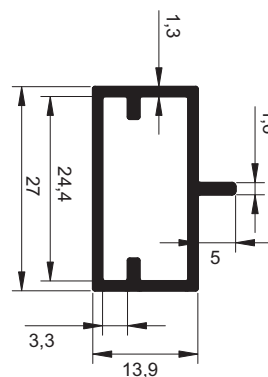

COMPATÍVEL · MONTAGEM

**DES-951**

### DES-1017

TRAVESSA QUADRO VIDRO

0,330 Kg/m

20 x 22,1 x 5,2 mm

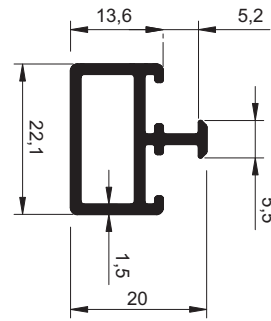

COMPATÍVEL · MONTAGEM

**DES-1403**

### DES-1075

TRAVESSA INTERMEDIÁRIA

0,469 Kg/m

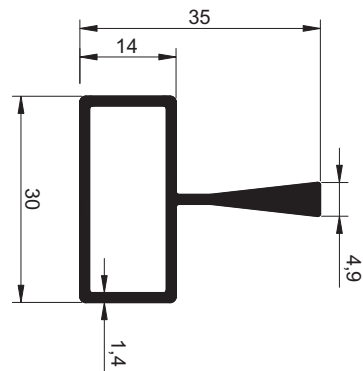
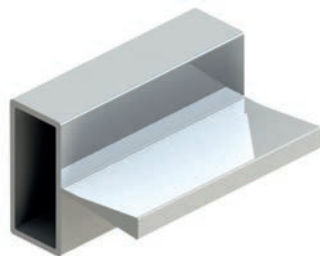

### DES-1297

TRAVESSA OCULTA

0,500 Kg/m

40 x 23,6 mm

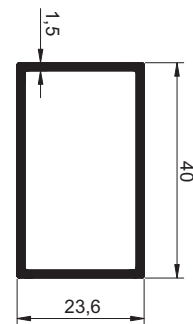
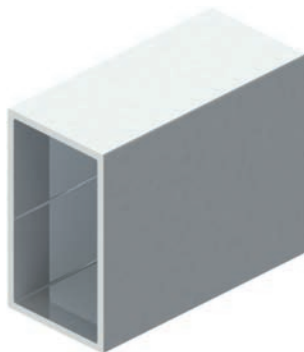

COMPATÍVEL · MONTAGEM

**DES-600**

### DES-077

TRAVESSA QUADRO VIDRO

0,168 Kg/m

11,9 x 11,9 mm

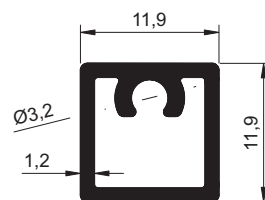

COMPATÍVEL · MONTAGEM

**DES-076**

A ALUMICONTE reserva-se o direito de fazer modificações em qualquer informação escrita neste catálogo sem aviso prévio. Os desenhos aqui contidos possuem medidas teóricas de massa e tolerâncias dimensionais de acordo com a ABNT NBR-8116, podendo haver variações dessas informações no produto final.

### DES-856

TRAVESSA QUADRO VIDRO

0,203 Kg/m

14 x 16,8mm

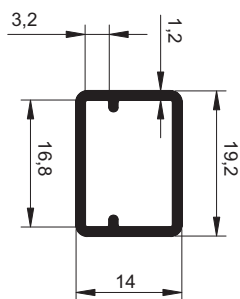

### DES-1016

TRAVESSA QUADRO VIDRO

0,232 Kg/m

13,6 x 20mm

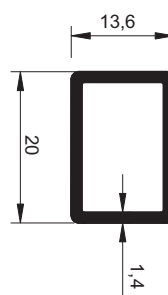

COMPATÍVEL · MONTAGEM

**DES-1403**

### DES-868

QUADRO VIDRO DUPLO

0,533 Kg/m

22,5 x 41 x 7,4mm

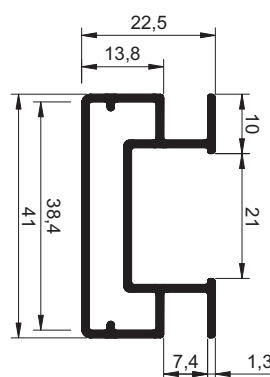

### DES-1044

REQUADRO VIDRO C/ PUXADOR

0,732 Kg/m

48 x 18mm

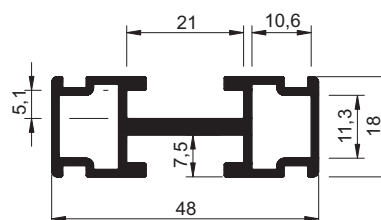





# PERFIL PARA TRILHO DE CORRER

Perfis responsáveis por dar base e auxiliar no direcionamento e funcionamento eficiente de portas de correr.

## ACABAMENTOS & CORES

**Natural**

**Anodizado**

Fosco | Bronze 1001 | 1002 | 1003 | Preto

**Jateado e Anodizado**

Fosco | Bronze 1001 | 1002 | 1003 | Preto

**Escovado e Anodizado**

Inox | Preto

**Pintura Eletrostática**



### DES-036

TRILHO SUPERIOR SIMPLES  
0,643 Kg/m

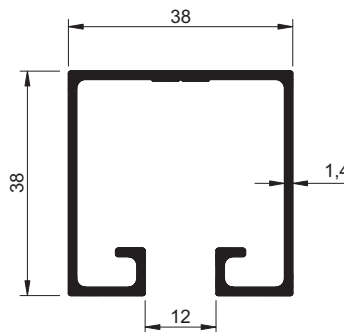
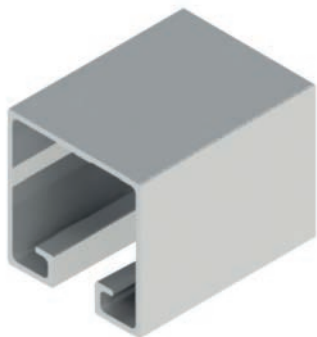

### DES-037

TRILHO SUPERIOR SIMPLES (ROLDANA CÔNCAVA)  
0,558 Kg/m

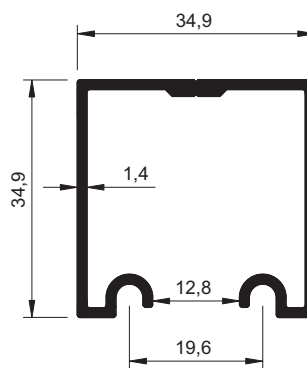
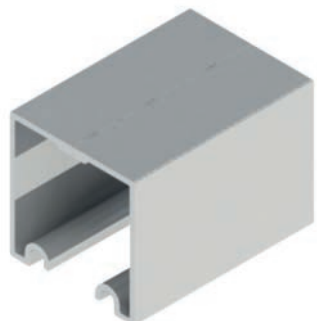

### DES-044

TRILHO SUPERIOR SIMPLES (ROLDANA CÔNCAVA)  
0,494 Kg/m

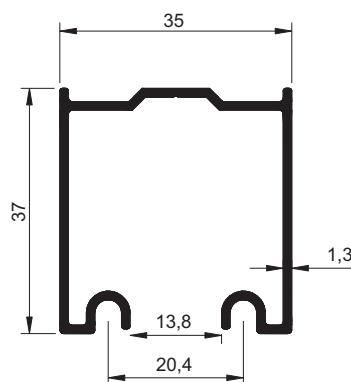

### DES-200

TRILHO SUPERIOR SIMPLES (ROLDANA CÔNCAVA)  
0,577 Kg/m

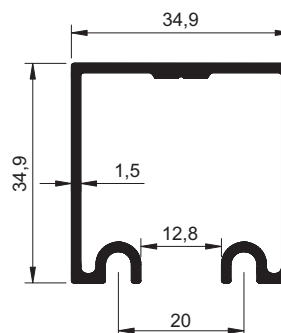
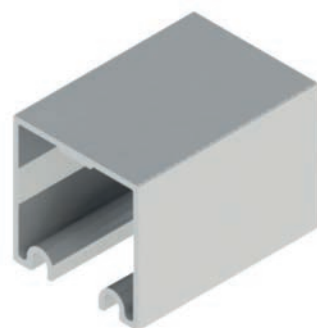

A ALUMICONTE reserva-se o direito de fazer modificações em qualquer informação escrita neste catálogo sem aviso prévio. Os desenhos aqui contidos possuem medidas teóricas de massa e tolerâncias dimensionais de acordo com a ABNT NBR-8116, podendo haver variações dessas informações no produto final.

### DES-261

TRILHO SUPERIOR SIMPLES C/ ENCAIXE BANDEIRA  
0,623 Kg/m

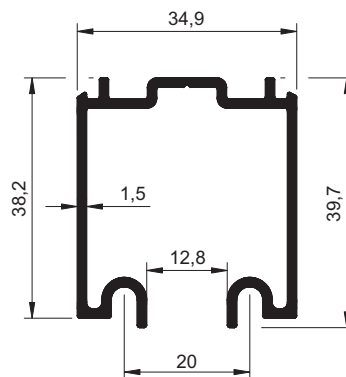
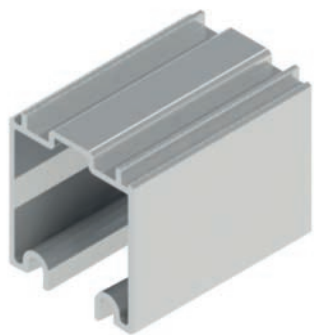

COMPATÍVEL · MONTAGEM  
**DES-262**

### DES-262

CAPA TRILHO SUPERIOR (DES-261 -DES-273)  
0,306 Kg/m

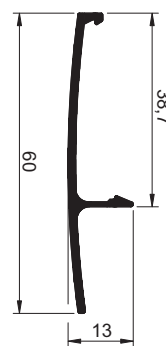
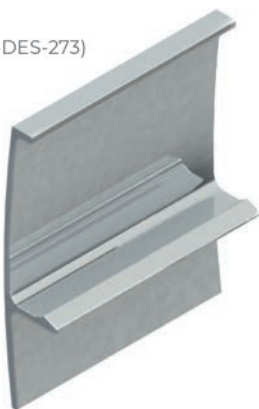

COMPATÍVEL · MONTAGEM  
**DES-261**  
**DES-273**

### DES-167

TRILHO SUPERIOR SIMPLES (ROLDANA CONVEXA)  
0,431 Kg/m

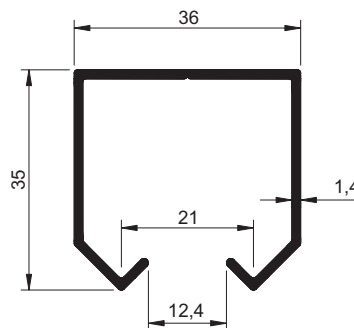
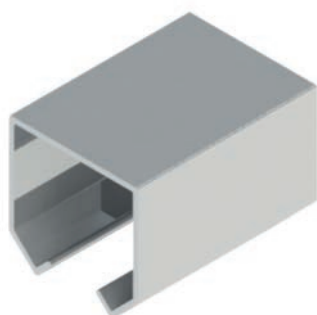

### DES-039

TRILHO SUPERIOR SIMPLES (ROLDANA CONVEXA)  
0,432 Kg/m

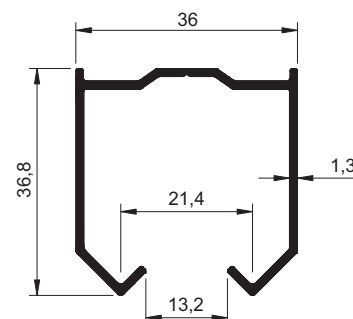
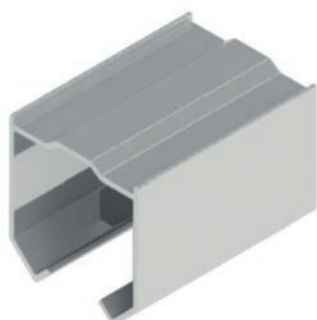

### DES-886

TRILHO SUPERIOR SIMPLES (ROLDANA CONVEXA)

0,572 Kg/m

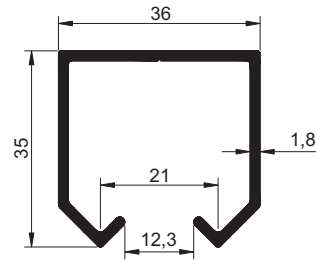
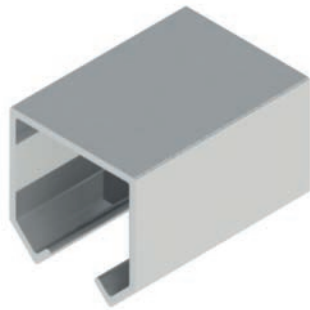

### DES-595

TRILHO SUPERIOR SIMPLES C/ ENCAIXE AFASTADOR

0,956 Kg/m

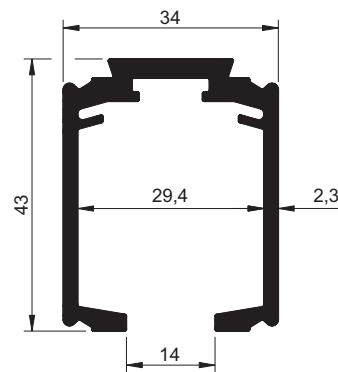

COMPATÍVEL · MONTAGEM

DES-593

DES-594

DES-1698

### DES-593

FIXADOR TRILHO SUPERIOR

0,559 Kg/m

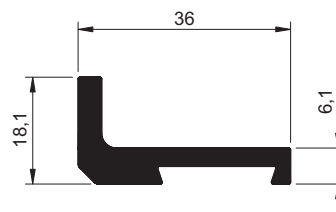
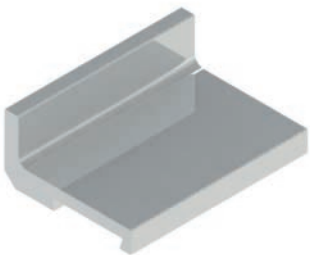

COMPATÍVEL · MONTAGEM

DES-595

### DES-594

CAPA FRONTAL TRILHO SUPERIOR

0,489 Kg/m

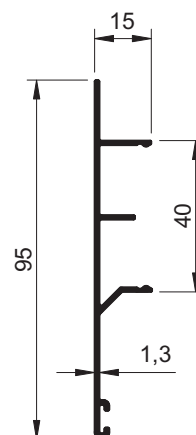

COMPATÍVEL · MONTAGEM

DES-595

A ALUMICONTE reserva-se o direito de fazer modificações em qualquer informação escrita neste catálogo sem aviso prévio. Os desenhos aqui contidos possuem medidas teóricas de massa e tolerâncias dimensionais de acordo com a ABNT NBR-8116, podendo haver variações dessas informações no produto final.

## DES-1698

CAPA FRONTAL TRILHO  
0,389 Kg/m

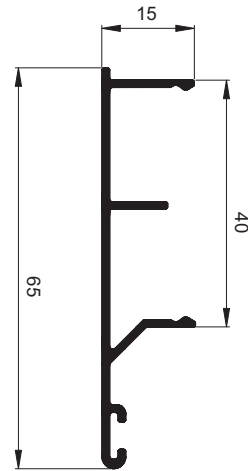
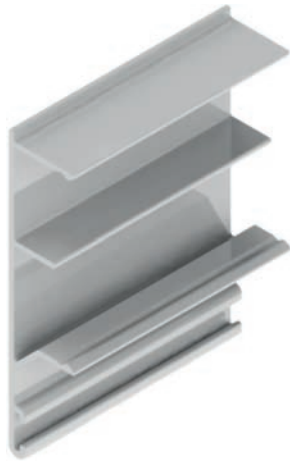

COMPATÍVEL · MONTAGEM  
DES-595

## DES-035

TRILHO SUPERIOR SIMPLES  
0,387 Kg/m

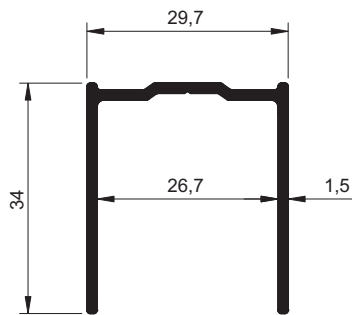

## DES-944

TRILHO SUPERIOR SIMPLES  
0,317 Kg/m

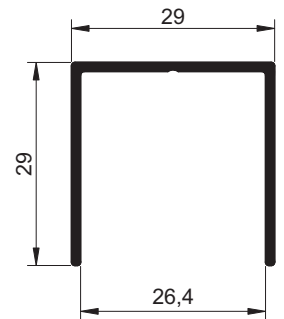

## DES-380

TRILHO SUPERIOR SIMPLES C/ ENCAIXE FREIO  
0,546 Kg/m

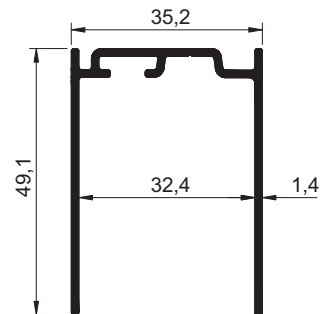

## DES-1433

TRILHO SUPERIOR SIMPLES  
0,570 Kg/m

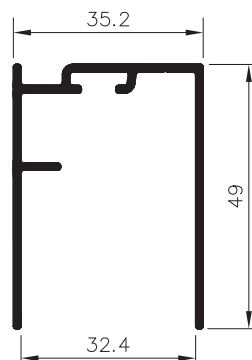

### DES-980

TRILHO SUPERIOR SIMPLES  
0,301 Kg/m

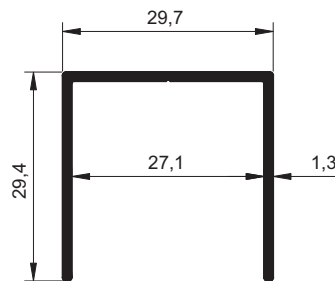
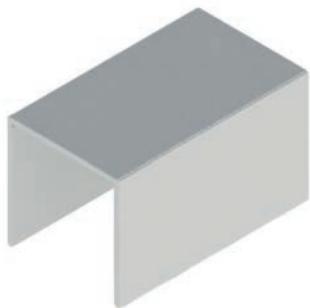

### DES-992

TRILHO SUPERIOR SIMPLES  
0,249 Kg/m

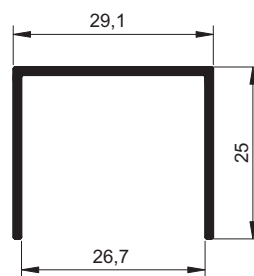
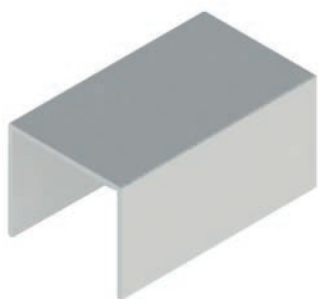

### DES-273

SUPERIOR SIMPLES C/ ENCAIXE BANDEIRA  
1,103 Kg/m

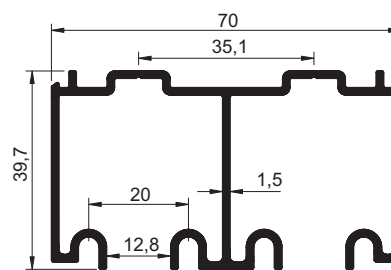
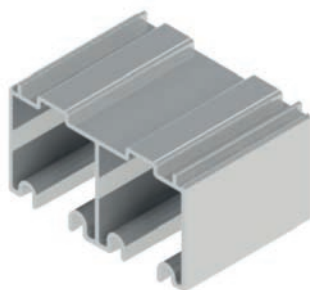

COMPATÍVEL · MONTAGEM  
**DES-262**

### DES-038

TRILHO SUPERIOR DUPLO  
0,572 Kg/m

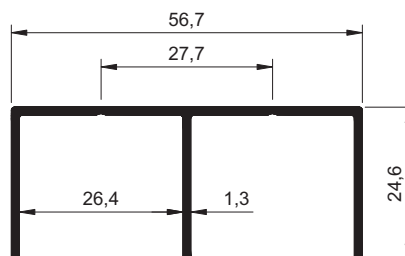

COMPATÍVEL · MONTAGEM  
**DES-512**  
**DES-049**  
**DES-294**  
**DES-058**  
**DES-113**

A ALUMICONTE reserva-se o direito de fazer modificações em qualquer informação escrita neste catálogo sem aviso prévio. Os desenhos aqui contidos possuem medidas teóricas de massa e tolerâncias dimensionais de acordo com a ABNT NBR-8116, podendo haver variações dessas informações no produto final.

## DES-156

TRILHO SUPERIOR DUPLO C/ ABA CONVEXA

0,479 Kg/m

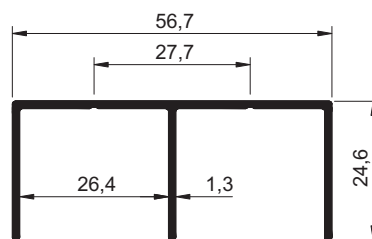

## DES-269

TRILHO SUPERIOR DUPLO C/ ABA CONVEXA

0,729 Kg/m

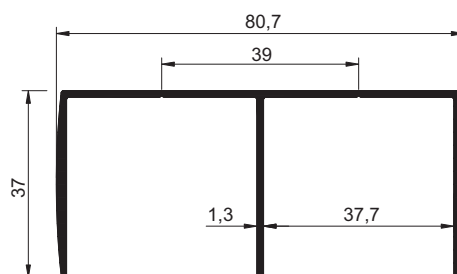

COMPATÍVEL · MONTAGEM

**DES-907**

**DES-824**

**DES-051**

**DES-228**

## DES-390

TRILHO SUPERIOR DUPLO

0,459 Kg/m

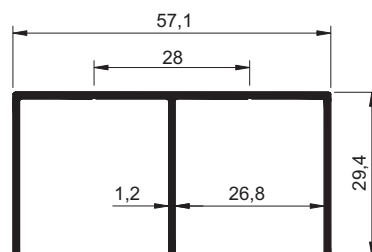

COMPATÍVEL · MONTAGEM

**DES-049**

**DES-512**

**DES-058**

**DES-113**

**DES-294**

## DES-032

TRILHO SUPERIOR DUPLO

0,665 Kg/m

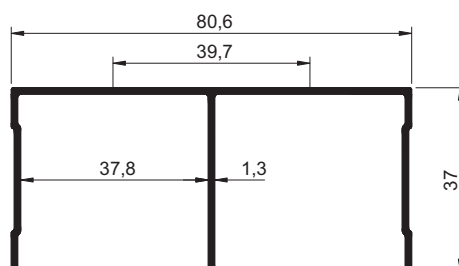

COMPATÍVEL · MONTAGEM

**DES-824**

**DES-051**

**DES-228**

**DES-907**



### DES-287

TRILHO SUPERIOR DUPLO C/ ABA CONVEXA  
0,589 Kg/m

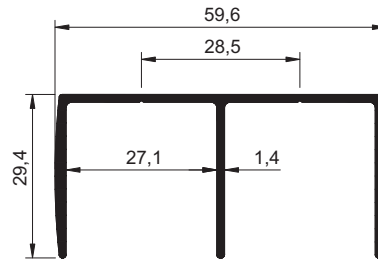
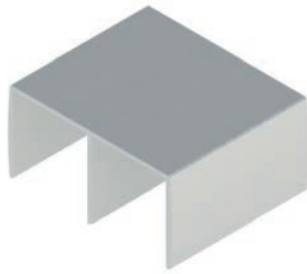

COMPATÍVEL · MONTAGEM

- DES-512**
- DES-294**
- DES-058**
- DES-113**
- DES-049**

### DES-340

TRILHO SUPERIOR DUPLO (ROLDANA CONVEXA)  
0,615 Kg/m

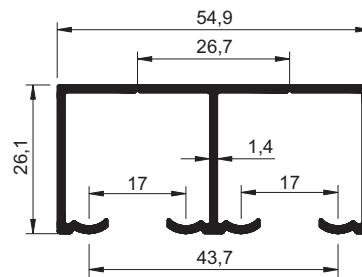
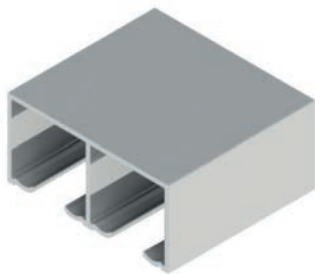

### DES-379

TRILHO SUP. TRIPLO/DUPLO (ROLDANA CONVEXA)  
0,751 Kg/m

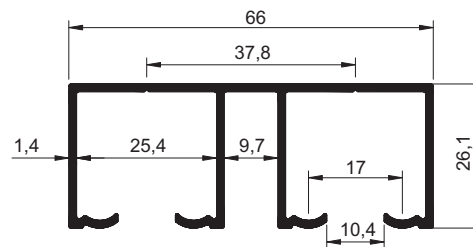
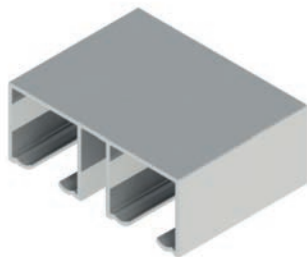

### DES-050A

TRILHO SUPERIOR DUPLO S/ ABA FRONTAL  
0,390 Kg/m

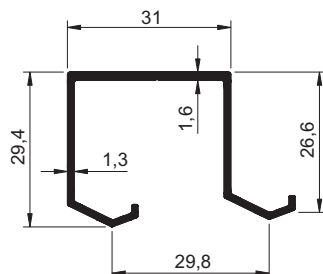
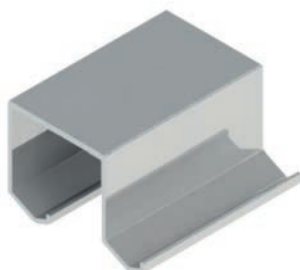

### DES-169

CAPA TRILHO SUPERIOR  
0,273 Kg/m

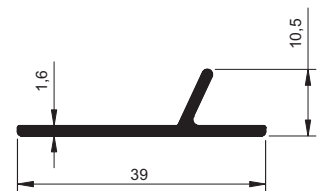

A ALUMICONTE reserva-se o direito de fazer modificações em qualquer informação escrita neste catálogo sem aviso prévio. Os desenhos aqui contidos possuem medidas teóricas de massa e tolerâncias dimensionais de acordo com a ABNT NBR-8116, podendo haver variações dessas informações no produto final.

## DES-480

TRILHO SUPERIOR DUPLO C/ ENCAIXE FREIO  
0,919 Kg/m



COMPATÍVEL · MONTAGEM

**DES-344**  
**DES-603**  
**DES-843**

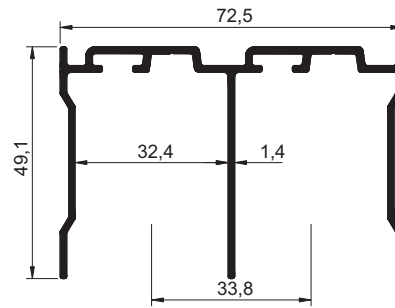

## DES-1434

TRILHO SUPERIOR DUPLO  
0,944 Kg/m

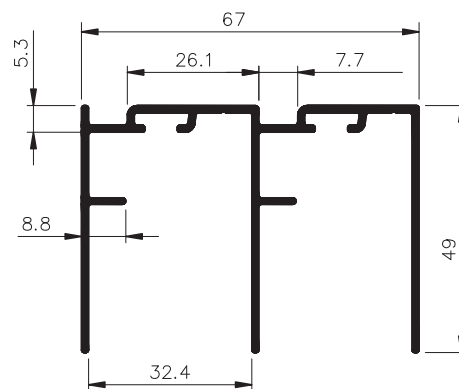
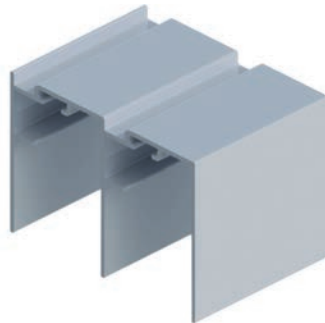

## DES-511

TRILHO SUPERIOR DUPLO C/ ENCAIXE LÂMINA  
0,476 Kg/m

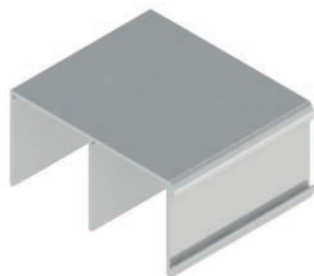

COMPATÍVEL · MONTAGEM

**DES-058**  
**DES-113**  
**DES-294**  
**DES-512**  
**DES-049**

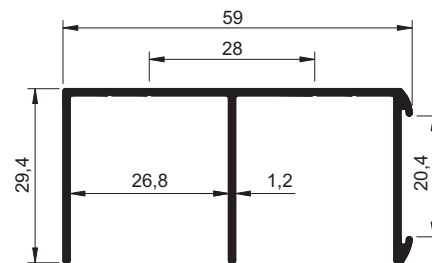

## DES-524

TRILHO SUPERIOR SUPERIOR DUPLO  
0,409 Kg/m



COMPATÍVEL · MONTAGEM

**DES-049**  
**DES-058**  
**DES-113**  
**DES-294**  
**DES-512**

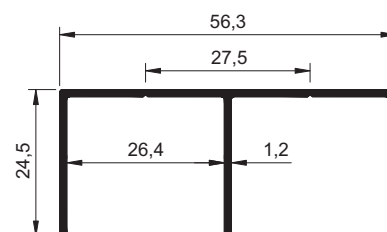

## DES-601

TRILHO SUPERIOR DUPLO  
0,550 Kg/m

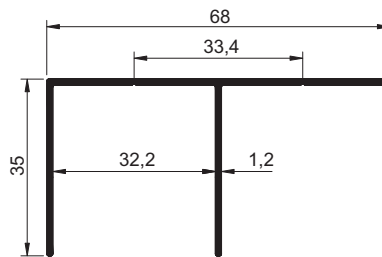

COMPATÍVEL · MONTAGEM

**DES-344**  
**DES-603**  
**DES-843**

## DES-813

TRILHO SUPERIOR DUPLO  
0,690 Kg/m

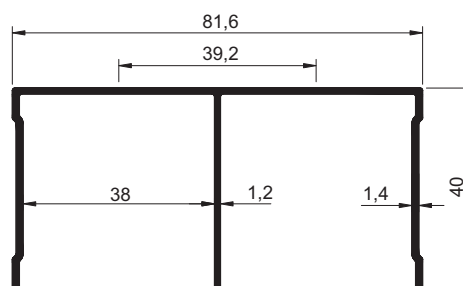

COMPATÍVEL · MONTAGEM

**DES-051**  
**DES-228**  
**DES-824**  
**DES-907**

## DES-844

TRILHO SUPERIOR DUPLO  
0,473 Kg/m

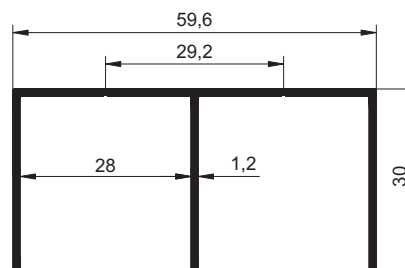

COMPATÍVEL · MONTAGEM

**DES-1284**  
**DES-188**  
**DES-042**  
**DES-287**

## DES-906

TRILHO SUPERIOR DUPLO C/ ENCAIXE FREIO  
0,742 Kg/m

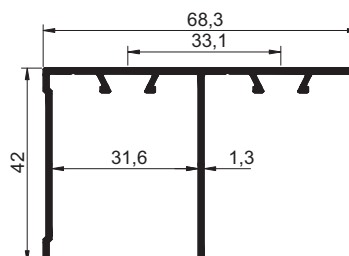
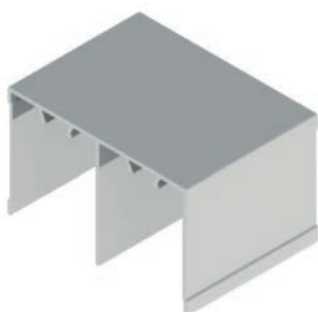

COMPATÍVEL · MONTAGEM

**DES-1344**  
**DES-603**  
**DES-843**

A ALUMICONTE reserva-se o direito de fazer modificações em qualquer informação escrita neste catálogo sem aviso prévio. Os desenhos aqui contidos possuem medidas teóricas de massa e tolerâncias dimensionais de acordo com a ABNT NBR-8116, podendo haver variações dessas informações no produto final.

## DES-1274

TRILHO SUPERIOR DUPLO - SISTEMA SUSPENSO

0,513 Kg/m

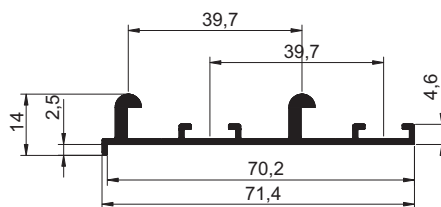

COMPATÍVEL · MONTAGEM

**DES-1275**



### DES-041

TRILHO INFERIOR SIMPLES  
0,124 Kg/m

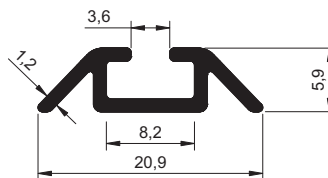
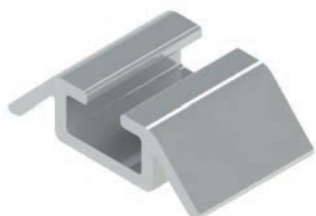

### DES-055

TRILHO INFERIOR SIMPLES DE EMBUTIR  
0,090 Kg/m

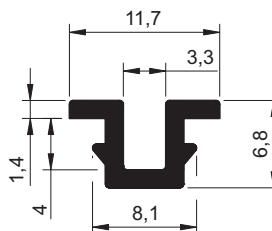

### DES-155

TRILHO INFERIOR SIMPLES  
0,085 Kg/m

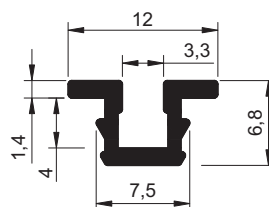

### DES-315

TRILHO INFERIOR SIMPLES DE EMBUTIR  
0,110 Kg/m

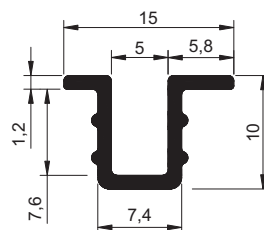

A ALUMICONTE reserva-se o direito de fazer modificações em qualquer informação escrita neste catálogo sem aviso prévio. Os desenhos aqui contidos possuem medidas teóricas de massa e tolerâncias dimensionais de acordo com a ABNT NBR-8116, podendo haver variações dessas informações no produto final.

## DES-042

TRILHO INFERIOR DUPLO

0,235 Kg/m

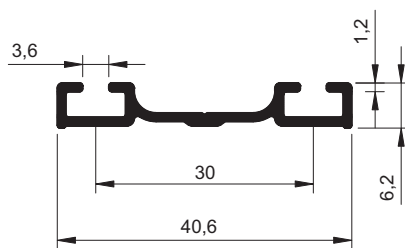

COMPATÍVEL · MONTAGEM

**DES-844**

## DES-113

TRILHO INFERIOR DUPLO

0,246 Kg/m

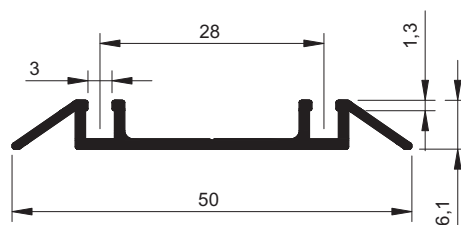

COMPATÍVEL · MONTAGEM

**DES-524**

**DES-511**

**DES-038**

**DES-287**

**DES-390**

## DES-294

TRILHO INFERIOR DUPLO

0,275 Kg/m

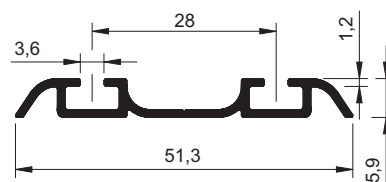
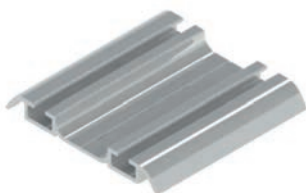

COMPATÍVEL · MONTAGEM

**DES-524**

**DES-511**

**DES-038**

**DES-287**

**DES-390**

## DES-512

TRILHO INFERIOR DUPLO

0,231 Kg/m

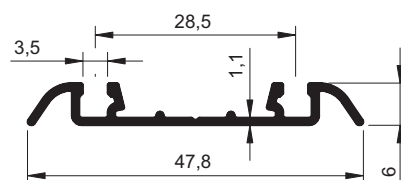

COMPATÍVEL · MONTAGEM

**DES-390**

**DES-524**

**DES-511**

**DES-038**

**DES-287**

### DES-188

TRILHO INFERIOR DUPLO  
0,337 Kg/m

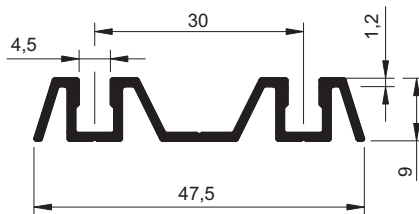

COMPATÍVEL · MONTAGEM  
**DES-844**

### DES-309

TRILHO INFERIOR DUPLO  
0,282 Kg/m

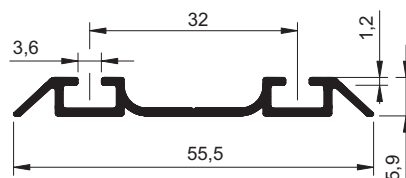
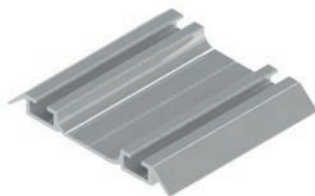

COMPATÍVEL · MONTAGEM  
**DES-817**

### DES-820

TRILHO INFERIOR DUPLO  
0,295 Kg/m

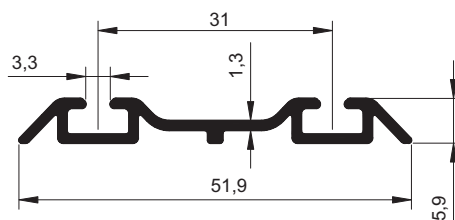
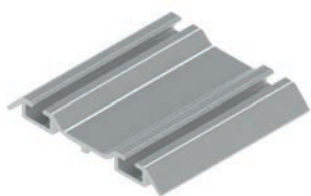

COMPATÍVEL · MONTAGEM  
**DES-817**

### DES-1284

TRILHO INFERIOR STB54  
0,288 Kg/m

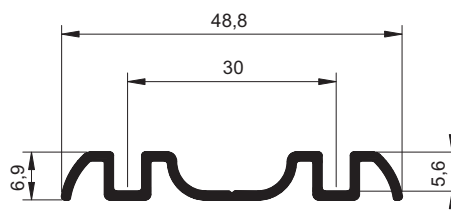

COMPATÍVEL · MONTAGEM  
**DES-844**

A ALUMICONTE reserva-se o direito de fazer modificações em qualquer informação escrita neste catálogo sem aviso prévio. Os desenhos aqui contidos possuem medidas teóricas de massa e tolerâncias dimensionais de acordo com a ABNT NBR-8116, podendo haver variações dessas informações no produto final.

## DES-228

TRILHO INFERIOR DUPLO

0,220 Kg/m

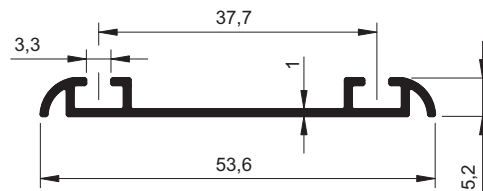

COMPATÍVEL · MONTAGEM

**DES-813**

**DES-516**

**DES-269**

**DES-032**

## DES-051

TRILHO INFERIOR DUPLO

0,313 Kg/m

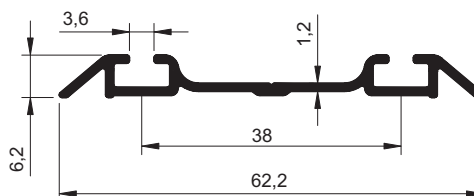
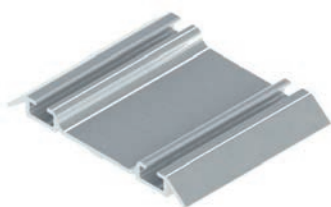

COMPATÍVEL · MONTAGEM

**DES-813,**

**DES-516**

**DES-032**

**DES-269**

## DES-344

TRILHO INFERIOR DUPLO

0,294 Kg/m

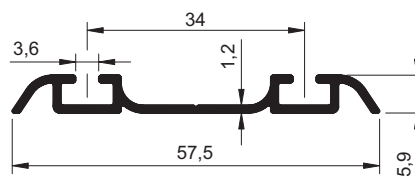
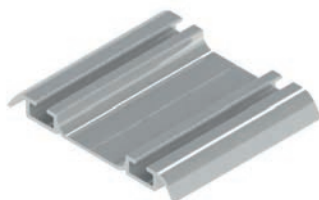

COMPATÍVEL · MONTAGEM

**DES-601**

**DES-906**

## DES-603

TRILHO INFERIOR DUPLO

0,238 Kg/m

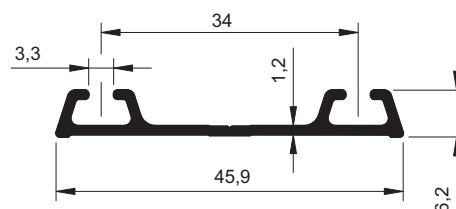
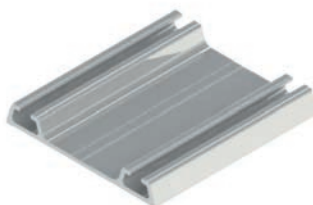

COMPATÍVEL · MONTAGEM

**DES-601**

**DES-906**



### DES-843

TRILHO INFERIOR DUPLO  
0,257 Kg/m

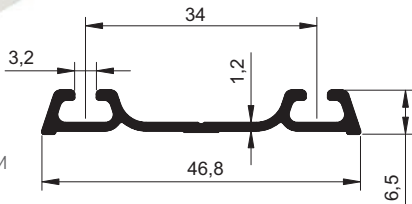
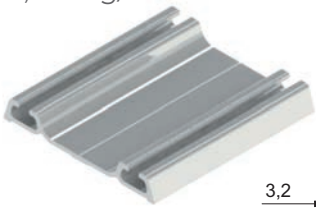

COMPATÍVEL · MONTAGEM  
**DES-601**  
**DES-906**

### DES-824

TRILHO INFERIOR DUPLO  
0,432 Kg/m

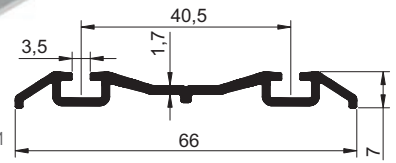
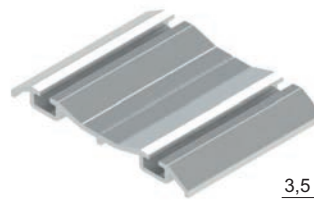

COMPATÍVEL · MONTAGEM  
**DES-813 | DES-516**  
**DES-269 | DES-032**

### DES-907

TRILHO INFERIOR DUPLO  
0,275 Kg/m

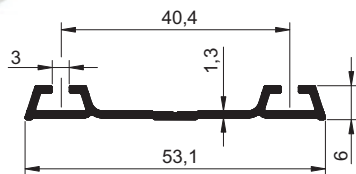
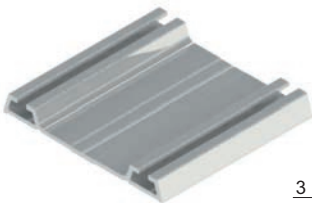

COMPATÍVEL · MONTAGEM  
**DES-813 | DES-516**  
**DES-269 | DES-032**

### DES-049

TRILHO INFERIOR DUPLO  
0,333 Kg/m

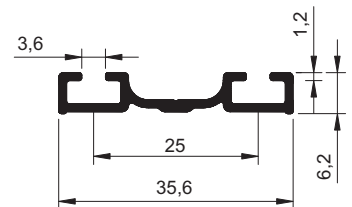
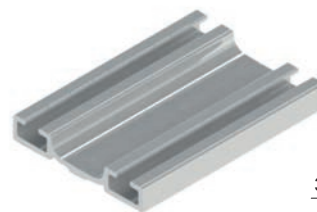

COMPATÍVEL · MONTAGEM  
**DES-524 | DES-511**  
**DES-390 | DES-287 | DES-038**

### DES-058

TRILHO INFERIOR DUPLO  
0,275 Kg/m

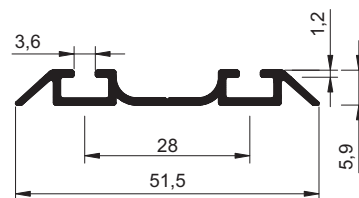
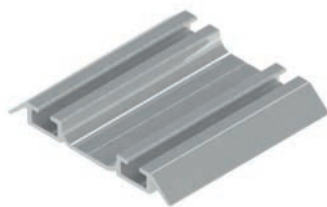

COMPATÍVEL · MONTAGEM  
**DES-524**  
**DES-511**  
**DES-390**  
**DES- 287**  
**DES-038**

### DES-836

TRILHO LINEAR - SISTEMA DESLIZANTE VIDRO  
0,375 Kg/m

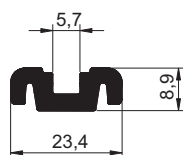

### DES-1275

TRILHO INFERIOR DUPLO - SISTEMA SUSPENSO  
0,697 Kg/m

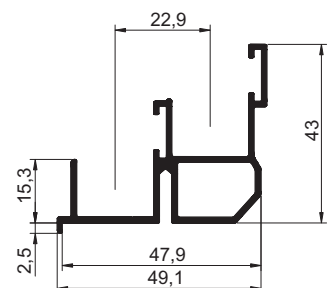
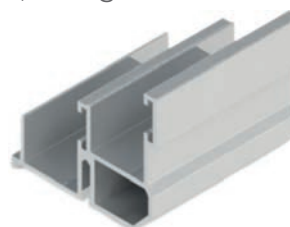

COMPATÍVEL · MONTAGEM  
**DES-1274**

A ALUMICONTE reserva-se o direito de fazer modificações em qualquer informação escrita neste catálogo sem aviso prévio. Os desenhos aqui contidos possuem medidas teóricas de massa e tolerâncias dimensionais de acordo com a ABNT NBR-8116, podendo haver variações dessas informações no produto final.



**PERFIS TESTEIRA,  
MONTANTE PUXADOR,  
DIVISÓRIA,  
PORTA E VITRINE**

**ACABAMENTOS & CORES**

**Natural**

**Anodizado**

Fosco | Bronze 1001 | 1002 | 1003 | Preto

**Jateado e Anodizado**

Fosco | Bronze 1001 | 1002 | 1003 | Preto

**Escovado e Anodizado**

Inox | Preto

**Pintura Eletrostática**

### DES-143

TESTEIRA PERIMETRAL 18mm  
0,157 Kg/m

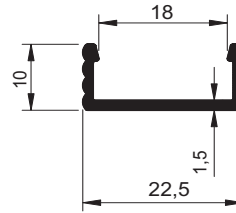

### DES-248

TESTEIRA PERIMETRAL 18mm  
0,207 Kg/m

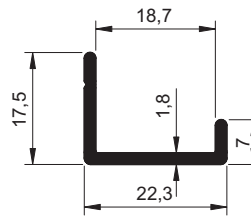

### DES-693

TESTEIRA PERIMETRAL 18mm  
0,272 Kg/m

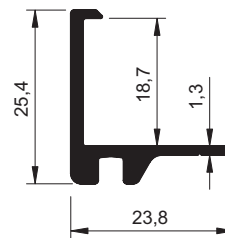

### DES-292

TESTEIRA PERIMETRAL 18mm  
0,256 Kg/m

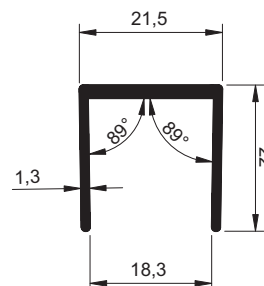
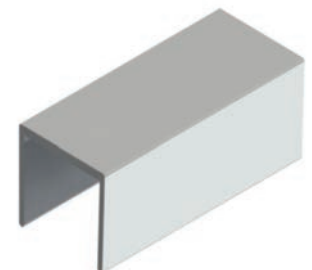

A ALUMICONTE reserva-se o direito de fazer modificações em qualquer informação escrita neste catálogo sem aviso prévio. Os desenhos aqui contidos possuem medidas teóricas de massa e tolerâncias dimensionais de acordo com a ABNT NBR-8116, podendo haver variações dessas informações no produto final.

## DES-694

TESTEIRA PERIMETRAL 18mm

0,165 Kg/m

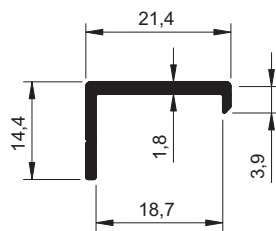
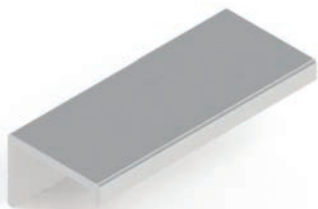

## DES-249

TESTEIRA PERIMETRAL 15mm

0,193 Kg/m

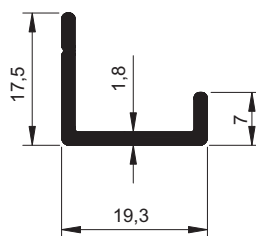

## DES-1620

TESTEIRA PERIMETRAL 15mm

0,150 Kg/m

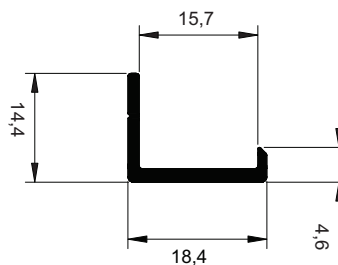

## DES-165

TRILHO / TESTEIRA 15mm

0,277 Kg/m

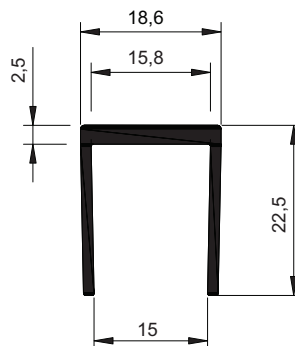
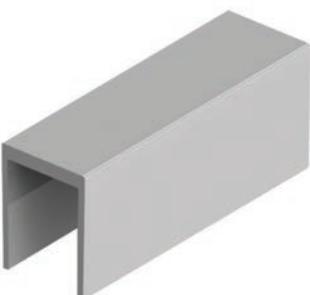

## DES-205

TRILHO / TESTEIRA PERIMETRAL 15mm  
0,371 Kg/m

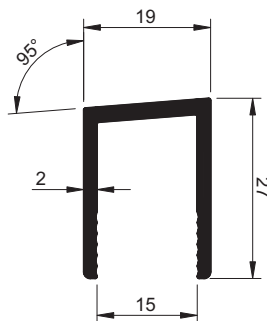

## DES-150

TESTEIRA PERIMETRAL C/ ESPIGA  
0,168 Kg/m

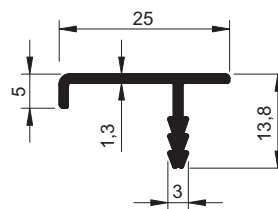
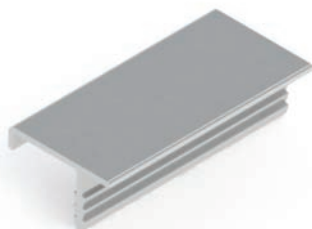

## DES-884

TESTEIRA PERIMETRAL C/ ESPIGA  
0,193 Kg/m

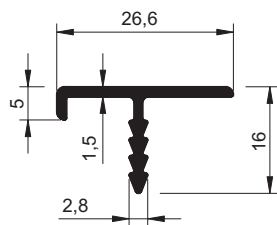
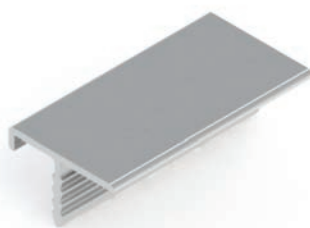

## DES-241

TESTEIRA PERIMETRAL C/ ESPIGA P/ MDF 15mm  
0,172 Kg/m

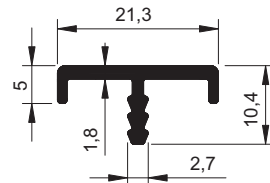

## DES-240

TESTEIRA PERIMETRAL C/ ESPIGA P/ MDF 15mm  
0,157 Kg/m

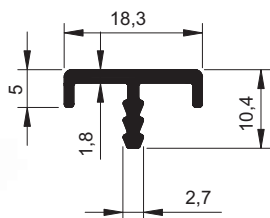

## DES-293

TESTEIRA PERIMETRAL 15mm C/ PUXADOR CÔNCAVO  
0,257 Kg/m

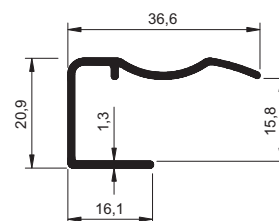

**DES-104**

MONTANTE PUXADOR PORTA CORRER 15mm

0,524 Kg/m

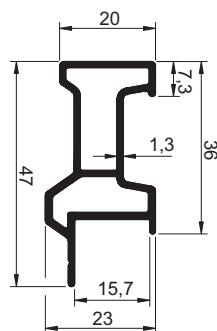
**DES-290**

MONTANTE PUXADOR PORTA CORRER 15mm

0,421 Kg/m

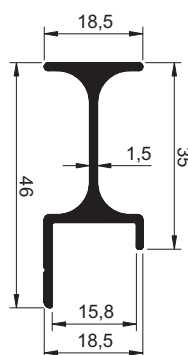
**DES-307**

MONTANTE PUXADOR PORTA CORRER 15mm

0,396 Kg/m

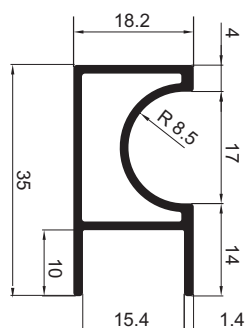
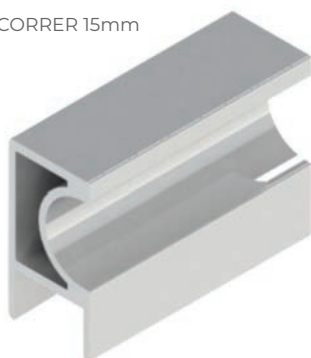
**DES-127**

MONTANTE PUXADOR PORTA CORRER 18mm

0,214 Kg/m

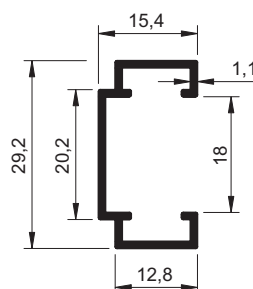

**DES-291**

MONTANTE PUXADOR PORTA CORRER 18mm

0,445 Kg/m

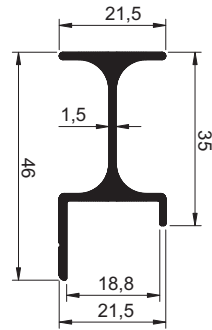
**DES-121**

MONTANTE PUXADOR PORTA CORRER 15mm

0,450 Kg/m

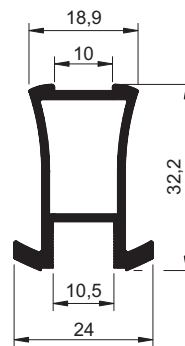
**DES-334**

MONTANTE PUXADOR PORTA CORRER

0,613 Kg/m

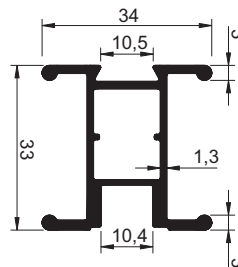
**DES-259**

MONTANTE PUXADOR PORTA CORRER

0,680 Kg/m

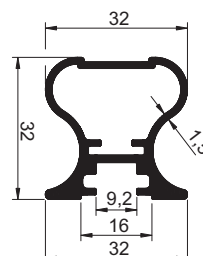

COMPATÍVEL · MONTAGEM

**DES-257****DES-258****DES-260****DES-257**

## DES-675

MONTANTE VIDRO PORTA CORRER  
0,490 Kg/m

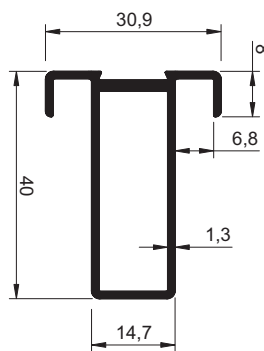

## DES-810

MONTANTE PUXADOR PORTA CORRER  
0,425 Kg/m

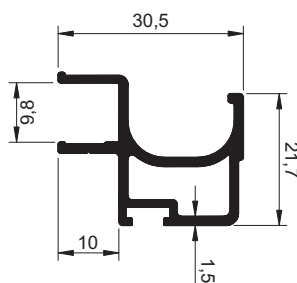

COMPATÍVEL · MONTAGEM  
**DES-812**

## DES-819

MONTANTE PUXADOR PORTA CORRER  
0,406 Kg/m

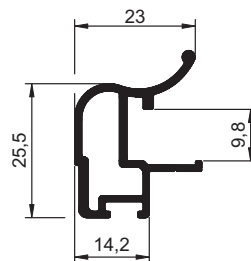
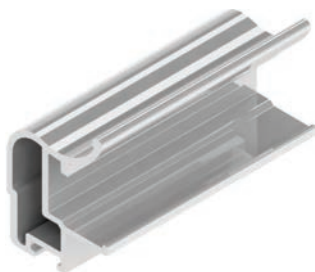

## DES-822

MONTANTE PUXADOR PORTA CORRER  
0,562 Kg/m

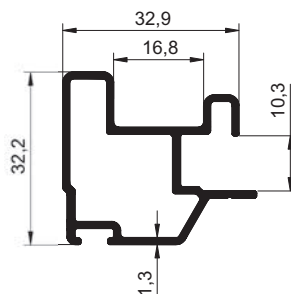
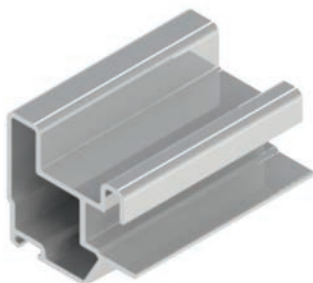



### DES-846

MONTANTE PUXADOR PORTA CORRER  
0,717 Kg/m

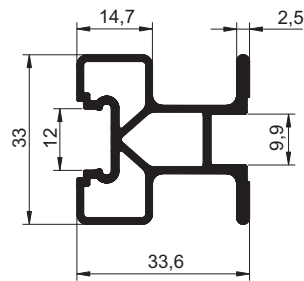
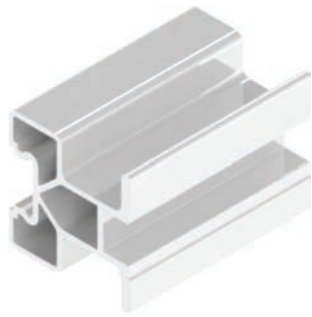

### DES-257

TRAVESSA INFERIOR PARA PORTA DESLIZANTE  
0,594 Kg/m

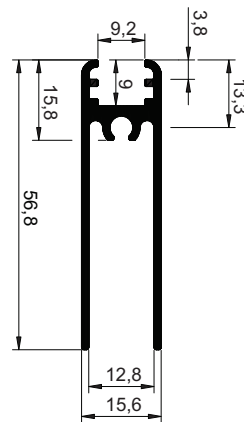
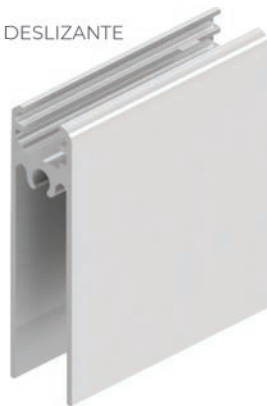

### DES-258

TRAVESSA INTERMEDIARIA PORTA CORRER  
0,491 Kg/m

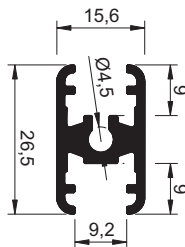

COMPATÍVEL · MONTAGEM  
DES-257 | DES-259 | DES-260

### DES-260

TRAVESSA SUPERIOR 8mm  
0,749 Kg/m

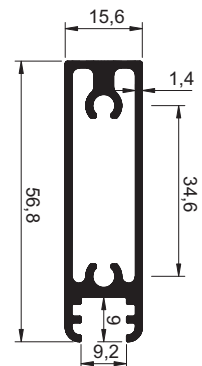

### DES-812

TRAVESSA SUPERIOR/INFERIOR PORTA CORRER  
0,409 Kg/m

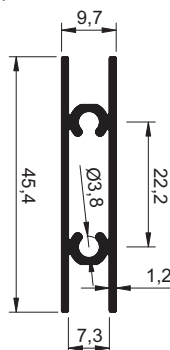

COMPATÍVEL · MONTAGEM  
DES-810

### DES-874

TRAVESSA SUPERIOR/INFERIOR PORTA CORRER  
0,279 Kg/m

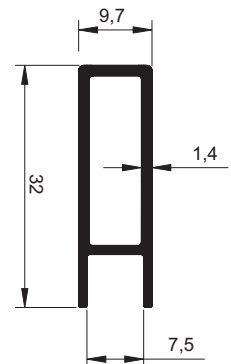

A ALUMICONTE reserva-se o direito de fazer modificações em qualquer informação escrita neste catálogo sem aviso prévio. Os desenhos aqui contidos possuem medidas teóricas de massa e tolerâncias dimensionais de acordo com a ABNT NBR-8116, podendo haver variações dessas informações no produto final.

## DES-302

MONTANTE DIVISÓRIA AMBIENTE  
0,896 Kg/m

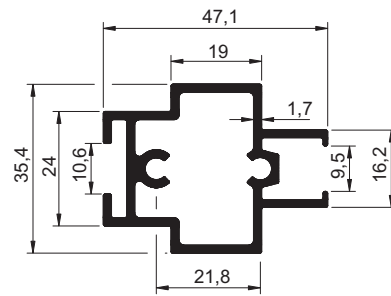
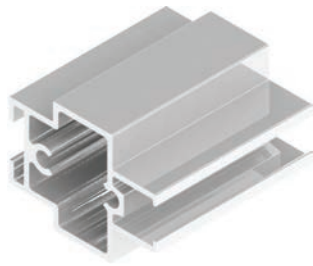

COMPATÍVEL · MONTAGEM

**DES-303**  
**DES-304**

## DES-303

MONTANTE DIVISÓRIA AMBIENTE  
0,682 Kg/m

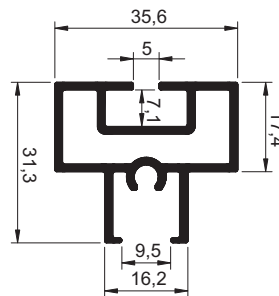
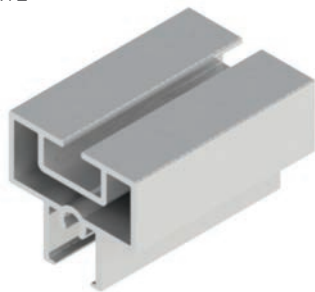

COMPATÍVEL · MONTAGEM

**DES-303**  
**DES-304**

## DES-304

MONTANTE DIVISÓRIA AMBIENTE  
0,740 Kg/m

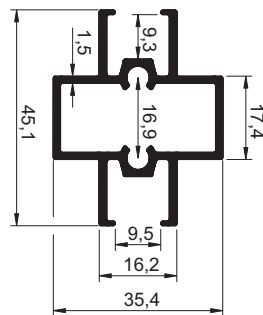
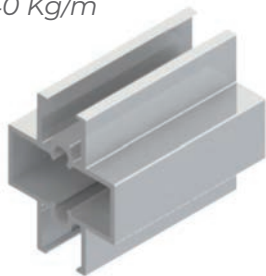

COMPATÍVEL · MONTAGEM

**DES-303 | DES-302**

## DES-596

DIVISÓRIA AMBIENTE 15mm  
0,283 Kg/m

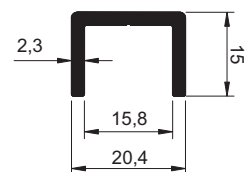
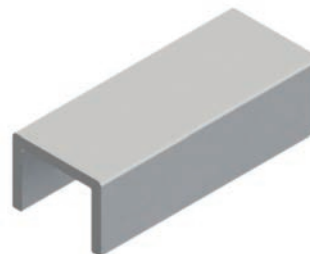

## DES-599

TRAVESSA INFERIOR. DIVISÓRIA AMBIENTE  
0,758 Kg/m

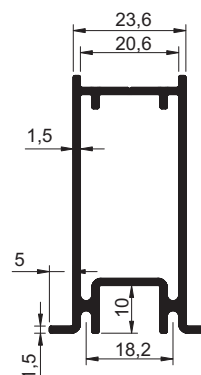

COMPATÍVEL · MONTAGEM

**DES-597**  
**DES-598**  
**DES-600**

## DES-600

TRAVESSA SUPERIOR DIVISÓRIA AMBIENTE  
0,810 Kg/m

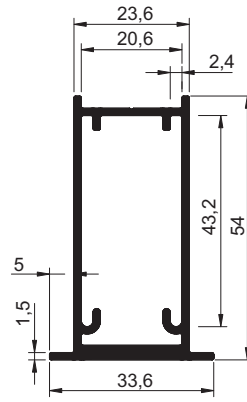
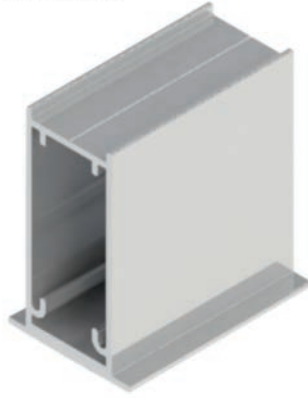

COMPATÍVEL · MONTAGEM

- DES-597**
- DES-598**
- DES-599**

## DES-1293

QUADRO VIDRO DUPLO  
2,450 Kg/m  
90 x 42 x 5mm

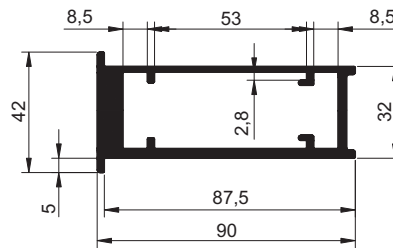
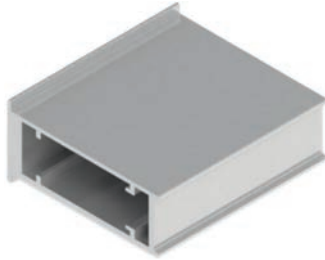

COMPATÍVEL · MONTAGEM

- DES-1294**
- DES-1295**

## DES-799

TRAVESSA INTERM. DIVISÓRIA AMBIENTE  
0,829 Kg/m

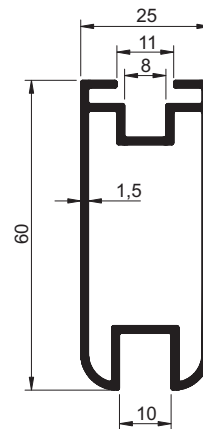

## DES-597

TRAVESSA INTERM. DUPLA DIVISÓRIA AMBIENTE  
0,533 Kg/m

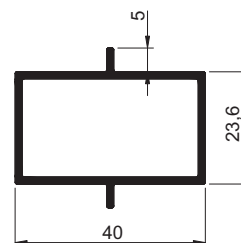
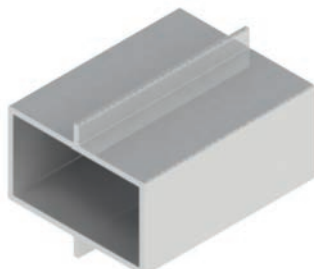

COMPATÍVEL · MONTAGEM

- DES-600**
- DES-599**
- DES-598**

A ALUMICONTE reserva-se o direito de fazer modificações em qualquer informação escrita neste catálogo sem aviso prévio. Os desenhos aqui contidos possuem medidas teóricas de massa e tolerâncias dimensionais de acordo com a ABNT NBR-8116, podendo haver variações dessas informações no produto final.

## DES-598

TRAVESSA INTERM. DIVISÓRIA AMBIENTE  
0,513 Kg/m

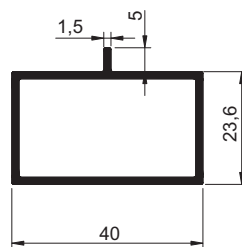
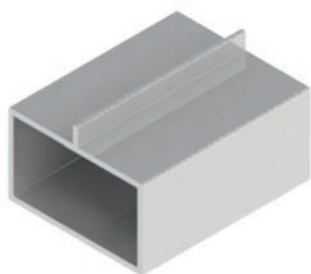

COMPATÍVEL · MONTAGEM

**DES-597**  
**DES-599**  
**DES-600**

## DES-1481

TRAVESSA INTERMEDIÁRIA DUPLA  
1,314 Kg/m

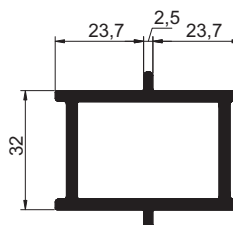
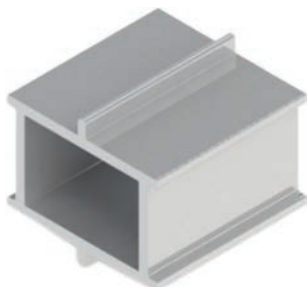

COMPATÍVEL · MONTAGEM

**DES-1293**  
**DES-1482**  
**DES-1483**

## DES-1482

TRAVESSA INTERMEDIÁRIA  
1,280 Kg/m

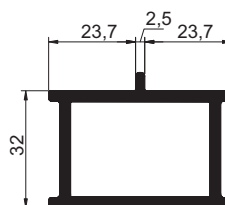
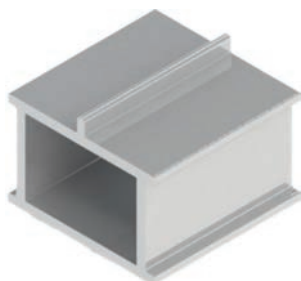

COMPATÍVEL · MONTAGEM

**DES-1293**  
**DES-1481**  
**DES-1483**

## DES-1483

TRAVESSA INTERMEDIÁRIA  
1,246 Kg/m

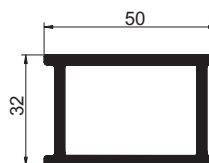
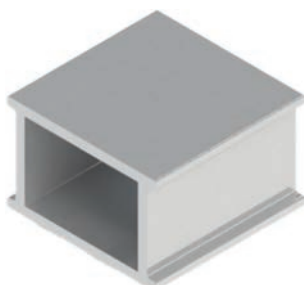

COMPATÍVEL · MONTAGEM

**DES-1293**  
**DES-1481**  
**DES-1482**

**DES-075**

ESTRUTURAL VITRINE 30X50

1,123 Kg/m

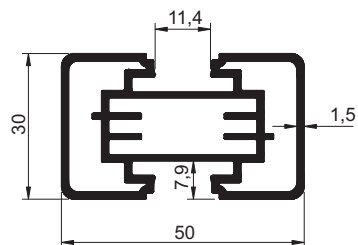
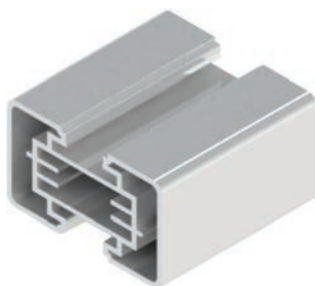
**DES-335**

ESTRUTURAL "C"

2,518 Kg/m

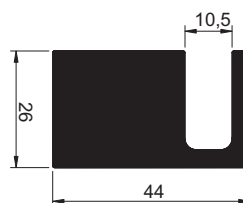
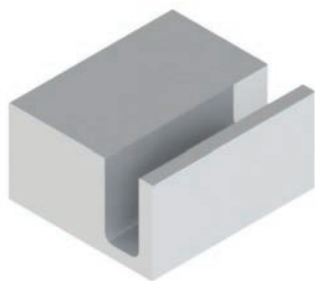
**DES-336**

ESTRUTURAL "U"

1,774 Kg/m

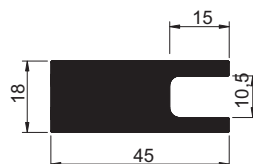
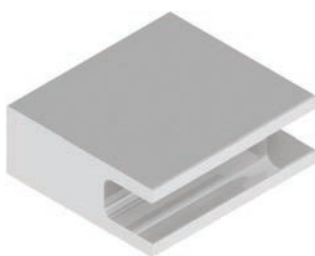
**DES-366**

ESTRUTURAL PERIMETRAL VIDRO IO

0,687 Kg/m

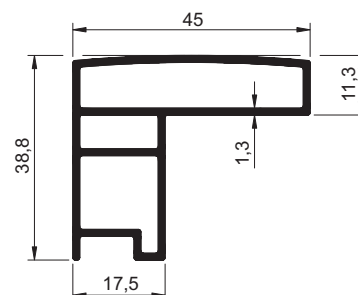
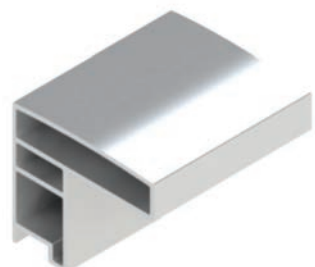

## DES-400

ESTRUTURAL INDUSTRIAL 100X30

1,858 Kg/m

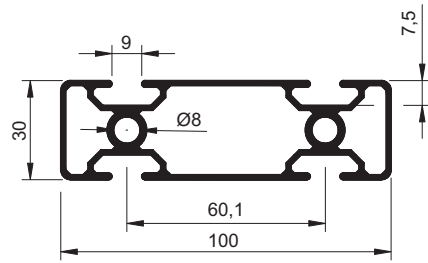

## DES-894

ESTRUTURAL MÓVEL

1,662 Kg/m

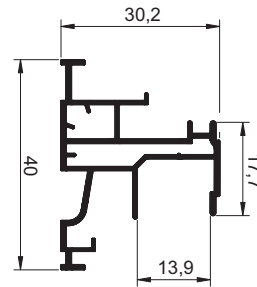

## DES-932

ESTRUTURAL VITRINE 41x40

1,081 Kg/m

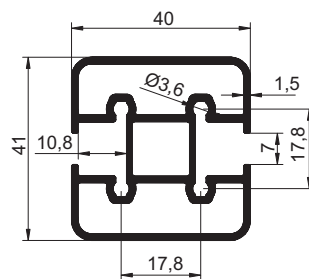
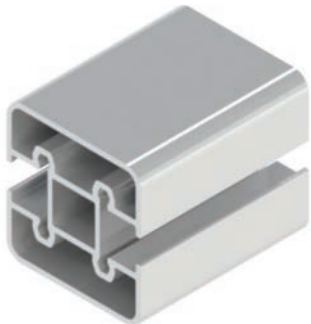

## DES-987

ESTRUTURAL 104x31

1,234 Kg/m

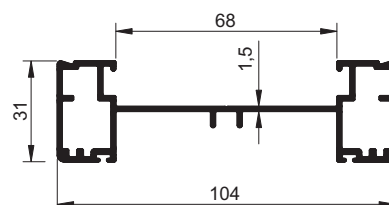

COMPATÍVEL · MONTAGEM

DES-988

## DES-988

TAMPA CÔNCAVA DES-987

0,517 Kg/m

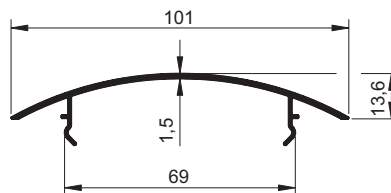

COMPATÍVEL · MONTAGEM  
**DES-987**

## DES-1289

ESTRUTURAL TRAVESSA QUADRO

1,445 Kg/m

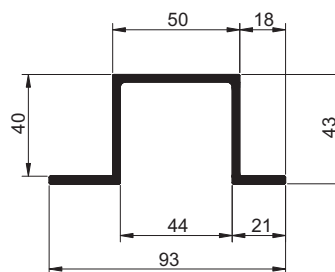
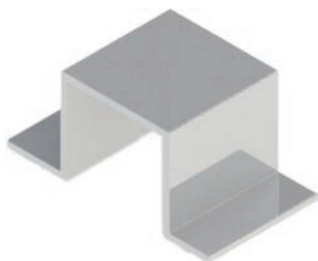

## DES-1445

MONTANTE ESTRUTURAL

0,758 Kg/m

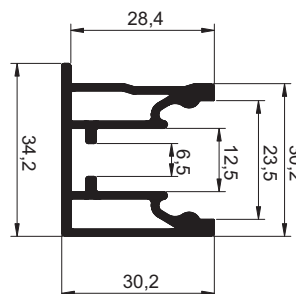

COMPATÍVEL · MONTAGEM  
**DES-1413**

## DES-1412

MONTANTE ESTRUTURAL

0,741 Kg/m

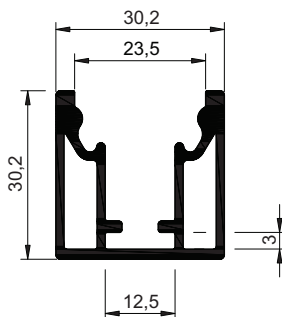
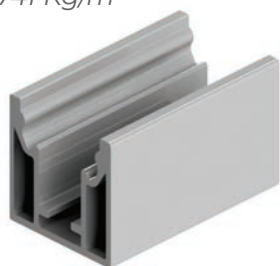

COMPATÍVEL · MONTAGEM  
**DES-1413**

## DES-1413

CAPA MONTANTE ESTRUTURAL

0,230 Kg/m

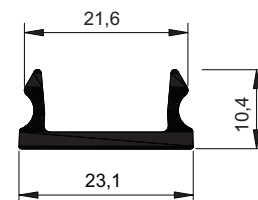
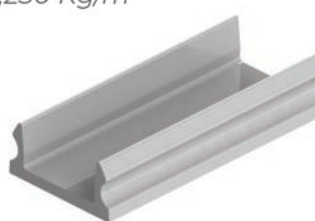

COMPATÍVEL · MONTAGEM  
**DES-1412**  
**DES-1445**

A ALUMICONTE reserva-se o direito de fazer modificações em qualquer informação escrita neste catálogo sem aviso prévio. Os desenhos aqui contidos possuem medidas teóricas de massa e tolerâncias dimensionais de acordo com a ABNT NBR-8116, podendo haver variações dessas informações no produto final.

**DES-671**

LINEAR VIDRO 10 VITRINE EXPOSITOR

0,565 Kg/m

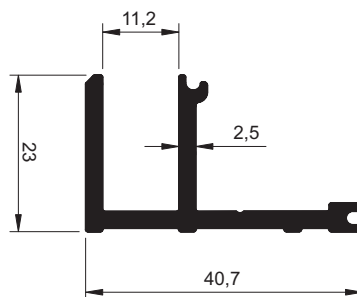
**DES-672**

LINEAR VIDRO 8 VITRINE/EXPOSITOR

0,552 Kg/m

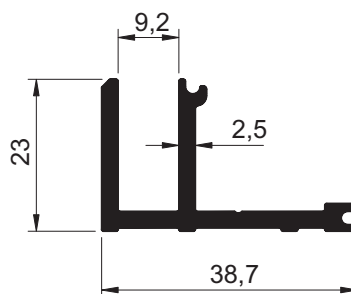

COMPATÍVEL · MONTAGEM

**DES-674****DES-673**

LINEAR VIDRO 6 VITRINE/EXPOSITOR

0,538 Kg/m

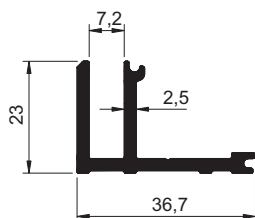
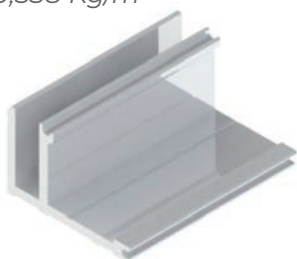

COMPATÍVEL · MONTAGEM

**DES-674****DES-674**

CAPA-VITRINE/EXPOSITOR

0,157 Kg/m

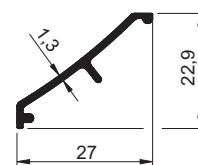

COMPATÍVEL · MONTAGEM

**DES-671 | DES-672 | DES-673****DES-740**

PERFIL "X" C/ ESIPIGA VITRINE/EXPOSITOR

0,212 Kg/m

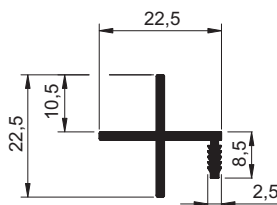
**DES-741**

PERFIL "U" C/ ESIPIGA VITRINE EXPOSITOR

0,216 Kg/m

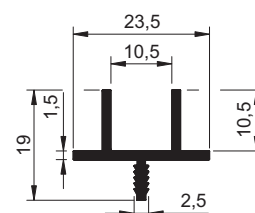





## PERFIS DIVERSOS

Aqui você encontra uma seleção com diversos modelos de perfis que podem ser utilizados em uma variada gama de aplicações.

### ACABAMENTOS & CORES

**Natural**

**Anodizado**

Fosco | Bronze 1001 | 1002 | 1003 | Preto

**Jateado e Anodizado**

Fosco | Bronze 1001 | 1002 | 1003 | Preto

**Escovado e Anodizado**

Inox | Preto

**Pintura Eletrostática**

### DES-052

TUBO CABIDEIRO REDONDO  
0,249 Kg/m

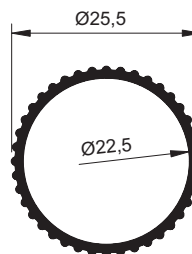

### DES-157

CABIDEIRO SEÇÃO SEMI-TUBULAR  
0,299 Kg/m

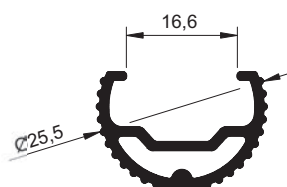

### DES-387

TUDO RETANGULAR 25,4x23  
0,312 Kg/m

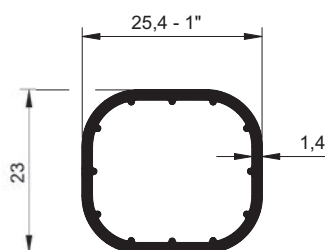

### DES-161

CABIDEIRO OBLONGO  
0,262 Kg/m

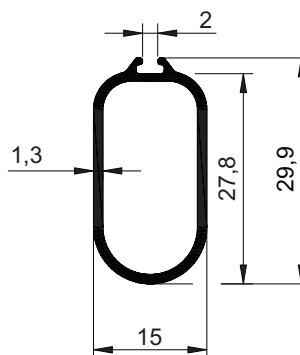

### DES-163

CABIDEIRO OBLONGO  
0,189 Kg/m

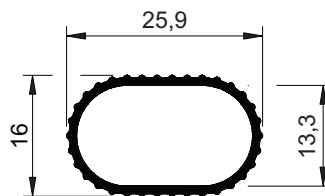
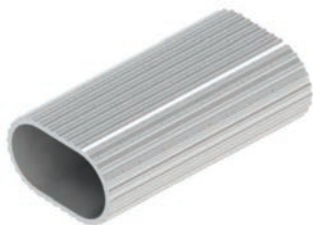

### DES-271

CABIDEIRO OBLONGO  
0,223 Kg/m

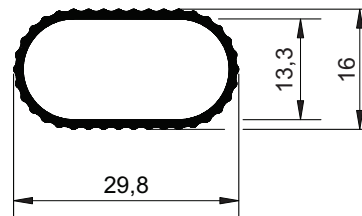
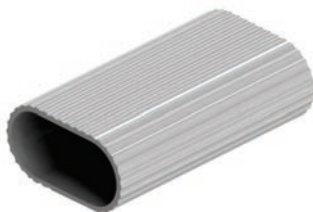

### DES-1511

PUXADOR INTERNO MONTANTE  
0,478 Kg/m

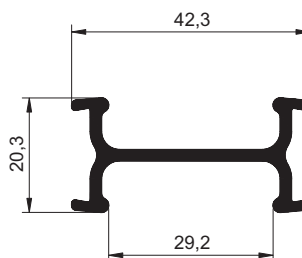
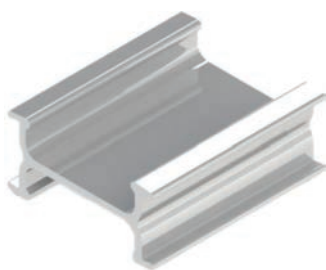

COMPATÍVEL · MONTAGEM

**DES-1510**

**DES-1512**

**DES-1514**

### DES-100

PERPENDICULAR NÍVEL DE ALUMÍNIO  
0,786 Kg/m

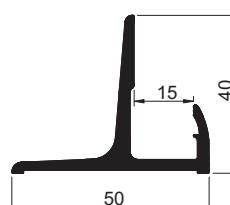

A ALUMICONTE reserva-se o direito de fazer modificações em qualquer informação escrita neste catálogo sem aviso prévio. Os desenhos aqui contidos possuem medidas teóricas de massa e tolerâncias dimensionais de acordo com a ABNT NBR-8116, podendo haver variações dessas informações no produto final.

### DES-098

PERFIL PERPENDICULAR NÍVEL DE ALUMÍNIO  
0,383 Kg/m



### DES-181

PERFIL "I" PARARELO NÍVEL DE ALUMÍNIO  
0,315 Kg/m

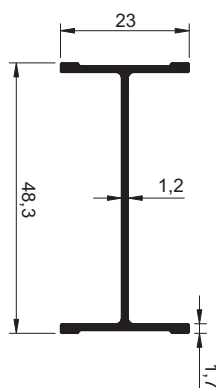

### DES-099

PARARELO NÍVEL DE ALUMÍNIO  
0,431 Kg/m

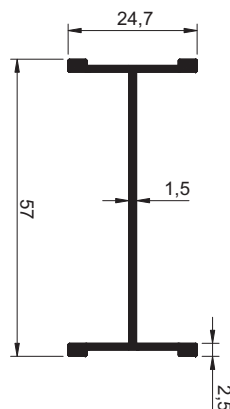

### DES-1277

CANALETA ELÉTRICA  
0,336 Kg/m

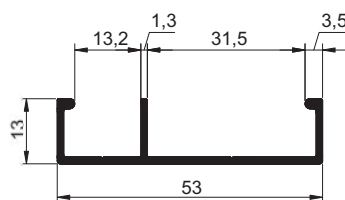
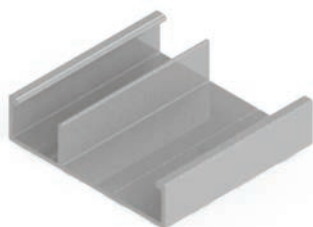

COMPATÍVEL · MONTAGEM

**DES-1276**

### DES-1276

TAMPA CANALETA ELÉTRICA  
0,203 Kg/m

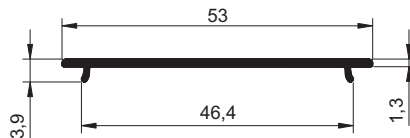
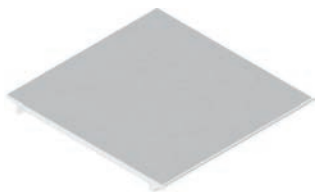

COMPATÍVEL · MONTAGEM  
**DES-1277**

### DES-079

TUDO ELIPSE 18x12  
0,163 Kg/m

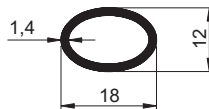

### DES-851

TUBULAR SUPORTE TV | LED  
1,437 Kg/m

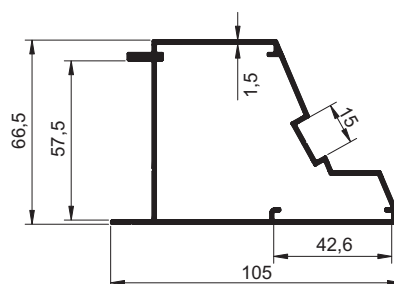

### DES-852

TUBULAR SUPORTE TV | LED  
0,927 Kg/m

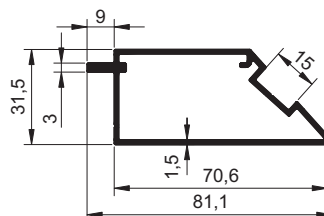

A ALUMICONTE reserva-se o direito de fazer modificações em qualquer informação escrita neste catálogo sem aviso prévio. Os desenhos aqui contidos possuem medidas teóricas de massa e tolerâncias dimensionais de acordo com a ABNT NBR-8116, podendo haver variações dessas informações no produto final.

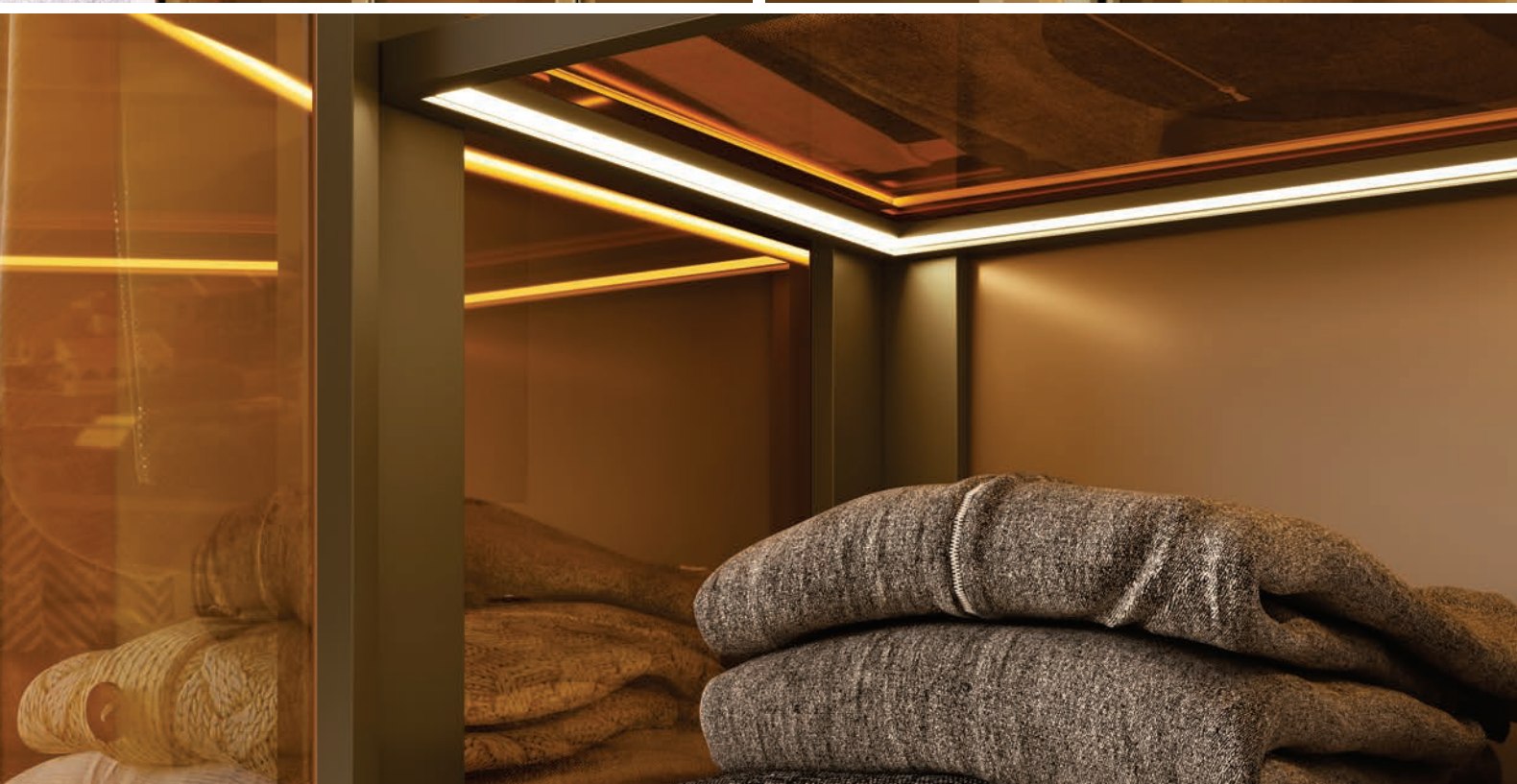
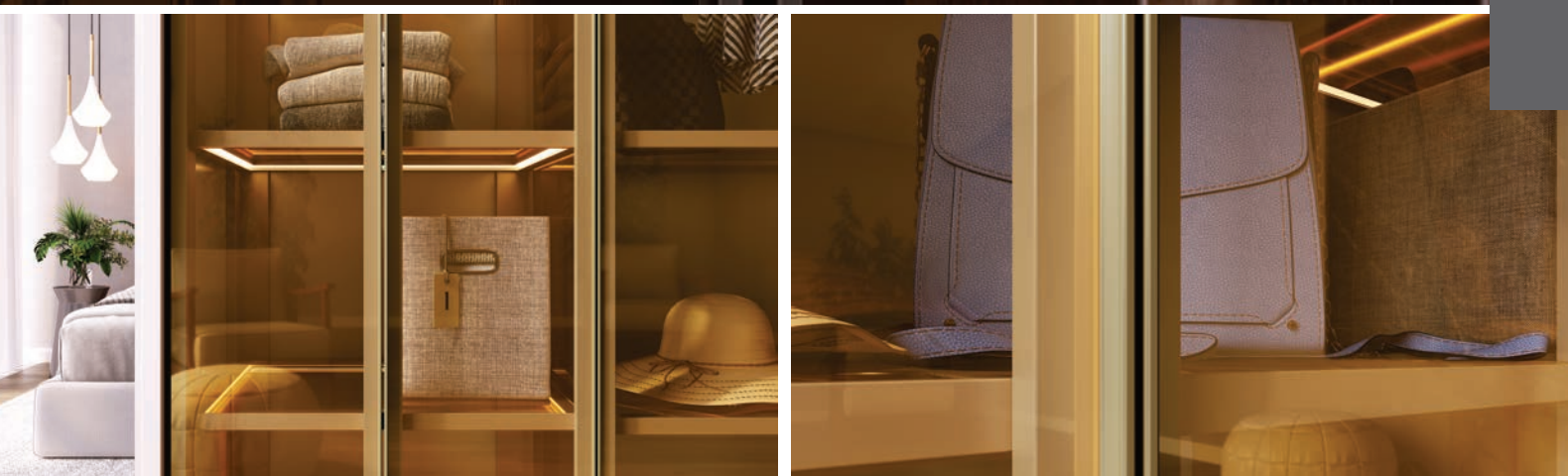

### DES-1298

QUADRO PAINEL TV  
2,434 Kg/m

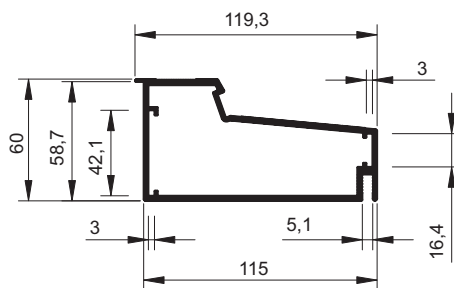
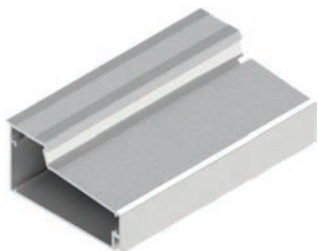

### DES-1303

QUADRO PAINEL TV  
0,946 Kg/m

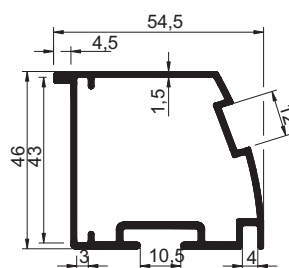
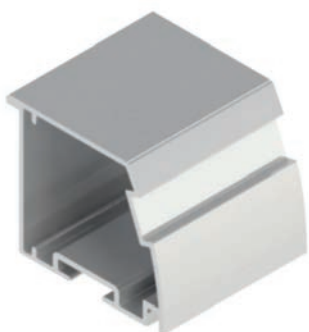

### DES-1304

QUADRO DO VIDRO SISTEMA PRATELEIRA LED  
0,709 Kg/m

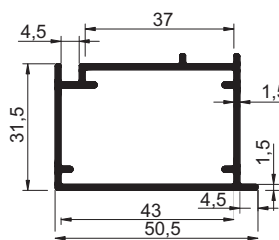

### DES-1443

BORDA LUMINÁRIA LED  
0,152 Kg/m

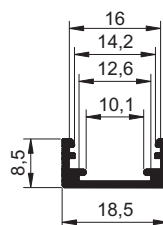

A ALUMICONTE reserva-se o direito de fazer modificações em qualquer informação escrita neste catálogo sem aviso prévio. Os desenhos aqui contidos possuem medidas teóricas de massa e tolerâncias dimensionais de acordo com a ABNT NBR-8116, podendo haver variações dessas informações no produto final.

## DES-1444

BORDA LUMINÁRIA LED  
0,163 Kg/m

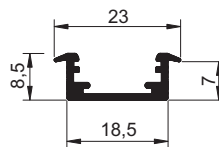

## DES-097

TUBO REDONDO 2"x1,2  
0,507 Kg/m

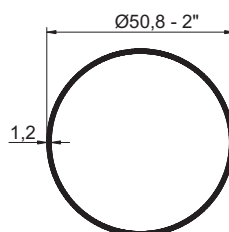

## DES-289

TUBO REDONDO 1/2"x1,6  
0,150 Kg/m

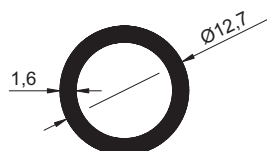

## DES-342

TUBO REDONDO 1"x6,45  
1,041 Kg/m

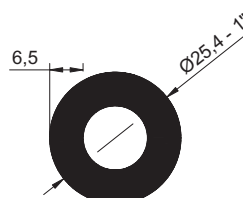



**DES-1455**

TUBO 3/8" x 1,2 mm  
0,089 Kg/m

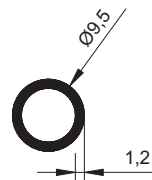

**BXT-497**

TUBO 19,05x1,3mm  
0,199 Kg/m

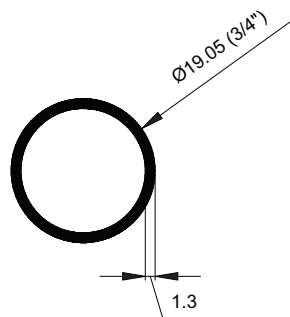

**BXT-499**

TUBO 1,1/2x1,3mm  
0,413 Kg/m

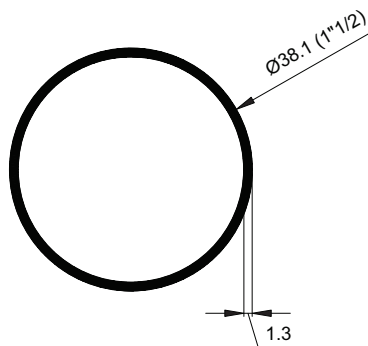

**BXT-500**

TUBO 1"x1,3mm  
0,271 Kg/m

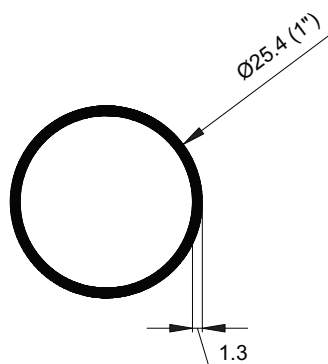

A ALUMICONTE reserva-se o direito de fazer modificações em qualquer informação escrita neste catálogo sem aviso prévio. Os desenhos aqui contidos possuem medidas teóricas de massa e tolerâncias dimensionais de acordo com a ABNT NBR-8116, podendo haver variações dessas informações no produto final.

## DES-1294

MARCO REGULÁVEL  
0,956 Kg/m

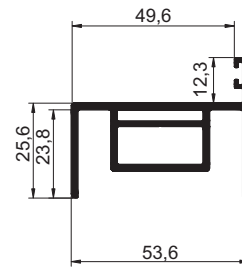
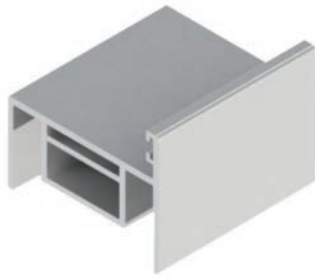

COMPATÍVEL · MONTAGEM

**DES-1293**  
**DES-1295**

## DES-1295

ESTRUTURAL MARCO REGULÁVEL  
0,445 Kg/m

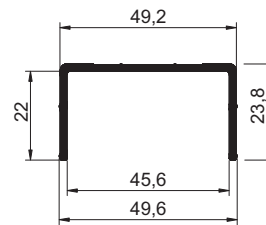
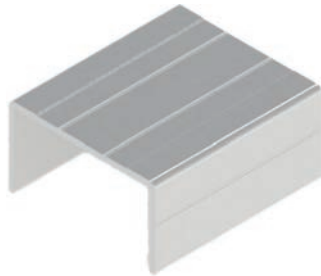

COMPATÍVEL · MONTAGEM

**DES-1293**  
**DES-1294**

## DES-1721

PERFIL MENOR MARCO REGULÁVEL  
0,928 Kg/m

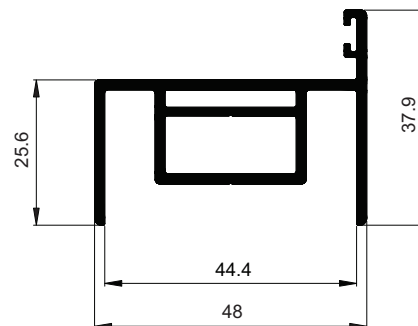
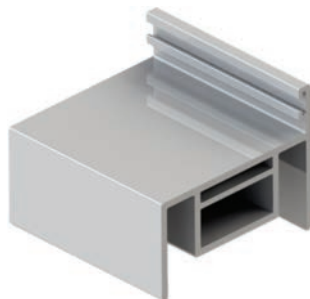

## DES-1722

PERFIL MENOR ESTRUTURAL MARCO REGULÁVEL  
0,418 Kg/m

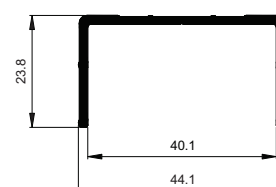
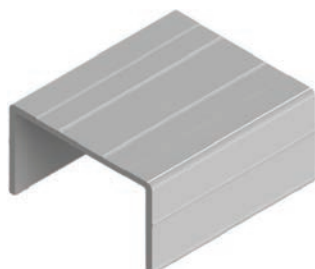

## DES-1302

MARCO PERIMETRAL  
0,347 Kg/m

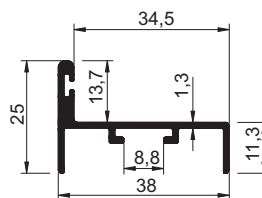
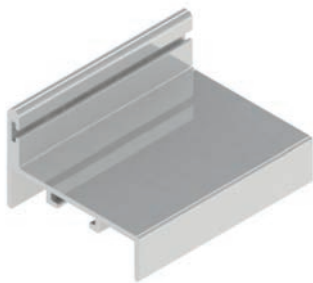

## DES-1510

MONTANTE VIDRO DUPLO  
0,961 Kg/m

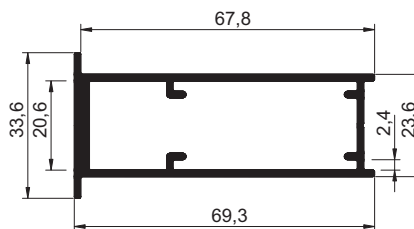

COMPATÍVEL · MONTAGEM

DES-1511

DES-1512

DES-1514

## DES-1512

TRAVESSA VIDRO DUPLO  
0,987 Kg/m

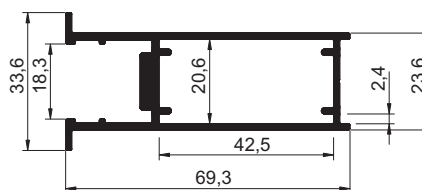
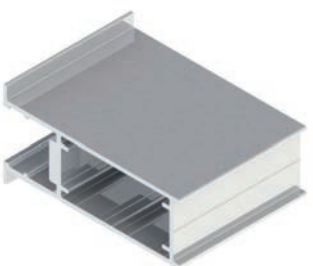

COMPATÍVEL · MONTAGEM

DES-1510

DES-1511

DES-1513

DES-1514

## DES-1513

TRILHO MÃO DE AMIGO  
0,278 Kg/m

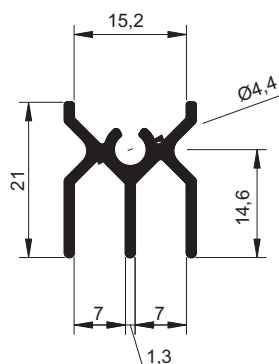
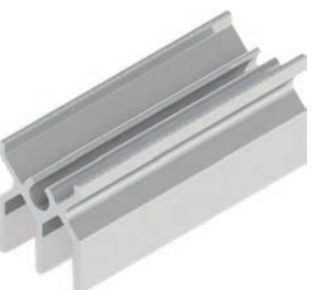

COMPATÍVEL · MONTAGEM

DES-1512

A ALUMICONTE reserva-se o direito de fazer modificações em qualquer informação escrita neste catálogo sem aviso prévio. Os desenhos aqui contidos possuem medidas teóricas de massa e tolerâncias dimensionais de acordo com a ABNT NBR-8116, podendo haver variações dessas informações no produto final.

## DES-1514

TRAVESSA DIVISÓRIA  
0,532 Kg/m

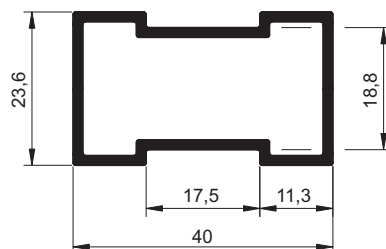

COMPATÍVEL · MONTAGEM

**DES-1510**

**DES-1511**

**DES-1512**

## DES-086

BARRA CHATA 25x3  
0,203 Kg/m



## DES-087

BARRA CHATA 35x3  
0,284 Kg/m

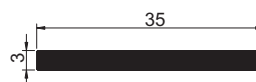
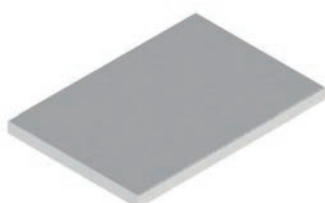

## DES-140

BARRA CHATA 44,5x9,5  
1,145 Kg/m

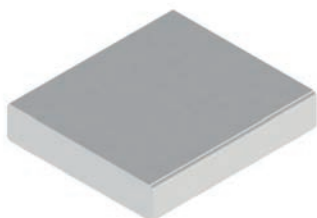

### DES-267

BARRA CHATA 3/4"x1/8"-19,05x3,18  
0,164 Kg/m

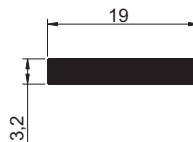
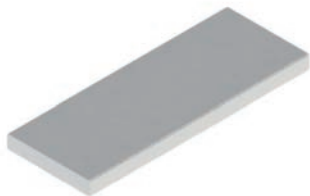

### DES-319

BARRA CHATA 16x3  
0,126 Kg/m

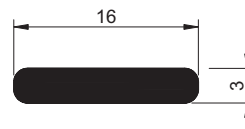

### DES-742

BARRA CHATA 1/4"x43  
0,740 Kg/m

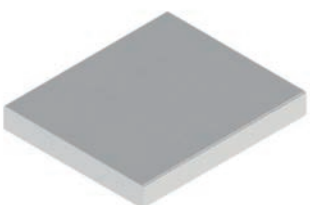

### DES-873

BARRA CHATA 38,1 X 4,76 mm  
0,491 Kg/m

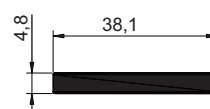
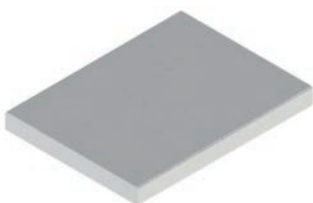

A ALUMICONTE reserva-se o direito de fazer modificações em qualquer informação escrita neste catálogo sem aviso prévio. Os desenhos aqui contidos possuem medidas teóricas de massa e tolerâncias dimensionais de acordo com a ABNT NBR-8116, podendo haver variações dessas informações no produto final.

## DES-1009

BARRA CHATA 4 3/4"x5/16"-120,65x7,94  
2,634 Kg/m

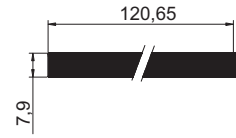
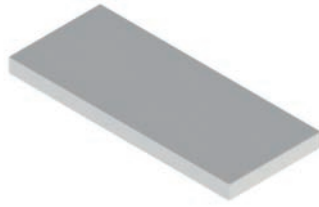

## BXT-482

BARRA CHATA 3/16"x5/8"  
0,207 Kg/m

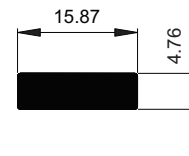
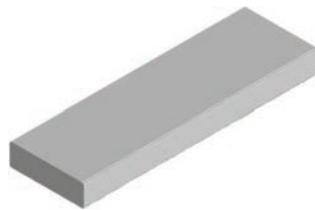

## BXT-483

BARRA CHATA 4x19mm  
0,207 Kg/m

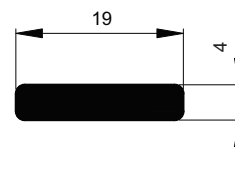
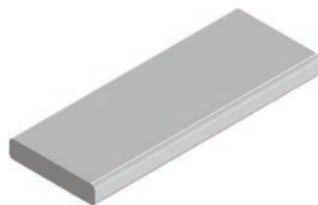

## BXT-484

BARRA CHATA 4x19mm  
0,284 Kg/m

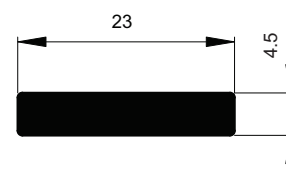
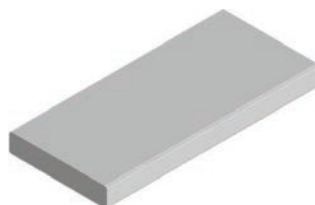

### BXT-485

BARRA CHATA 2,5x19mm  
0,130 Kg/m

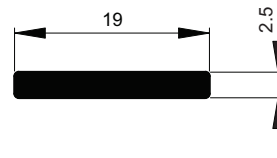

### DES-255

TUBO QUADRADO 1 1/2"x2  
0,783 Kg/m

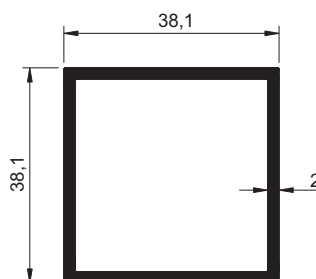

### DES-256

TUBO QUADRADO 1"x1,6  
0,408 Kg/m

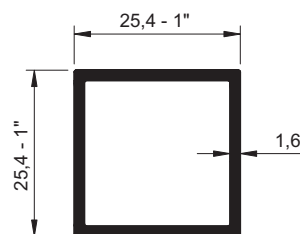

### DES-386

TUBO QUADRADO 1 1/2"x1,3  
0,519 Kg/m

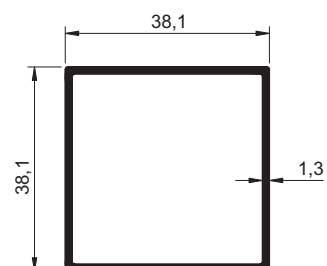

A ALUMICONTE reserva-se o direito de fazer modificações em qualquer informação escrita neste catálogo sem aviso prévio. Os desenhos aqui contidos possuem medidas teóricas de massa e tolerâncias dimensionais de acordo com a ABNT NBR-8116, podendo haver variações dessas informações no produto final.

### DES-602

TUBO QUADRADO 1/2"x1,5  
0,182 Kg/m

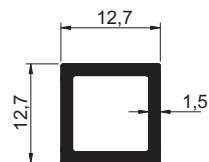

### DES-998

TUBO QUADRADO 1/2" -12,7  
0,148 Kg/m

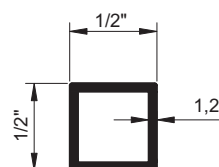

### DES-1026

TUBO QUADRADO 40x1,3  
0,545 Kg/m

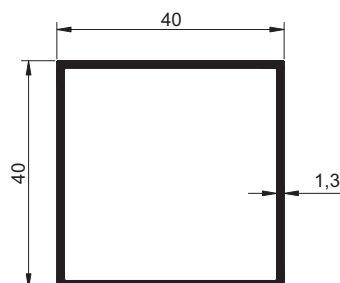
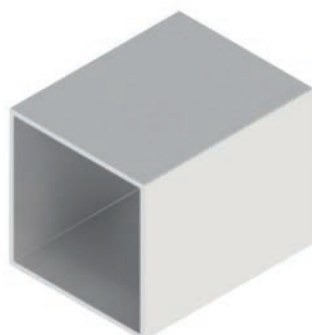

### DES-1040

TUBO QUADRADO 15x2,0  
0,282 Kg/m

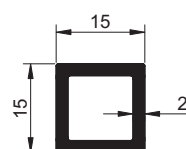



### BXT-496

RUBO RETANGULAR 50x13x1,3mm  
0,431 Kg/m

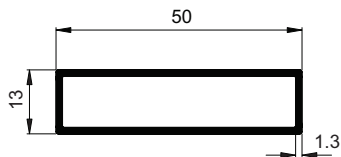
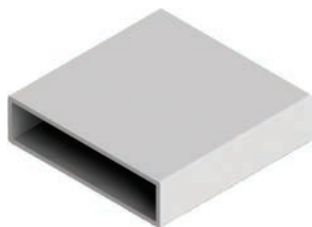

### DES-677

VERGALHÃO REDONDO 7/16"-Ø11,1  
0,263 Kg/m

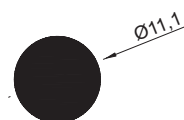

### DES-678

VERGALHÃO REDONDO 1/2" Ø12,7  
0,343 Kg/m

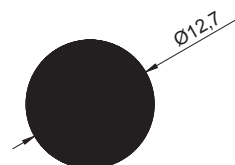

### DES-1104

ESTRUTURAL  
1,373 Kg/m

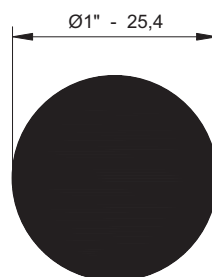

A ALUMICONTE reserva-se o direito de fazer modificações em qualquer informação escrita neste catálogo sem aviso prévio. Os desenhos aqui contidos possuem medidas teóricas de massa e tolerâncias dimensionais de acordo com a ABNT NBR-8116, podendo haver variações dessas informações no produto final.

## DES-151

CANTONEIRA ABA REFORÇADA 12x8

0,066 Kg/m

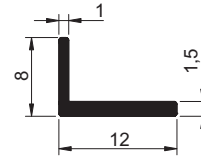

## DES-243

CANTONEIRA 5/8"x1,3

0,106 Kg/m

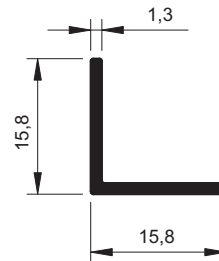

## DES-244

CANTONEIRA 3/4"x1,3

0,129 Kg/m

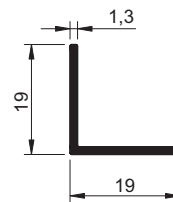

## ALU-043

CANTONEIRA

0,481 Kg/m

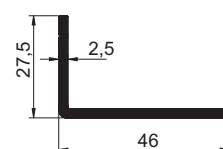

### ALU-044

CANTONEIRA  
0,861 Kg/m

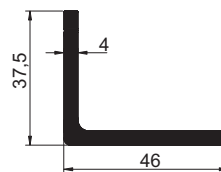

### BXT-498

CANTONEIRA 50,8X2mm  
0,548 Kg/m

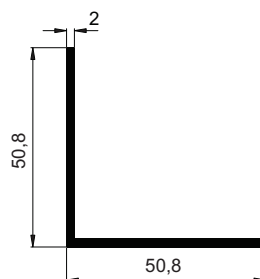

### DES-1458

CANTONEIRA 19 x 19mm  
0,117 Kg/m

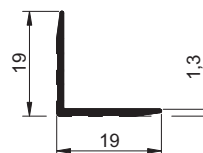
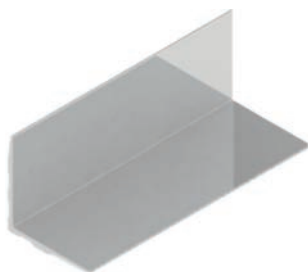

### DES-027D6

SUPORE LUMINÁRIA  
0,293 Kg/m

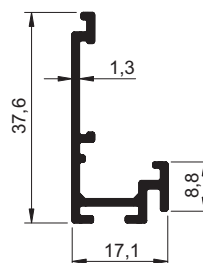

A ALUMICONTE reserva-se o direito de fazer modificações em qualquer informação escrita neste catálogo sem aviso prévio. Os desenhos aqui contidos possuem medidas teóricas de massa e tolerâncias dimensionais de acordo com a ABNT NBR-8116, podendo haver variações dessas informações no produto final.

## DES-083

CONECTOR MDF FUNDO movel

0,144 Kg/m

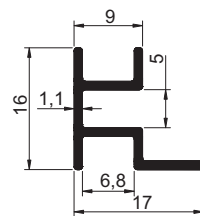

## DES-093

GUIA DE ENCAIXE VIDRO 10

0,227 Kg/m

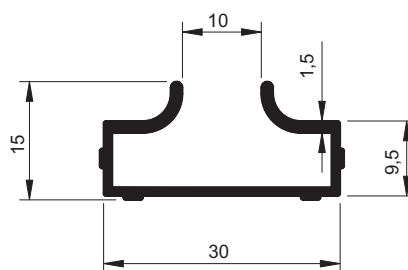

## DES-171

PERFIL "U" 29x14

0,218 Kg/m

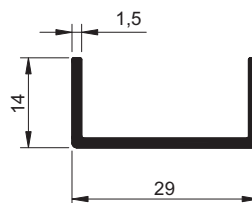
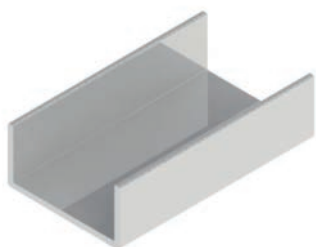

## DES-229

PERFIL "J" 15x20,6

0,204 Kg/m

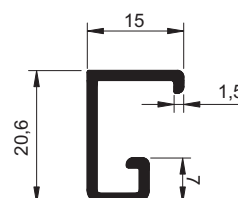

### DES-246

PERFIL "H" C/ REFORÇO CENTRAL 17x8,8  
0,169 Kg/m

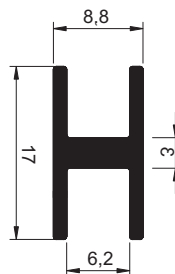

### DES-615

PERFIL "U" 20x35 MDF 15  
0,622 Kg/m

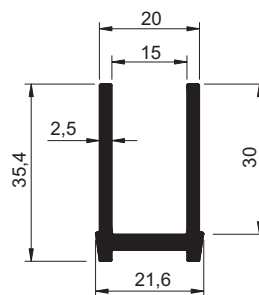
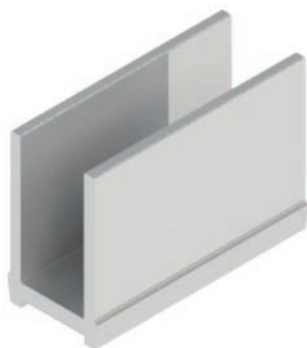

### DES-616

PERFIL "U" 24x36 MDF 18  
0,713 Kg/m

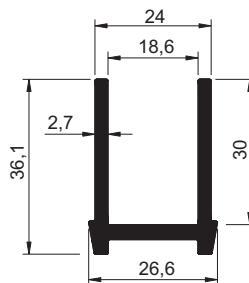
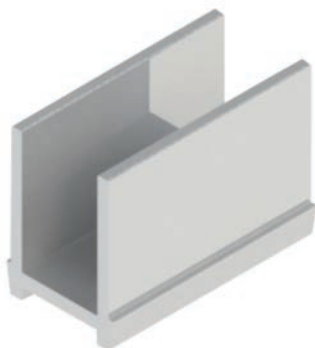

### DES-666

PERFIL "U" 30x29,3 C/ ALOJAMENTO VEDAÇÃO  
0,533 Kg/m

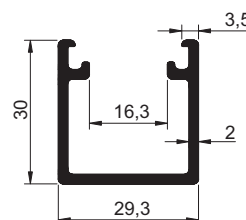

A ALUMICONTE reserva-se o direito de fazer modificações em qualquer informação escrita neste catálogo sem aviso prévio. Os desenhos aqui contidos possuem medidas teóricas de massa e tolerâncias dimensionais de acordo com a ABNT NBR-8116, podendo haver variações dessas informações no produto final.

### DES-670

CANTO VITRINE/EXPOSITOR  
0,564 Kg/m

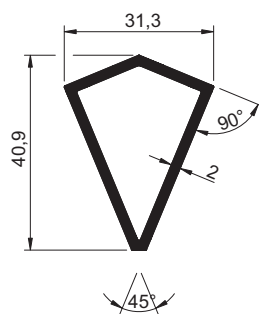
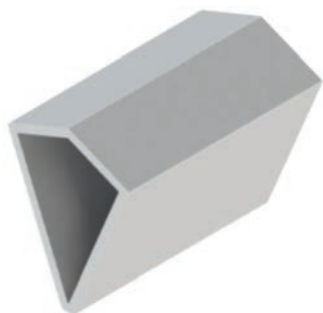

### DES-841

PERFIL "C" 9,5x6  
0,076 Kg/m

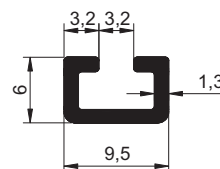

### DES-888

PERFIL "U" C/ OLHAL INTERNO  
0,292 Kg/m

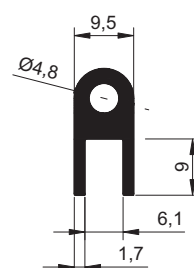

### DES-1083

GUIA SISTEMA MESA DESLIZANTE  
0,137 Kg/m

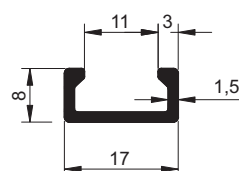

### DES-1270

PUXADOR ENCAIXE MDF/VIDRO

0,357 Kg/m

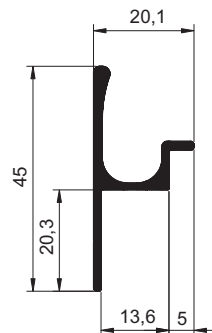

### DES-1281

ESTRUTURAL BOLEADO

0,966 Kg/m

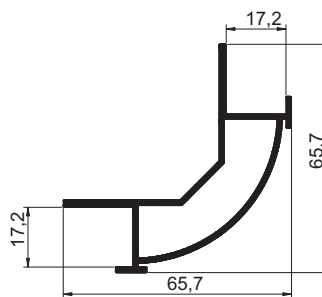

### DES-1290

ONDULADO 72 x 3,6 mm

0,291 Kg/m

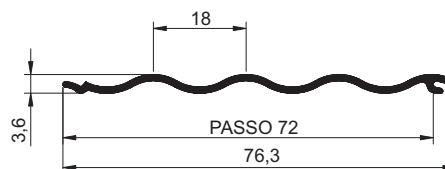

### DES-1407

QUADRO PELE VIDRO

0,293 Kg/m

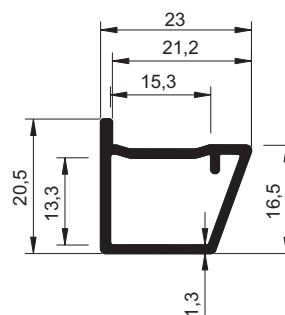

A ALUMICONTE reserva-se o direito de fazer modificações em qualquer informação escrita neste catálogo sem aviso prévio. Os desenhos aqui contidos possuem medidas teóricas de massa e tolerâncias dimensionais de acordo com a ABNT NBR-8116, podendo haver variações dessas informações no produto final.

## DES-1457

ENCAIXE 7mm  
0,196 Kg/m

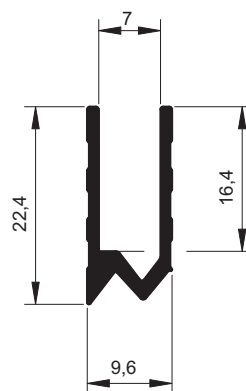

## DES-1477

MONTANTE TRASEIRO VITRINE  
0,952 Kg/m

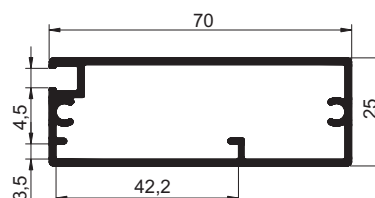

## DES-1478

MONTANTE FRONTAL VITRINE | LED  
0,989 Kg/m

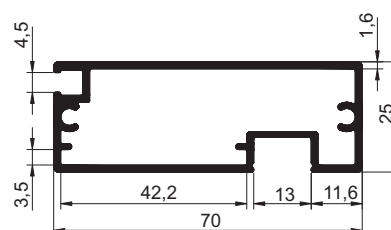
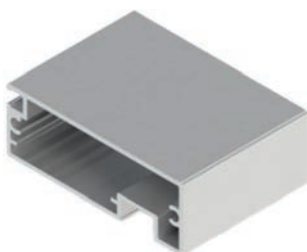

## DES-1479

MONTANTE CENTRAL VITRINE  
0,943 Kg/m

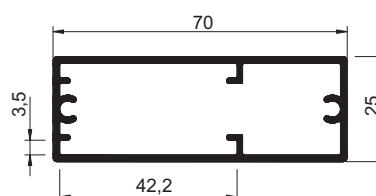
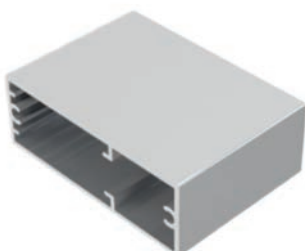



### DES-1480

MONTANTE CENTRAL VITRINE LED

0,991 Kg/m

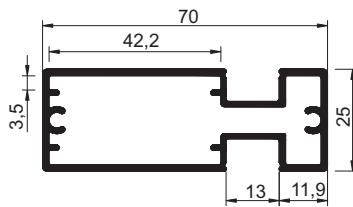
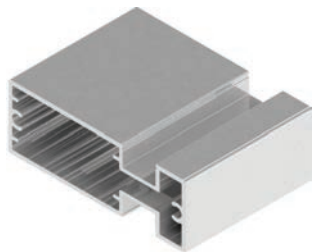

### DES-1487

QUADRO PRATELEIRA LED

0,573 Kg/m

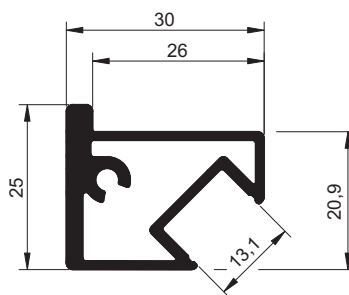

### DES-1488

QUADRO PRATELEIRA LED

0,515 Kg/m

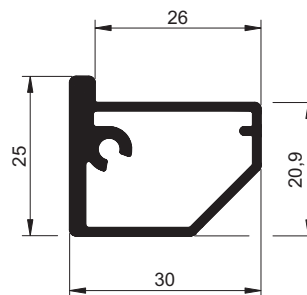

### DES-1409

QUADRO PRATELEIRA LED

0,470 Kg/m

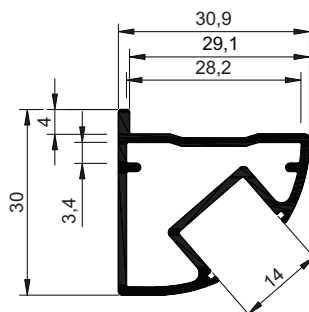

COMPATÍVEL · MONTAGEM

**DES-1410**

**DES-1411**

A ALUMICONTE reserva-se o direito de fazer modificações em qualquer informação escrita neste catálogo sem aviso prévio. Os desenhos aqui contidos possuem medidas teóricas de massa e tolerâncias dimensionais de acordo com a ABNT NBR-8116, podendo haver variações dessas informações no produto final.

## DES-1410

QUADRO PRATELEIRA

0,396 Kg/m

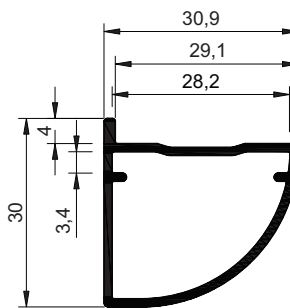

COMPATÍVEL · MONTAGEM

DES-1409

DES-1411

## DES-1411

QUADRO LATERAL PRATELEIRA

0,459 Kg/m

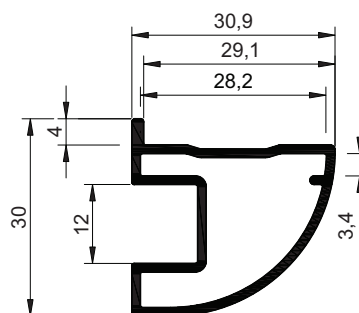

COMPATÍVEL · MONTAGEM

DES-1409

DES-1410

## DES-1515

TRILHO MÃO DE AMIGO

0,080 Kg/m

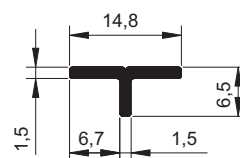

## DES-1516

TRAVESSA SUP/INF VIDRO DUPLO

0,851 Kg/m

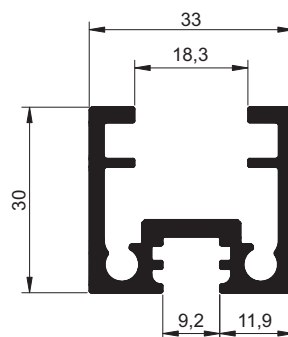

### DES-1517

MONTANTE VIDRO DUPLO

0,738 Kg/m

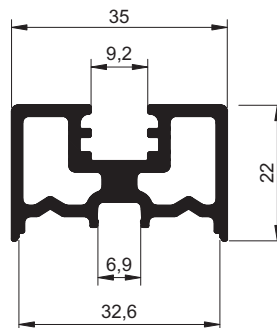
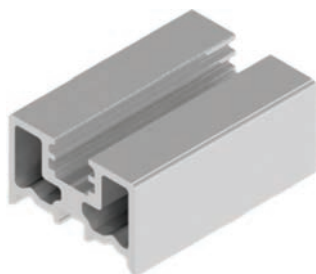

### DES-1518

CAPA MONTANTE

0,140 Kg/m

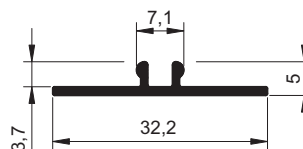
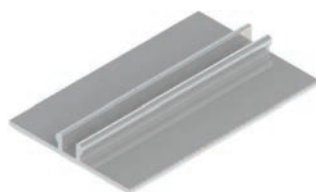

### DES-1519

TRAVESSA DIVISÓRIA

0,783 Kg/m

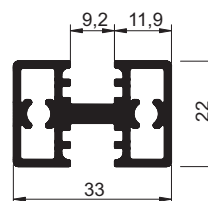
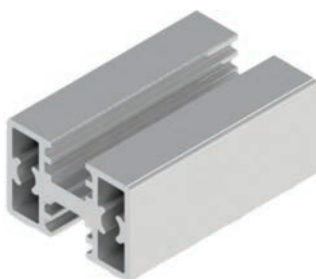

### DES-1253

COMPLEMENTO CAVA DUPLA 49x22

0,559 Kg/m

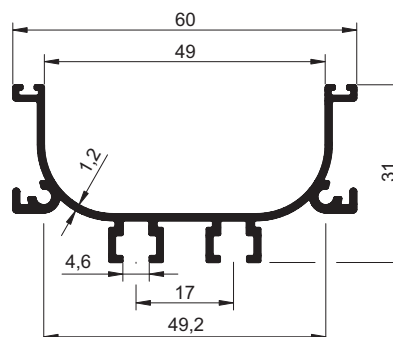
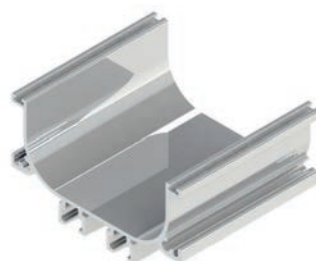

A ALUMICONTE reserva-se o direito de fazer modificações em qualquer informação escrita neste catálogo sem aviso prévio. Os desenhos aqui contidos possuem medidas teóricas de massa e tolerâncias dimensionais de acordo com a ABNT NBR-8116, podendo haver variações dessas informações no produto final.

## DES-1254

COMPLEMENTO CAVA SIMPLES 45x22,5  
0,452 Kg/m

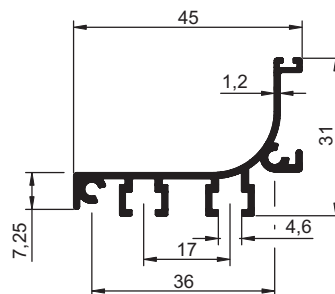

## DES-1255

COMPLEMENTO CAVA SIMPLES 57x20  
0,447 Kg/m

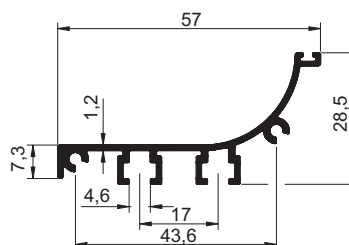
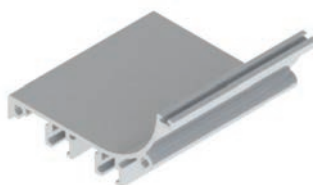

## DES-880

TUBO QUADRADO 38mm C/ OLHAL FIXAÇÃO  
0,928 Kg/m

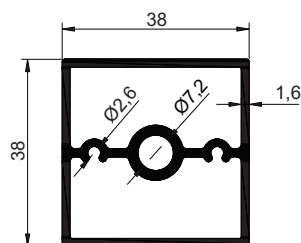
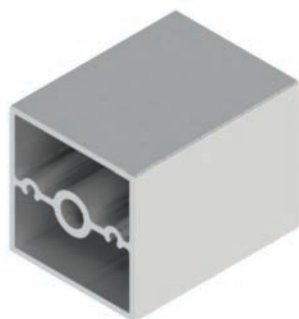

# TRILHOS PARA ESQUADRIAS DE MADEIRA

Perfis desenvolvidos especialmente para aplicação em esquadrias de madeira, contribuindo para seu desempenho e leveza de movimento

## ACABAMENTOS & CORES

### Natural

### Anodizado

Fosco | Bronze 1001 | 1002 | 1003 | Preto

### Jateado e Anodizado

Fosco | Bronze 1001 | 1002 | 1003 | Preto

### Escovado e Anodizado

Inox | Preto

### Pintura Eletrostática

## DES-006

TRILHO ESQUADRIAS MADEIRA  
0,181 Kg/m

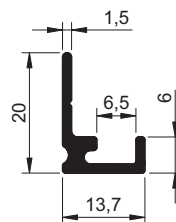
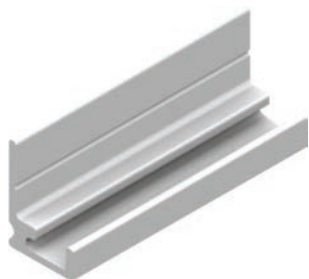

## DES-027

TRILHO ESQUADRIAS MADEIRA  
0,173 Kg/m

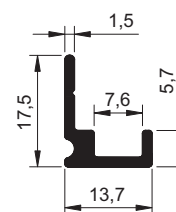

## DES-028

TRILHO ESQUADRIAS MADEIRA  
0,138 Kg/m

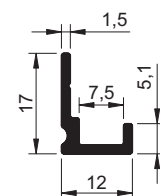

## DES-059

TRILHO ESQUADRIAS MADEIRA  
0,232 Kg/m

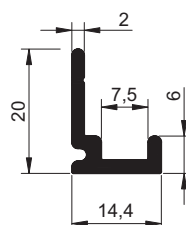

### DES-164

TRILHO ESQUADRIAS MADEIRA

0,265 Kg/m

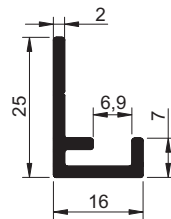
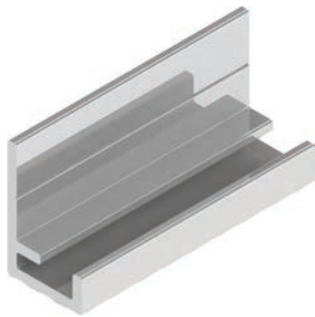

### DES-242

TRILHO LINEAR - ROLDANA CÔNCAVA

0,166 Kg/m

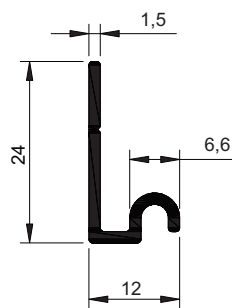

### DES-033

TRILHO ESQUADRIAS MADEIRA

0,792 Kg/m

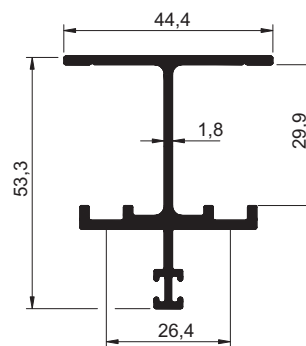
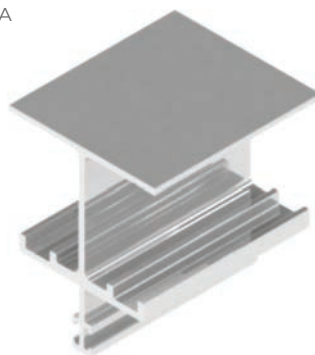

### DES-034

TRILHO ESQUADRIAS MADEIRA

0,542 Kg/m

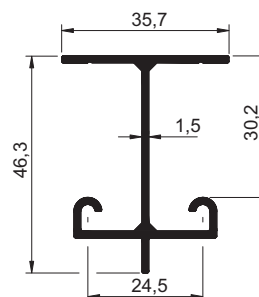
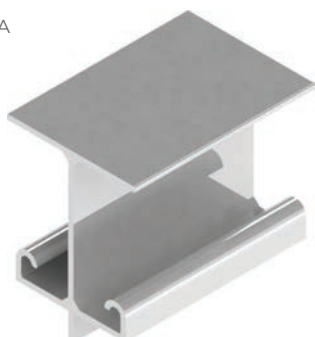

A ALUMICONTE reserva-se o direito de fazer modificações em qualquer informação escrita neste catálogo sem aviso prévio. Os desenhos aqui contidos possuem medidas teóricas de massa e tolerâncias dimensionais de acordo com a ABNT NBR-8116, podendo haver variações dessas informações no produto final.

## DES-040

TRILHO ESQUADRIAS MADEIRA

0,616 Kg/m

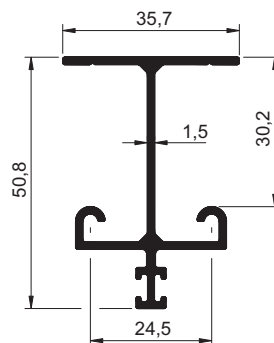

## DES-166

TRILHO SUPERIOR ESQUADRIAS MADEIRA

1,434 Kg/m

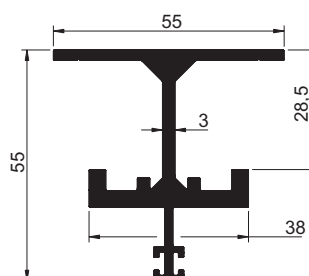
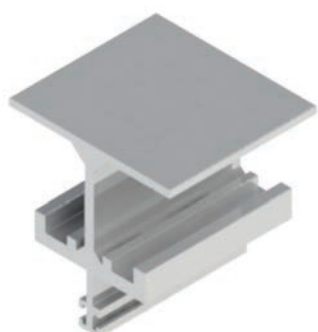

## DES-876

TRILHO ESQUADRIAS MADEIRA

0,647 Kg/m

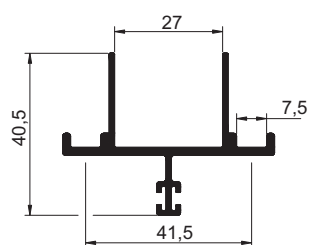

## DES-029

TRILHO ESQUADRIAS MADEIRA

0,179 Kg/m

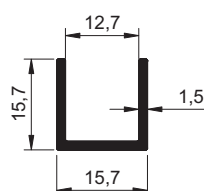

## DES-031

TRILHO ESQUADRIAS MADEIRA

0,140 Kg/m

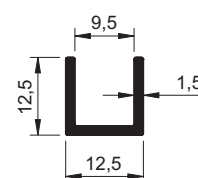



## NORMAS ABNT

A Associação Brasileira de Normas Técnicas (ABNT) é o órgão responsável pela normatização técnica no Brasil, fornecendo insumos ao desenvolvimento tecnológico brasileiro. Trata-se de uma entidade privada, sem fins lucrativos e de utilidade pública, fundada em 1940.

Todos os produtos desenvolvidos e produzidos pela Alumiconte contidos neste catálogo seguem rigorosamente, entre outras, as seguintes normas ABNT:

- **NBR 8116:** Alumínio e suas Ligas | Produtos Extrudados | Tolerâncias Dimensionais.
- **NBR 12609:** Alumínio e suas Ligas | Anodização para Fins Arquitetônicos | Requisitos.
- **NBR 14125:** Alumínio e suas Ligas | Tratamento de Superfícies | Revestimento Orgânico para Fins Arquitetônicos | Requisitos.



**ALUMICONTE**

COMPONENTES • PERFIS • PERSIANAS



ALUMICONTE

TEL. +55 (54)3447-4000

RUA CONDE DE PORTO ALEGRE, 1000 - CENTRO

CEP 95334-000 - VILA FLORES/RS - WWW.ALUMICONTE.COM.BR