

Linha Moveleira

CATÁLOGO GERAL



GRANDE COMO AS MINHAS IDEIAS

São
mais de:

RESPEITO AO MEIO AMBIENTE

Nos preocupamos com o meio ambiente e, entre nossos princípios básicos, está o gerenciamento ambiental.

COMPROMISSO TOTAL COM A QUALIDADE

Fundada em 1988, a Alumicone conta com amplo portfólio de componentes e persianas para esquadrias, além de perfis para a construção civil, setor moveleiro e industrial, dispondo de processo próprio de anodização e pintura eletrostática para acabamento dos produtos.

Destaca-se pela qualidade dos produtos e serviços prestados, resultado da dedicação em todas as etapas do processo produtivo e pela assistência técnica especializada que oferece aos clientes, elaborando soluções que se adaptam perfeitamente aos projetos.

35 anos
de experiência no setor

4.500
itens

24.000m²
de área fabril

A empresa propõe-se, como um dos principais requisitos, o atendimento às diretrizes e os compromissos ambientais gerados nas esferas municipal, estadual e federal. Neste aspecto, implantou em 1999 uma estação de tratamento de efluentes líquidos industriais com área construída de 600m², além de:

1. Priorizar a redução na geração de resíduos.
2. Implantar técnicas de tratamento e disposição com baixo consumo de energia e espaço físico.
3. Sempre que possível optar pelo reúso e/ou pela reciclagem.
4. Operar o processo produtivo maximizando as tecnologias limpas.
5. Gerenciar os resíduos, preservando assim, a qualidade ambiental e socioeconômica da comunidade na qual estamos inseridos.

São premissas básicas da Alumicone: atuar na melhoria contínua de nossos produtos e processos, seguindo normas nacionais e internacionais (ABNT - Associação Brasileira de Normas Técnicas, ISO 9001:2015 e ISO 14001:2015) sempre que aplicáveis, visando o atendimento das necessidades e expectativas dos nossos clientes e partes interessadas, além de estimular, motivar e capacitar os colaboradores a participarem e se comprometerem com os Programas de Qualidade em todos os níveis do processo, garantindo assim, produtos com alto padrão de qualidade e a satisfação dos clientes.



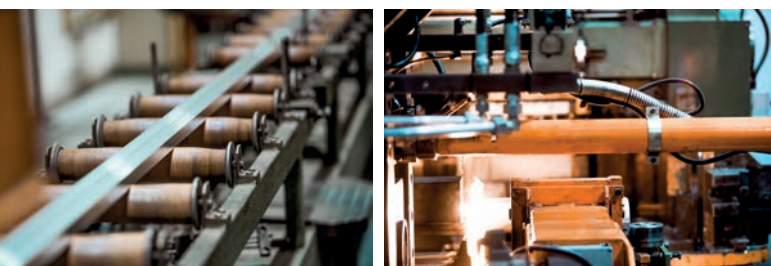

Saiba mais sobre **EXTRUSÃO DE ALUMÍNIO**

A extrusão é um processo de produção de componentes mecânicos de forma semicontínua, no qual o alumínio é forçado através de uma matriz, adquirindo assim a forma predeterminada de acordo com a necessidade. Perfis de alumínio são utilizados nos ramos de construção civil, indústria naval, aeroespacial, automobilística e moveleira.

Na **Alumiconte**, contamos com 3 grandes extrusoras de alumínio, com capacidade produtiva mensal de mais de 500.000kg, voltados a atender a construção civil, setor moveleiro e industrial.

CONSTRUÇÃO CIVIL

Perfis voltados para a produção de esquadrias, oferecemos ampla gama de produtos, atendendo de forma eficiente às necessidades do serralheiro, entregando alto padrão estético, de qualidade e funcionalidade.

INDÚSTRIA MOVELEIRA

Em nosso portfólio de itens voltados para indústria moveleira, você encontra mais de 600 produtos em linha, que atendem a inúmeras formas e aplicações.

PERFIS PERSONALIZADOS

Dispomos de setor de engenharia focado na busca pela solução ideal para cada projeto, produzindo perfis personalizados, de acordo com o design e necessidade do cliente.

PERFIL PUXADOR DE ENCAIXE

18 mm

CÓDIGO	P.	CÓDIGO	P.	CÓDIGO	P.	CÓDIGO	P.	CÓDIGO	P.
DES-009	12	DES-192	21	DES-314	19	DES-931	15	DES-1404	18
DES-022	20	DES-197	15	DES-337	20	DES-949	15	DES-1432	18
DES-074	12	DES-201	15	DES-385	14	DES-960	12	DES-1465	22
DES-089	13	DES-202	13	DES-404	17	DES-999	16	DES-1696	22
DES-094	21	DES-212	13	DES-611	20	DES-1063	16	DES-2167	23
DES-102	14	DES-224	17	DES-620	14	DES-1068	16		
DES-108	19	DES-264	12	DES-622	21	DES-1069	16		
DES-132	19	DES-266	20	DES-623	22	DES-1272	21		
DES-142	19	DES-275	13	DES-883	23	DES-1273	22		
DES-173	17	DES-305	18	DES-923	17	DES-1400	14		

PERFIL PUXADOR DE ENCAIXE

15 mm

CÓDIGO	P.	CÓDIGO	P.	CÓDIGO	P.	CÓDIGO	P.	CÓDIGO	P.
DES-162	27	DES-222	28	DES-284	26	DES-933	30	DES-1078	27
DES-194	28	DES-234	28	DES-312	27	DES-970	26	DES-1322	29
DES-213	25	DES-238	29	DES-339	25	DES-1011	28	DES-1401	27
DES-214	25	DES-265	29	DES-345	29	DES-1062	26	DES-1405	30
DES-221	30	DES-270	25	DES-621	26	DES-1077	27	DES-1431	30

PERFIL PUXADOR

CÓDIGO	P.	CÓDIGO	P.	CÓDIGO	P.	CÓDIGO	P.	CÓDIGO	P.
DES-043	31	DES-203	36	DES-833	34	DES-1251	33	DES-1423	40
DES-046	39	DES-232	42	DES-842	34	DES-1252	33	DES-1613	31
DES-063	39	DES-239	31	DES-872	41	DES-1278	37	DES-1614	32
DES-064	39	DES-296	35	DES-879	42	DES-1280	33	DES-1615	32
DES-090	40	DES-347	39	DES-881	40	DES-1299	38	DES-2184	33
DES-112	33	DES-353	42	DES-901	38	DES-1319	36	DES-2185	31
DES-144	34	DES-395	35	DES-908	35	DES-1324	38	DES-2193	33
DES-145	35	DES-519	31	DES-909	36	DES-1329	36		
DES-148	37	DES-680	41	DES-976	42	DES-1332	36		
DES-149	37	DES-695	34	DES-993	37	DES-1420	32		
DES-175	41	DES-826	41	DES-1013	38	DES-1421	32		

PERFIL QUADRO DE VIDRO

CÓDIGO	P.	CÓDIGO	P.	CÓDIGO	P.	CÓDIGO	P.	CÓDIGO	P.
DES-001	44	DES-084	46	DES-523	47	DES-1093	59	DES-1451	57
DES-002	44	DES-128	55	DES-530	48	DES-1226	58	DES-1452	50
DES-007	44	DES-129	52	DES-550	48	DES-1250	49	DES-1490	51
DES-008	44	DES-130	52	DES-691	48	DES-1264	50	DES-1492	58
DES-010	45	DES-133	46	DES-832	45	DES-1279	55	DES-1609	51
DES-014	45	DES-147	55	DES-875	48	DES-1291	53	DES-1612	51
DES-015	54	DES-178	53	DES-902	49	DES-1300	57	DES-1789	57
DES-016	52	DES-198	46	DES-912	58	DES-1301	57	DES-1934	52
DES-017	54	DES-226	55	DES-929	49	DES-1321	56	DES-2074	59
DES-018	54	DES-233	46	DES-951	56	DES-1326	50	DES-2075	59
DES-019	53	DES-297	47	DES-953	56	DES-1328	51		
DES-060	52	DES-300	53	DES-1042	59	DES-1402	50		
DES-062	45	DES-311	47	DES-1060	49	DES-1407	58		
DES-073	54	DES-318	47	DES-1073	56	DES-1414	57		

PERFIL QUADRO DE VIDRO COM PUXADOR

CÓDIGO	P.	CÓDIGO	P.	CÓDIGO	P.	CÓDIGO	P.	CÓDIGO	P.
DES-011	66	DES-227	69	DES-692	64	DES-1061	61	DES-1408	70
DES-012	65	DES-279	67	DES-730	60	DES-1074	70	DES-1419	63
DES-026	66	DES-282	61	DES-877	64	DES-1094	68	DES-1489	64
DES-076	63	DES-301	68	DES-897	65	DES-1225	69	DES-1491	70
DES-078	67	DES-313	64	DES-930	62	DES-1227	69	DES-1610	63
DES-158	63	DES-320	65	DES-940	65	DES-1228	70	DES-1697	70
DES-187	67	DES-362	68	DES-950	62	DES-1265	66	DES-2192	64
DES-193	67	DES-370	60	DES-1012	66	DES-1268	62		
DES-204	60	DES-551	60	DES-1014	62	DES-1271	70		
DES-225	69	DES-690	61	DES-1043	68	DES-1403	61		

TRAVESSA QUADRO DE VIDRO

CÓDIGO	P.	CÓDIGO	P.	CÓDIGO	P.	CÓDIGO	P.	CÓDIGO	P.
BXT-505	72	DES-247	71	DES-952	71	DES-1044	73	DES-1453	71
DES-077	72	DES-856	73	DES-1016	73	DES-1075	72		
DES-168	71	DES-868	73	DES-1017	72	DES-1297	72		

PERFIL TRILHO DE CORRER

CÓDIGO	P.	CÓDIGO	P.	CÓDIGO	P.	CÓDIGO	P.	CÓDIGO	P.
DES-032	81	DES-156	81	DES-287	82	DES-601	84	DES-1274	85
DES-035	78	DES-167	77	DES-340	82	DES-813	84	DES-1433	79
DES-036	76	DES-169	82	DES-379	82	DES-844	84	DES-1434	83
DES-037	76	DES-200	76	DES-380	79	DES-886	78		
DES-038	80	DES-261	77	DES-390	81	DES-906	84		
DES-039	78	DES-262	77	DES-480	83	DES-944	79		
DES-044	76	DES-269	81	DES-511	83	DES-980	80		
DES-050A	82	DES-273	80	DES-524	83	DES-992	80		

SUPERIOR

PERFIL TRILHO DE CORRER

CÓDIGO	P.	CÓDIGO	P.	CÓDIGO	P.	CÓDIGO	P.	CÓDIGO	P.
DES-041	86	DES-058	90	DES-294	87	DES-603	89	DES-907	90
DES-042	87	DES-113	87	DES-309	88	DES-820	88	DES-1275	90
DES-049	90	DES-155	86	DES-315	86	DES-824	90	DES-1284	88
DES-051	89	DES-188	88	DES-344	89	DES-836	90		
DES-055	86	DES-228	89	DES-512	87	DES-843	90		

INFERIOR

PERFIL TESTEIRA

CÓDIGO	P.	CÓDIGO	P.	CÓDIGO	P.	CÓDIGO	P.	CÓDIGO	P.
DES-143	92	DES-205	94	DES-248	92	DES-293	94	DES-884	94
DES-150	94	DES-240	94	DES-249	93	DES-693	92	DES-1620	93
DES-165	93	DES-241	94	DES-292	92	DES-694	93		

PERFIL MONTANTE PUXADOR

CÓDIGO	P.	CÓDIGO	P.	CÓDIGO	P.	CÓDIGO	P.	CÓDIGO	P.
DES-104	95	DES-258	98	DES-291	96	DES-810	97	DES-846	98
DES-121	96	DES-259	96	DES-307	95	DES-812	98	DES-874	98
DES-127	95	DES-260	98	DES-334	96	DES-819	97		
DES-257	98	DES-290	95	DES-675	97	DES-822	97		

PERFIL PARA DIVISÓRIAS

CÓDIGO	P.	CÓDIGO	P.	CÓDIGO	P.	CÓDIGO	P.	CÓDIGO	P.
DES-302	99	DES-596	100	DES-599	100				
DES-303	99	DES-597	101	DES-600	100				
DES-304	99	DES-598	101	DES-799	101				

PERFIL VITRINE

CÓDIGO	P.	CÓDIGO	P.	CÓDIGO	P.	CÓDIGO	P.	CÓDIGO	P.
DES-075	102	DES-671	105	DES-740	105	DES-987	103	DES-1413	104
DES-335	102	DES-672	105	DES-741	105	DES-988	104	DES-1445	104
DES-336	102	DES-673	105	DES-894	103	DES-1289	104		
DES-400	103	DES-674	105	DES-932	103	DES-1412	104		

PERFIL PARA PAINEL MOVIE

CÓDIGO	P.	CÓDIGO	P.	CÓDIGO	P.	CÓDIGO	P.	CÓDIGO	P.
DES-851	107	DES-852	107	DES-1298	107	DES-1303	107		

PERFIS DIVERSOS

CÓDIGO	P.	CÓDIGO	P.	CÓDIGO	P.	CÓDIGO	P.	CÓDIGO	P.
ALU-043	123	DES-098	111	DES-387	109	DES-1270	128	DES-1510	116
ALU-044	124	DES-099	111	DES-602	121	DES-1276	112	DES-1511	110
ALV-2511	133	DES-100	110	DES-615	126	DES-1277	111	DES-1512	116
ALV-2512	133	DES-140	117	DES-616	126	DES-1281	128	DES-1514	117
ALV-2513	133	DES-151	123	DES-666	126	DES-1290	128	DES-1515	131
BXT-482	119	DES-157	109	DES-670	127	DES-1295	115	DES-1516	134
BXT-483	119	DES-161	109	DES-677	122	DES-1302	116	DES-1517	134
BXT-484	119	DES-163	110	DES-678	122	DES-1304	112	DES-1518	134
BXT-485	120	DES-171	125	DES-742	118	DES-1409	130	DES-1519	134
BXT-496	122	DES-181	111	DES-841	127	DES-1410	131	DES-1526	134
BXT-497	114	DES-229	125	DES-873	118	DES-1411	131	DES-1721	115
BXT-498	124	DES-243	123	DES-880	132	DES-1443	112	DES-1722	115
BXT-499	114	DES-244	123	DES-888	127	DES-1444	113	DES-1784	115
BXT-500	114	DES-246	126	DES-998	121	DES-1455	114	DES-1816	113
DES-027D6	124	DES-255	120	DES-1009	119	DES-1457	129	DES-1899	109
DES-052	109	DES-256	120	DES-1026	121	DES-1458	124	DES-2089	126
DES-079	112	DES-267	118	DES-1040	121	DES-1477	129	DES-2090	126
DES-083	125	DES-271	110	DES-1083	127	DES-1478	129		
DES-086	117	DES-289	113	DES-1104	122	DES-1479	129		
DES-087	117	DES-319	118	DES-1253	131	DES-1480	130		
DES-093	125	DES-342	113	DES-1254	132	DES-1487	130		
DES-097	113	DES-386	120	DES-1255	132	DES-1488	130		

ALUMICONTE ARMO

CÓDIGO	P.	CÓDIGO	P.	CÓDIGO	P.	CÓDIGO	P.	CÓDIGO	P.
ARM-062	136	ARM-530	136						
ARM-198	136								
ARM-204	136								

PERFIL ESQUADRIA DE MADEIRA

CÓDIGO	P.	CÓDIGO	P.	CÓDIGO	P.	CÓDIGO	P.	CÓDIGO	P.
DES-006	138	DES-029	140	DES-034	139	DES-164	139	DES-876	140
DES-027	138	DES-031	140	DES-040	140	DES-166	140		
DES-028	138	DES-033	139	DES-059	138	DES-242	139		

ALUMICONTE ÍSIS

CÓDIGO	P.	CÓDIGO	P.	CÓDIGO	P.	CÓDIGO	P.	CÓDIGO	P.
CA-060	143	DES-1481	143	DES-1970	144	DES-2076	143		
DES-1293	143	DES-1482	143	DES-1971	144	DES-2077	144		
DES-1294	143	DES-1483	143	DES-1972	144	RA-050	143		
DES-1295	143	DES-1969	144	DES-1998	144				

CÓDIGO	P.	CÓDIGO	P.	CÓDIGO	P.	CÓDIGO	P.	CÓDIGO	P.
ALU-043	123	DES-040	140	DES-143	92	DES-232	42	DES-309	88
ALU-044	124	DES-041	86	DES-144	34	DES-233	46	DES-311	47
ALV-2511	133	DES-042	87	DES-145	35	DES-234	28	DES-312	27
ALV-2512	133	DES-043	31	DES-147	55	DES-238	29	DES-313	64
ALV-2513	133	DES-044	76	DES-148	37	DES-239	31	DES-314	19
ARM-062	136	DES-046	39	DES-149	37	DES-240	94	DES-315	86
ARM-198	136	DES-049	90	DES-150	94	DES-241	94	DES-318	47
ARM-204	136	DES-050A	82	DES-151	123	DES-242	139	DES-319	118
ARM-530	136	DES-051	89	DES-155	86	DES-243	123	DES-320	65
BXT-482	119	DES-052	109	DES-156	81	DES-244	123	DES-334	96
BXT-483	119	DES-055	86	DES-157	109	DES-246	126	DES-335	102
BXT-484	119	DES-058	90	DES-158	63	DES-247	71	DES-336	102
BXT-485	120	DES-059	138	DES-161	109	DES-248	92	DES-337	20
BXT-496	122	DES-060	52	DES-162	27	DES-249	93	DES-339	25
BXT-497	114	DES-062	45	DES-163	110	DES-255	120	DES-340	82
BXT-498	124	DES-063	39	DES-164	139	DES-256	120	DES-342	113
BXT-499	114	DES-064	39	DES-165	93	DES-257	98	DES-344	89
BXT-500	114	DES-073	54	DES-166	140	DES-258	98	DES-345	29
BXT-505	72	DES-074	12	DES-167	77	DES-259	96	DES-347	39
CA-060	143	DES-075	102	DES-168	71	DES-260	98	DES-353	42
DES-001	44	DES-076	63	DES-169	82	DES-261	77	DES-362	68
DES-002	44	DES-077	72	DES-171	125	DES-262	77	DES-370	60
DES-006	138	DES-078	67	DES-173	17	DES-264	12	DES-379	82
DES-007	44	DES-079	112	DES-175	41	DES-265	29	DES-380	79
DES-008	44	DES-083	125	DES-178	53	DES-266	20	DES-385	14
DES-009	12	DES-084	46	DES-181	111	DES-267	118	DES-386	120
DES-010	45	DES-086	117	DES-187	67	DES-269	81	DES-387	109
DES-011	66	DES-087	117	DES-188	88	DES-270	25	DES-390	81
DES-012	65	DES-089	13	DES-192	21	DES-271	110	DES-395	35
DES-014	45	DES-090	40	DES-193	67	DES-273	80	DES-400	103
DES-015	54	DES-093	125	DES-194	28	DES-275	13	DES-404	17
DES-016	52	DES-094	21	DES-197	15	DES-279	67	DES-480	83
DES-017	54	DES-097	113	DES-198	46	DES-282	61	DES-511	83
DES-018	54	DES-098	111	DES-200	76	DES-284	26	DES-512	87
DES-019	53	DES-099	111	DES-201	15	DES-287	82	DES-519	31
DES-022	20	DES-100	110	DES-202	13	DES-289	113	DES-523	47
DES-026	66	DES-102	14	DES-203	36	DES-290	95	DES-524	83
DES-027	138	DES-104	95	DES-204	60	DES-291	96	DES-530	48
DES-027D6	124	DES-108	19	DES-205	94	DES-292	92	DES-550	48
DES-028	138	DES-112	33	DES-212	13	DES-293	94	DES-551	60
DES-029	140	DES-113	87	DES-213	25	DES-294	87	DES-596	100
DES-031	140	DES-121	96	DES-214	25	DES-296	35	DES-597	101
DES-032	81	DES-127	95	DES-221	30	DES-297	47	DES-598	101
DES-033	139	DES-128	55	DES-222	28	DES-300	53	DES-599	100
DES-034	139	DES-129	52	DES-224	17	DES-301	68	DES-600	100
DES-035	78	DES-130	52	DES-225	69	DES-302	99	DES-601	84
DES-036	76	DES-132	19	DES-226	55	DES-303	99	DES-602	121
DES-037	76	DES-133	46	DES-227	69	DES-304	99	DES-603	89
DES-038	80	DES-140	117	DES-228	89	DES-305	18	DES-611	20
DES-039	78	DES-142	19	DES-229	125	DES-307	95	DES-615	126

CÓDIGO	P.	CÓDIGO	P.	CÓDIGO	P.	CÓDIGO	P.	CÓDIGO	P.
DES-616	126	DES-877	64	DES-1044	73	DES-1300	57	DES-1483	143
DES-620	14	DES-879	42	DES-1060	49	DES-1301	57	DES-1487	130
DES-621	26	DES-880	132	DES-1061	61	DES-1302	116	DES-1488	130
DES-622	21	DES-881	40	DES-1062	26	DES-1303	107	DES-1489	64
DES-623	22	DES-883	23	DES-1063	16	DES-1304	112	DES-1490	51
DES-666	126	DES-884	94	DES-1068	16	DES-1319	36	DES-1491	70
DES-670	127	DES-886	78	DES-1069	16	DES-1321	56	DES-1492	58
DES-671	105	DES-888	127	DES-1073	56	DES-1322	29	DES-1510	116
DES-672	105	DES-894	103	DES-1074	70	DES-1324	38	DES-1511	110
DES-673	105	DES-897	65	DES-1075	72	DES-1326	50	DES-1512	116
DES-674	105	DES-901	38	DES-1077	27	DES-1328	51	DES-1514	117
DES-675	97	DES-902	49	DES-1078	27	DES-1329	36	DES-1515	131
DES-677	122	DES-906	84	DES-1083	127	DES-1332	36	DES-1516	134
DES-678	122	DES-907	90	DES-1093	59	DES-1400	14	DES-1517	134
DES-680	41	DES-908	35	DES-1094	68	DES-1401	27	DES-1518	134
DES-690	61	DES-909	36	DES-1104	122	DES-1402	50	DES-1519	134
DES-691	48	DES-912	58	DES-1225	69	DES-1403	61	DES-1526	134
DES-692	64	DES-923	17	DES-1226	58	DES-1404	18	DES-1609	51
DES-693	92	DES-929	49	DES-1227	69	DES-1405	30	DES-1610	63
DES-694	93	DES-930	62	DES-1228	70	DES-1407	58	DES-1612	51
DES-695	34	DES-931	15	DES-1250	49	DES-1408	70	DES-1613	31
DES-730	60	DES-932	103	DES-1251	33	DES-1409	130	DES-1614	32
DES-740	105	DES-933	30	DES-1252	33	DES-1410	131	DES-1615	32
DES-741	105	DES-940	65	DES-1253	131	DES-1411	131	DES-1620	93
DES-742	118	DES-944	79	DES-1254	132	DES-1412	104	DES-1696	22
DES-799	101	DES-949	15	DES-1255	132	DES-1413	104	DES-1697	70
DES-810	97	DES-950	62	DES-1264	50	DES-1414	57	DES-1721	115
DES-812	98	DES-951	56	DES-1265	66	DES-1419	63	DES-1722	115
DES-813	84	DES-952	71	DES-1268	62	DES-1420	32	DES-1784	115
DES-819	97	DES-953	56	DES-1270	128	DES-1421	32	DES-1789	57
DES-820	88	DES-960	12	DES-1271	70	DES-1423	40	DES-1816	113
DES-822	97	DES-970	26	DES-1272	21	DES-1431	30	DES-1899	109
DES-824	90	DES-976	42	DES-1273	22	DES-1432	18	DES-1934	52
DES-826	41	DES-980	80	DES-1274	85	DES-1433	79	DES-1969	144
DES-832	45	DES-987	103	DES-1275	90	DES-1434	83	DES-1970	144
DES-833	34	DES-988	104	DES-1276	112	DES-1443	112	DES-1971	144
DES-836	90	DES-992	80	DES-1277	111	DES-1444	113	DES-1972	144
DES-841	127	DES-993	37	DES-1278	37	DES-1445	104	DES-1998	144
DES-842	34	DES-998	121	DES-1279	55	DES-1451	57	DES-2074	59
DES-843	90	DES-999	16	DES-1280	33	DES-1452	50	DES-2075	59
DES-844	84	DES-1009	119	DES-1281	128	DES-1453	71	DES-2076	143
DES-846	98	DES-1011	28	DES-1284	88	DES-1455	114	DES-2077	144
DES-851	107	DES-1012	66	DES-1289	104	DES-1457	129	DES-2089	126
DES-852	107	DES-1013	38	DES-1290	128	DES-1458	124	DES-2090	126
DES-856	73	DES-1014	62	DES-1291	53	DES-1465	22	DES-2167	23
DES-868	73	DES-1016	73	DES-1293	143	DES-1477	129	DES-2184	33
DES-872	41	DES-1017	72	DES-1294	143	DES-1478	129	DES-2185	31
DES-873	118	DES-1026	121	DES-1295	115	DES-1479	129	DES-2192	64
DES-874	98	DES-1040	121	DES-1297	72	DES-1480	130	DES-2193	33
DES-875	48	DES-1042	59	DES-1298	107	DES-1481	143	RA-050	143
DES-876	140	DES-1043	68	DES-1299	38	DES-1482	143		



ACABAMENTOS & CORES

LANÇAMENTO!

ESCOVADO

Grande tendência do design de interiores, o alumínio anodizado e escovado da Alumicone veio para agregar ainda mais requinte e diferenciação aos seus ambientes.

Antes de ser anodizado, o perfil é submetido ao processo de escovação, que confere ao produto uma superfície com textura elegante e sofisticada.

CORES

Bronze 1003	Inox
Bronze 1002	Preto
Bronze 1001	Fosco

JATEAMENTO

A Alumicone conta com um grande diferencial no mercado quando o assunto é alumínio jateado, pois o nosso processo é mecânico, ou seja, acontece a partir do contato entre microesferas e o perfil, resultando em uma superfície de aspecto aveludado e sem quaisquer marcas.

A BASE PERFEITA PARA POSTERIOR ANODIZAÇÃO. Juntos, transformam o alumínio em um elemento essencial para o design do projeto.

ANODIZAÇÃO

A anodização é um processo eletrolítico que promove o preenchimento dos poros do alumínio e a formação de uma camada, de forma controlada e uniforme, de óxido em sua superfície. Por isso, podemos considerar a anodização uma fusão entre cor e material, resultando em um acabamento extremamente durável.

Este é um dos processos mais utilizados em perfis para o setor moveleiro, que ganha ainda mais beleza quando combinado à escovação ou jateamento.



Bronze 1003 Bronze 1002 Bronze 1001 Preto Fosco

PINTURA ELETROSTÁTICA

Perfeição de cobertura e acabamento são diferenciais da pintura eletrostática, além da resistência à abrasão e corrosão, bem como sua durabilidade perante exposição à intempéries (raios solares, calor, frio e umidade).

Este processo confere ao produto uma superfície lisa e de fácil higienização, combinados à alta durabilidade e aspecto impecável.



Branco Brilho Branco Fosco Preto Órion Preto Fosco Cinza 7037

LANÇAMENTO!

ALUMICONTE MADLOR

A leveza dos amadeirados com processo de sublimação interno

A **Alumiconte Madlor** é uma nova linha de acabamentos amadeirados, com um processo de sublimação completo realizado internamente na Alumiconte.

- Único sistema no mundo a oferecer 10 anos de garantia na combinação de base + filme, além de contar com certificações Qualicoat e Qualideco.

- Conta com Test in Flórida, que garante a eficiência do acabamento.

- Tinta à base de PU, a mais eficiente do mercado para processo de sublimação.

- Acabamento perfeito, abrangendo todas as regiões da geometria do perfil.

- Variedade de acabamentos para todos os Perfis de Construção Civil e Moveleiro da Alumiconte.

Uma nova proposta que irá trazer mais beleza e sofisticação aos seus projetos.



Uma grande variedade de acabamentos estão sendo desenvolvidos, dentre eles, 6 já estão disponíveis em nosso catálogo:



Madlor Castanha Café



Madlor Castanha Sépia



Madlor Cerejeira Marrom



Madlor Carvalho Marrom



Madlor Pinus Dourado



Madlor Pinus Marrom

Obs.: devido à impressão, podem ocorrer variações de tonalidade entre as amostras de cores do catálogo e produto físico.

PERFIL PUXADOR DE ENCAIXE

Com função de puxador, são voltados para aplicação em portas, gavetas e demais peças que contam com o movimento de abrir/fechar.



DES-009

PUXADOR ENCAIXE - MDF 18 mm
0,336 Kg/m

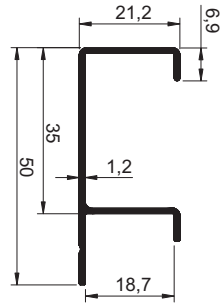

DES-264

PUXADOR ENCAIXE - MDF 18mm
0,367 Kg/m

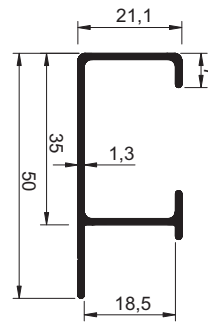

DES-960

PUXADOR ENCAIXE - MDF 18mm
0,319 Kg/m

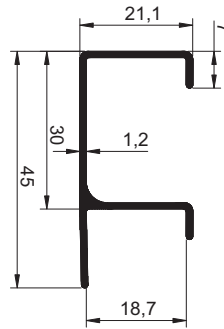

DES-074

PUXADOR ENCAIXE - MDF 18 mm
0,446 Kg/m

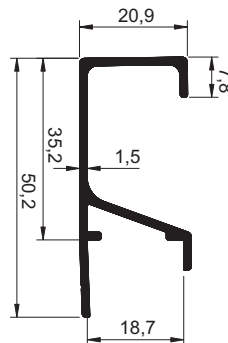

A ALUMICONTE reserva-se o direito de fazer modificações em qualquer informação escrita neste catálogo sem aviso prévio. Os desenhos aqui contidos possuem medidas teóricas de massa e tolerâncias dimensionais de acordo com a ABNT NBR-8116, podendo haver variações dessas informações no produto final.

DES-202

PUXADOR ENCAIXE - MDF 18mm
0,517 Kg/m

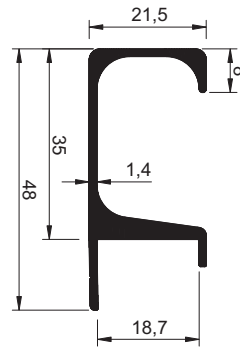

DES-212

PUXADOR ENCAIXE - MDF 18 mm
0,419 Kg/m

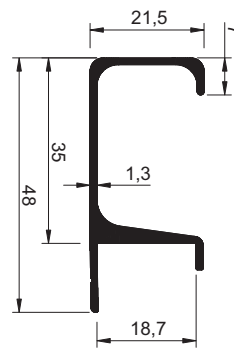

DES-275

PUXADOR ENCAIXE - MDF 18mm
0,434 Kg/m

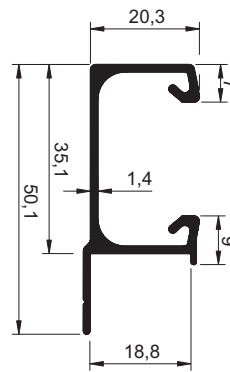

PONTEIRAS COMPATÍVEIS
BRANCO | BRONZE | CROMO
FOSCO | INOX | **PRETO**

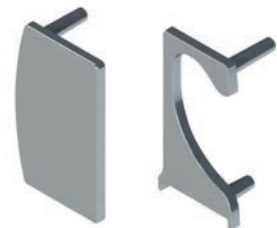

DES-089

PUXADOR ENCAIXE - MDF 18mm
0,461 Kg/m

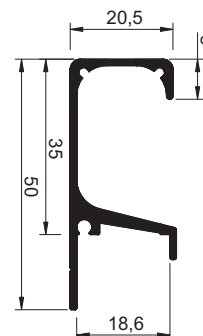

DES-385

PUXADOR ENCAIXE - MDF 18 mm

0,469 Kg/m

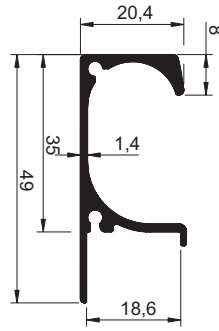

PONTEIRA COMPATÍVEL

BRANCO | BRONZE | CROMO

FOSCO | INOX | PRETO



DES-620

PUXADOR ENCAIXE - MDF 18 mm

0,461 Kg/m

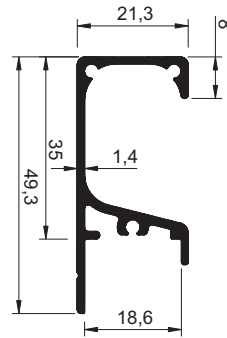

PONTEIRAS COMPATÍVEIS

BRANCO | BRONZE | CROMO

FOSCO | INOX | PRETO

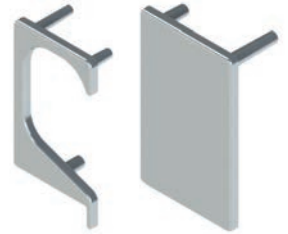

DES-102

PUXADOR ENCAIXE - MDF 18 mm

0,423 Kg/m

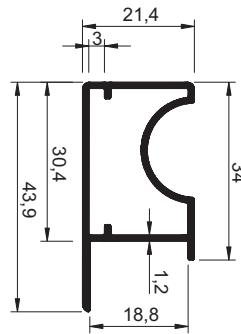

DES-1400

PUXADOR ENCAIXE - MDF 18mm

0,386 Kg/m

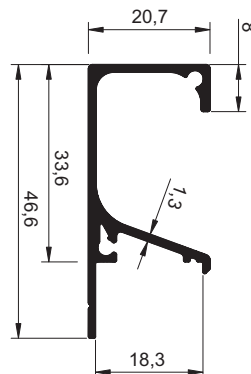

PONTEIRA COMPATÍVEL

PRETO | BRANCO | CROMO

BRONZE | FOSCO | INOX



A ALUMICONTE reserva-se o direito de fazer modificações em qualquer informação escrita neste catálogo sem aviso prévio. Os desenhos aqui contidos possuem medidas teóricas de massa e tolerâncias dimensionais de acordo com a ABNT NBR-8116, podendo haver variações dessas informações no produto final.

DES-197

PUXADOR ENCAIXE - MDF 18mm
0,387 Kg/m

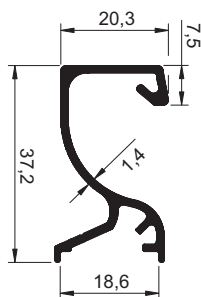

PONTEIRAS COMPATÍVEIS

BRANCO | BRONZE | CROMO
FOSCO | INOX | PRETO

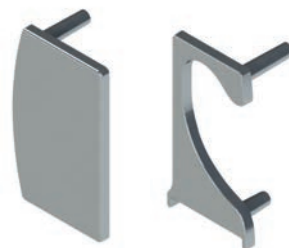

DES-201

PUXADOR ENCAIXE - MDF 18mm
0,456 Kg/m

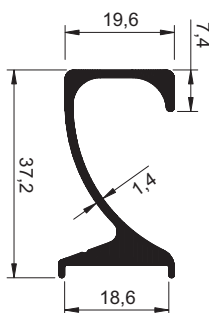

DES-931

PUXADOR ENCAIXE - MDF 18mm
0,581 Kg/m

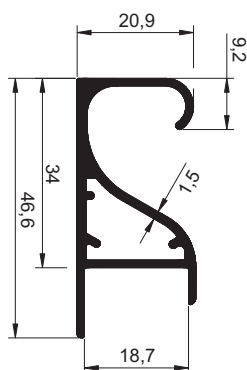

DES-949

PUXADOR ENCAIXE - MDF 18 mm
0,469 Kg/m

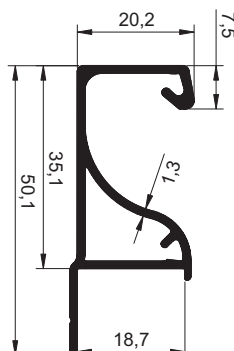

DES-999

PUXADOR ENCAIXE - MDF 18mm

0,433 Kg/m

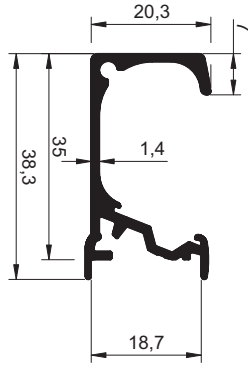

PONTEIRA COMPATÍVEL
BRANCO | BRONZE | CROMO
FOSCO | INOX | PRETO



DES-1063

PUXADOR ENCAIXE - MDF 18 mm

0,462 Kg/m

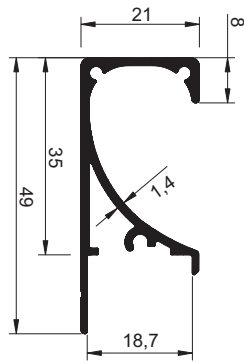

PONTEIRAS COMPATÍVEIS
BRANCO | BRONZE | CROMO
FOSCO | INOX | PRETO

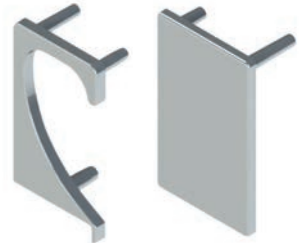

DES-1069

BASE CLICK PERFIL ENCAIXE DES-1068

0,121 Kg/m

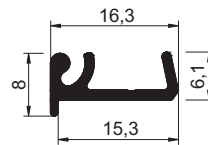

DES-1068

PUXADOR ENCAIXE - MDF 18mm

0,386 Kg/m

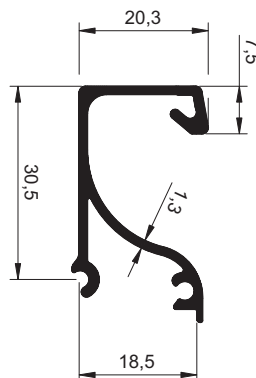

A ALUMICONTE reserva-se o direito de fazer modificações em qualquer informação escrita neste catálogo sem aviso prévio. Os desenhos aqui contidos possuem medidas teóricas de massa e tolerâncias dimensionais de acordo com a ABNT NBR-8116, podendo haver variações dessas informações no produto final.

DES-923

PUXADOR ENCAIXE

0,259 Kg/m

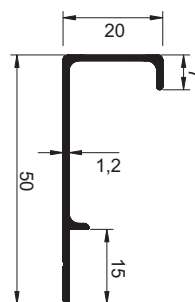

DES-173

PUXADOR ENCAIXE - MDF 18mm

0,437 Kg/m

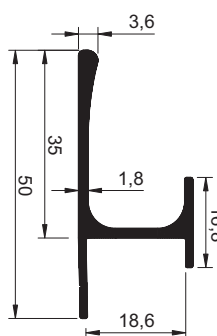

DES-404

PUXADOR ENCAIXE - MDF 18mm

0,327 Kg/m

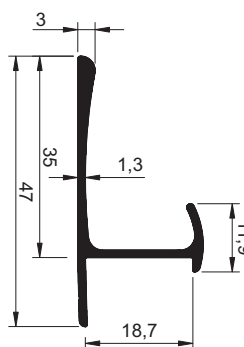

DES-224

PUXADOR ENCAIXE 45° - MDF 18mm

0,378 Kg/m

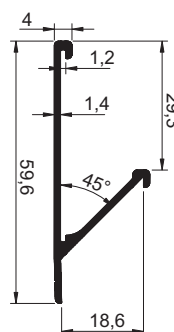

DES-1404

PUXADOR ENCAIXE 45° - MDF 18 mm
0,369 Kg/m

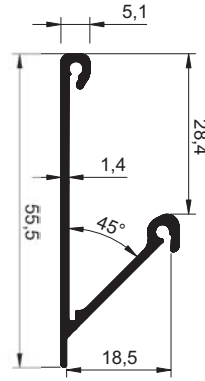

DES-1432

PUXADOR ENCAIXE 45° - MDF 18 mm
0,397 Kg/m

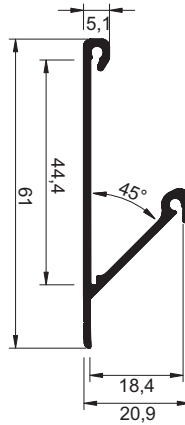

PONTEIRAS COMPATÍVEIS

BRANCO | BRONZE | CROMO
FOSCO | INOX | PRETO



DES-305

PUXADOR ENCAIXE - 30° - MDF 18mm
0,508 Kg/m

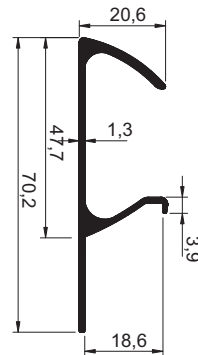

A ALUMICONTE reserva-se o direito de fazer modificações em qualquer informação escrita neste catálogo sem aviso prévio. Os desenhos aqui contidos possuem medidas teóricas de massa e tolerâncias dimensionais de acordo com a ABNT NBR-8116, podendo haver variações dessas informações no produto final.

DES-108

PUXADOR ENCAIXE - MDF 18mm C/ EPIGA
0,500 Kg/m

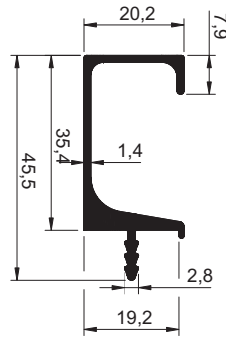

DES-132

PUXADOR ENCAIXE - MDF 18mm C/ EPIGA
0,439 Kg/m

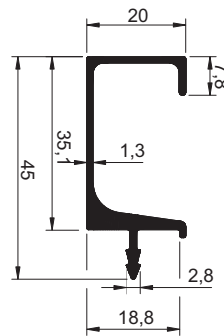

DES-142

PUXADOR ENCAIXE - MDF 18mm C/ EPIGA
0,441 Kg/m

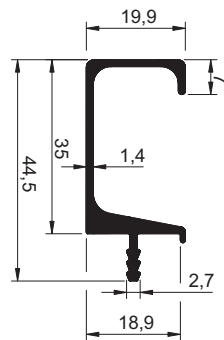

DES-314

PUXADOR ENCAIXE - MDF 18mm C/ EPIGA
0,457 Kg/m

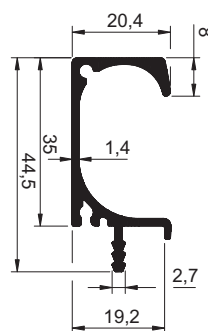

PONTEIRA COMPATÍVEL
BRANCO | BRONZE | CROMO
FOSCO | INOX | PRETO



DES-337

PUXADOR ENCAIXE - 18mm C/ ESPIGA
0,502 Kg/m

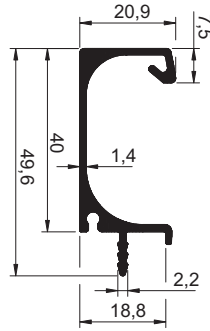

DES-611

PUXADOR ENCAIXE - MDF 18mm C/ ESPIGA
0,437 Kg/m

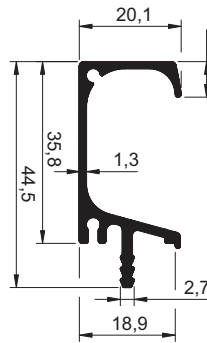

PONTEIRA COMPATÍVEL
BRANCO | BRONZE | CROMO
FOSCO | INOX | PRETO



DES-266

PUXADOR ENCAIXE - MDF 18 mm C/ ESPIGA
0,390 Kg/m

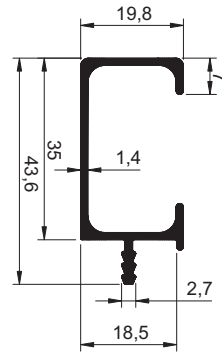

DES-022

PUXADOR ENCAIXE - MDF 18 mm C/ ESPIGA
0,438 Kg/m

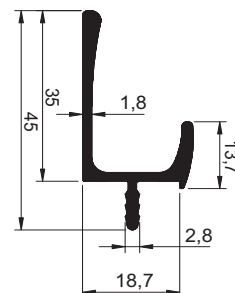

A ALUMICONTE reserva-se o direito de fazer modificações em qualquer informação escrita neste catálogo sem aviso prévio. Os desenhos aqui contidos possuem medidas teóricas de massa e tolerâncias dimensionais de acordo com a ABNT NBR-816, podendo haver variações dessas informações no produto final.

DES-192

PUXADOR ENCAIXE - 30° - MDF 18 mm C/ ESPIGA

0,403 Kg/m

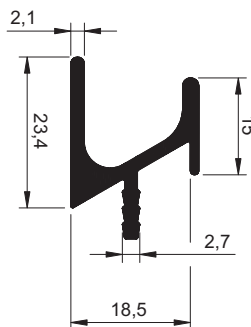

DES-094

PUXADOR ENCAIXE 30° - MDF 18mm C/ ESPIGA

0,392 Kg/m

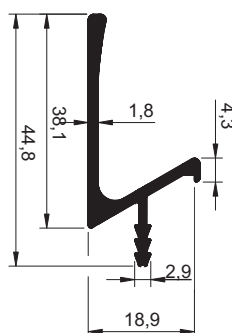

DES-1272

PUXADOR ENCAIXE - MDF 18mm C/ESPIGA

0,347 Kg/m

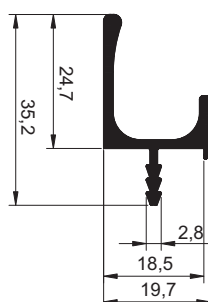

DES-622

PUXADOR ENCAIXE C/ ESPIGA

0,505 Kg/m

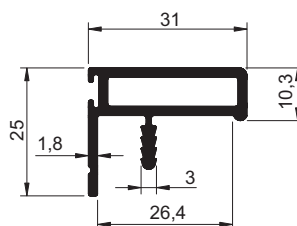

DES-623

PUXADOR ENCAIXE C/ ESPIGA
0,745 Kg/m

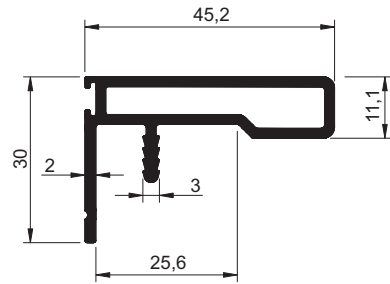
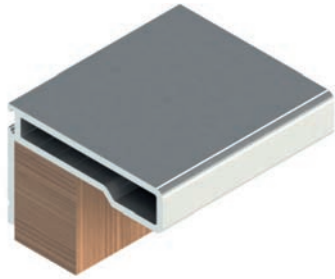

DES-1273

PUXADOR ENCAIXE MDF 18mm C/ ESPIGA
0,290 Kg/m

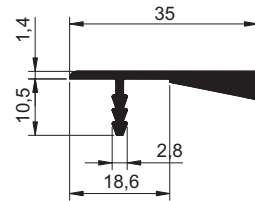
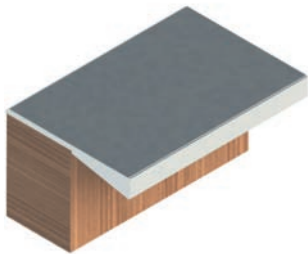

DES-1696

PERFIL PUXADOR C/ ESPIGA - MDF 18mm
0,268 Kg/m

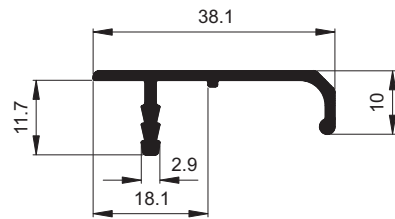
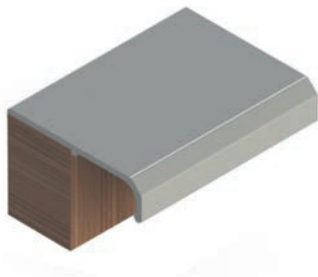

DES-1465

PUXADOR ENCAIXE ESPIGA DUPLA - MDF 18mm
0,406 Kg/m

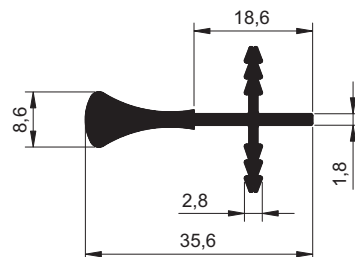

A ALUMICONTE reserva-se o direito de fazer modificações em qualquer informação escrita neste catálogo sem aviso prévio. Os desenhos aqui contidos possuem medidas teóricas de massa e tolerâncias dimensionais de acordo com a ABNT NBR-8116, podendo haver variações dessas informações no produto final.

DES-883

PUXADOR EMBUTIR C/ ESPIGA | 23mm
0,726 Kg/m

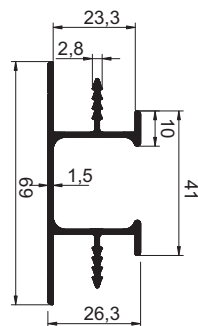

DES-2167

PERFIL PUXADOR C/ RELEVO
0,244 Kg/m

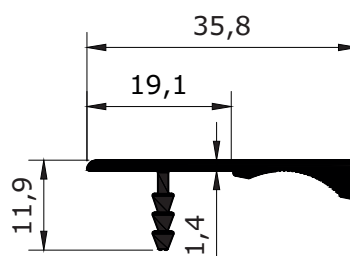
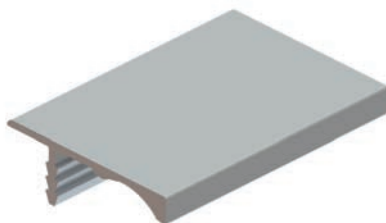



DES-213

PUXADOR ENCAIXE - MDF 15mm
0,392 Kg/m

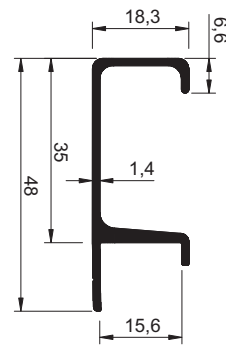

DES-270

PUXADOR ENCAIXE - MDF 15mm
0,315 Kg/m

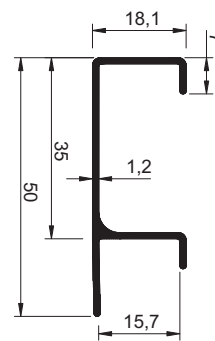

DES-339

PUXADOR ENCAIXE - MDF 15mm
0,284 Kg/m

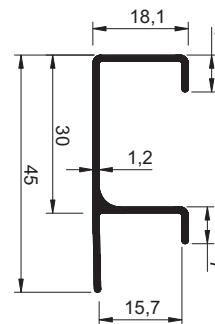

DES-214

PUXADOR ENCAIXE - MDF 15mm
0,498 Kg/m

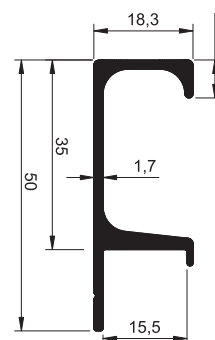

DES-284

PUXADOR ENCAIXE - MDF 15 mm

0,349 Kg/m

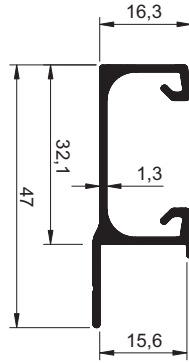

PONTEIRA COMPATÍVEL

BRANCO | BRONZE | CROMO
FOSCO | INOX | PRETO



DES-621

PUXADOR ENCAIXE - MDF 15mm

0,420 Kg/m

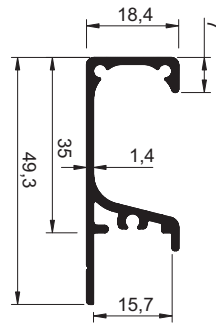

PONTEIRAS COMPATÍVEIS

BRANCO | BRONZE | CROMO
FOSCO | INOX | PRETO

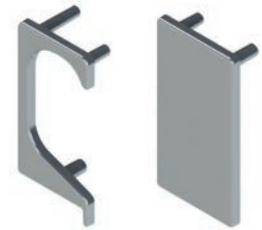

DES-970

PUXADOR ENCAIXE - MDF 15mm

0,353 Kg/m

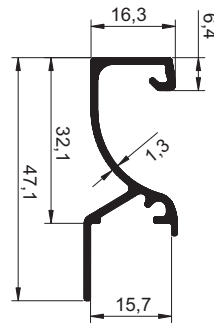

PONTEIRAS COMPATÍVEIS

BRANCO | BRONZE | CROMO
FOSCO | INOX | PRETO

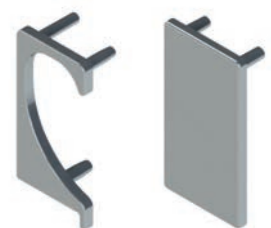

DES-1062

PUXADOR ENCAIXE - MDF 15mm

0,461 Kg/m

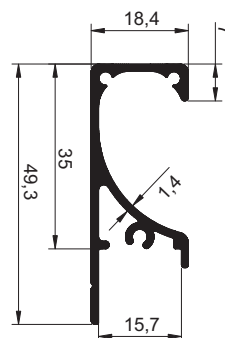

PONTEIRAS COMPATÍVEIS

BRANCO | BRONZE | CROMO
FOSCO | INOX | PRETO

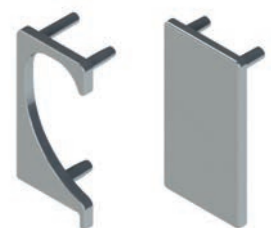

ALUMICONTE reserva-se o direito de fazer modificações em qualquer informação escrita neste catálogo sem aviso prévio. Os desenhos aqui contidos possuem medidas teóricas de massa e tolerâncias dimensionais de acordo com a ABNT NBR-816, podendo haver variações dessas informações no produto final.

DES-1077

PUXADOR ENCAIXE - 15 mm
0,324 Kg/m

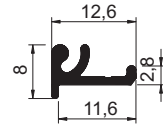
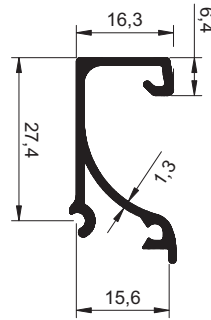

DES-1078

BASE CLICK PERFIL ENCAIXE
DES-1077
0,092 Kg/m



DES-1401

PUXADOR ENCAIXE - MDF 15mm
0,340 Kg/m

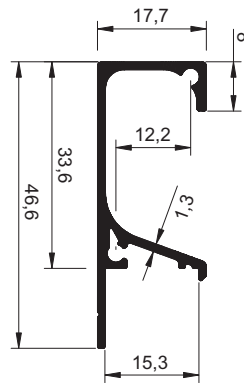

PONTEIRAS COMPATÍVEIS
BRANCO | BRONZE | CROMO
FOSCO | INOX | **PRETO**



DES-312

PUXADOR ENCAIXE - MDF 15mm
0,315 Kg/m

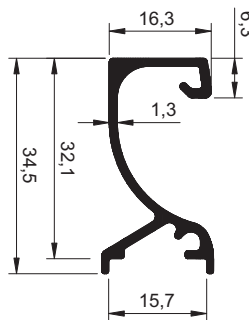

PONTEIRA COMPATÍVEL
BRANCO | BRONZE | CROMO
FOSCO | INOX | **PRETO**



DES-162

PUXADOR ENCAIXE - MDF 15mm
0,437 Kg/m

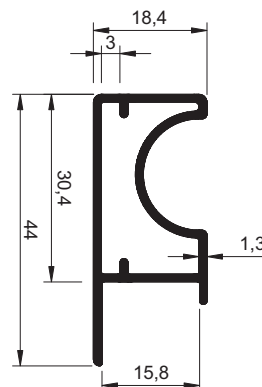

DES-194

PUXADOR ENCAIXE - MDF 15 mm

0,517 Kg/m

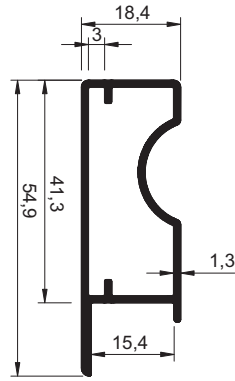

DES-222

PUXADOR ENCAIXE - MDF 15 mm

0,384 Kg/m

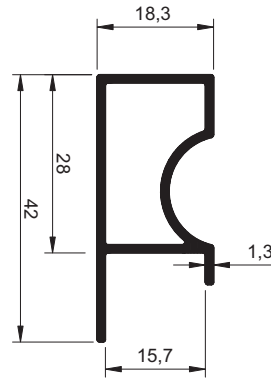
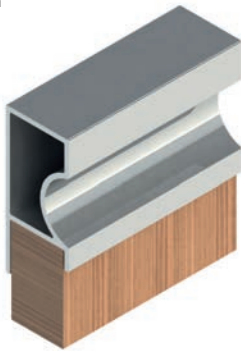

DES-234

PUXADOR ENCAIXE - MDF 15mm

0,265 Kg/m

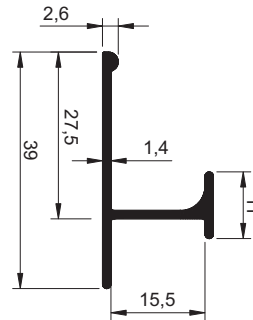

DES-1011

PUXADOR ENCAIXE - MDF 15mm

0,273 Kg/m

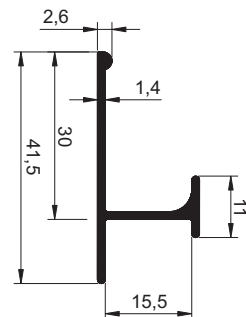

A ALUMICONTE reserva-se o direito de fazer modificações em qualquer informação escrita neste catálogo sem aviso prévio. Os desenhos aqui contidos possuem medidas teóricas de massa e tolerâncias dimensionais de acordo com a ABNT NBR-8116, podendo haver variações dessas informações no produto final.

DES-345

PUXADOR ENCAIXE - MDF 15mm

0,273 Kg/m

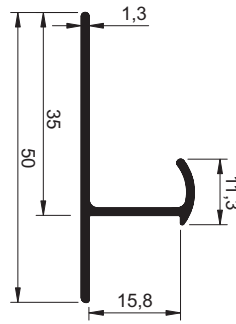

DES-238

PUXADOR ENCAIXE - MDF 15mm C/ ESPIGA

0,377 Kg/m

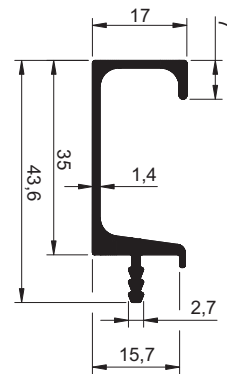

DES-265

PUXADOR ENCAIXE - MDF 15mm C/ ESPIGA

0,369 Kg/m

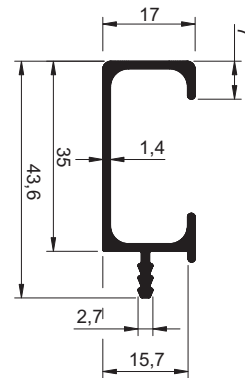

DES-1322

PUXADOR ENCAIXE - MDF 15mm C/ ESPIGA

0,412 Kg/m

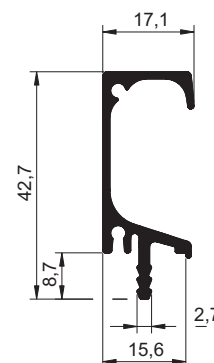

DES-221

PUXADOR ENCAIXE - MDF 15mm C/ ESPIGA

0,279 Kg/m

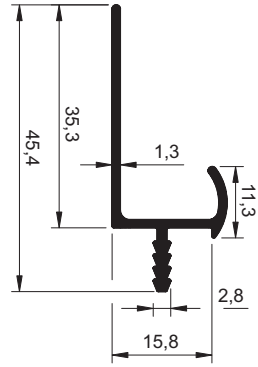

DES-933

PUXADOR ENCAIXE 45° - MDF 15 mm

0,342 Kg/m

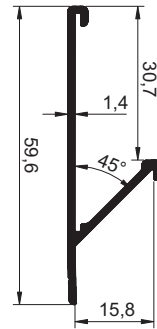

DES-1405

PUXADOR ENCAIXE 45° - MDF 15mm

0,363 Kg/m

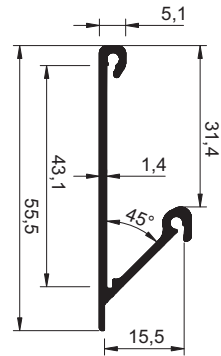

DES-1431

PUXADOR ENCAIXE 45° - MDF 15mm

0,383 Kg/m

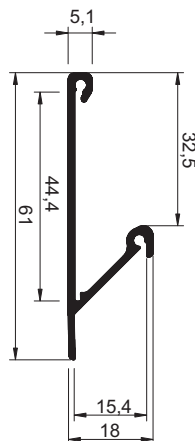

PONTEIRA COMPATÍVEL
BRANCO | BRONZE | CROMO
FOSCO | INOX | PRETO



A ALUMICONTE reserva-se o direito de fazer modificações em qualquer informação escrita neste catálogo sem aviso prévio. Os desenhos aqui contidos possuem medidas teóricas de massa e tolerâncias dimensionais de acordo com a ABNT NBR-816, podendo haver variações dessas informações no produto final.

DES-043

PUXADOR ENCAIXE - 23mm
0,304 Kg/m

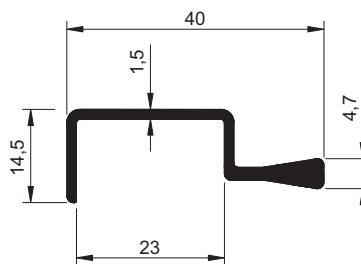

COMPATÍVEL · MONTAGEM

DES-233 **DES-1326**
DES-297 **DES-1466**
DES-832 **DES-1612**
DES-902

DES-239

PUXADOR ENCAIXE
0,283 Kg/m

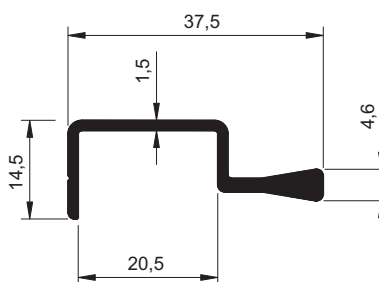
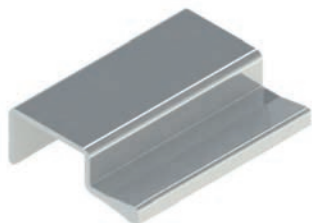

COMPATÍVEL · MONTAGEM

DES-007 **DES-721**
DES-008 **DES-875**
DES-014 **DES-1264**
DES-130
DES-198

DES-519

PUXADOR ENCAIXE - 18mm
0,282 Kg/m

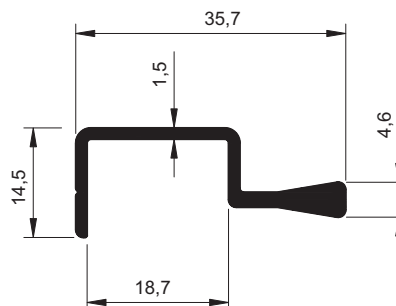

COMPATÍVEL · MONTAGEM

DES-084 **DES-1250**
DES-300 **DES-1443**
DES-1070

DES-1613

PUXADOR ENCAIXE - 23mm
0,356 Kg/m

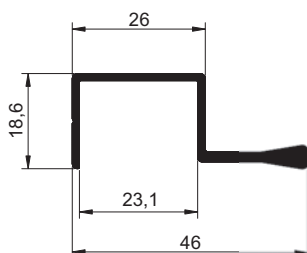
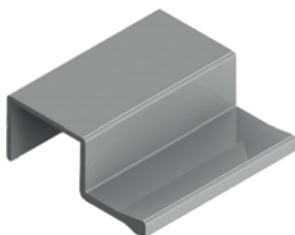

COMPATÍVEL · MONTAGEM
DES-002

DES-2185

PUXADOR QUADRO 20
0,277Kg/m

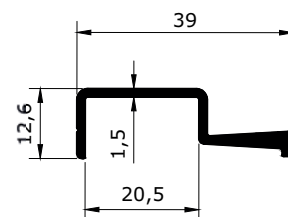
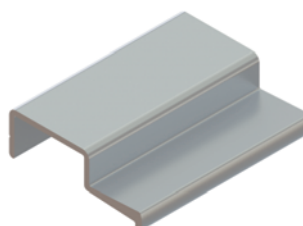

DES-1614

PUXADOR ENCAIXE - 18mm
0,345 Kg/m

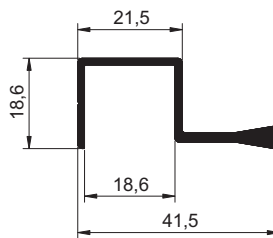

COMPATÍVEL • MONTAGEM
DES-300
DES-912

DES-1615

PUXADOR ENCAIXE - 15mm
0,346 Kg/m

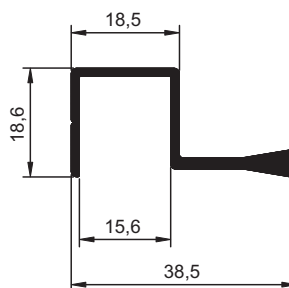

DES-1420

PUXADOR ENCAIXE
0,368 Kg/m

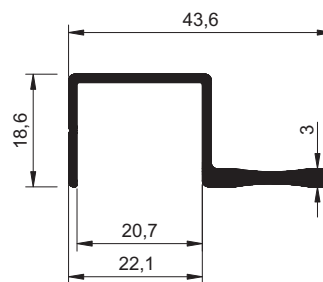

DES-1421

PUXADOR ENCAIXE
0,360 Kg/m

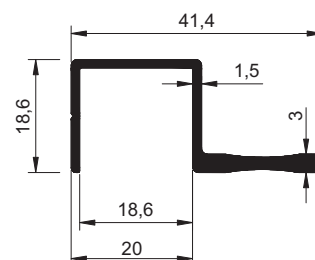
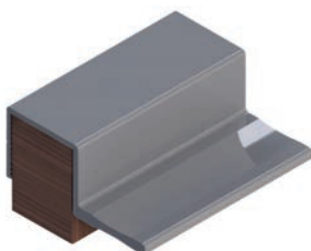

A ALUMICONTE reserva-se o direito de fazer modificações em qualquer informação escrita neste catálogo sem aviso prévio. Os desenhos aqui contidos possuem medidas teóricas de massa e tolerâncias dimensionais de acordo com a ABNT NBR-8116, podendo haver variações dessas informações no produto final.

DES-1251

PUXADOR ENCAIXE
0,266 Kg/m

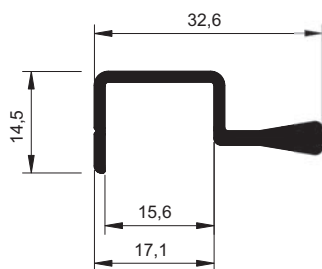

DES-2184

PUXADOR MDF 18
0,269 Kg/m

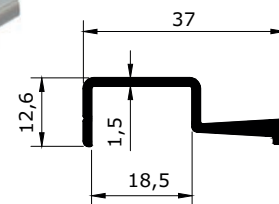
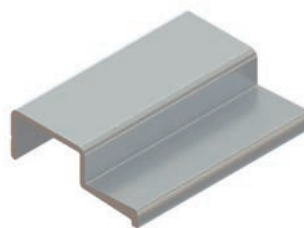

DES-1252

PUXADOR ENCAIXE
0,262 Kg/m

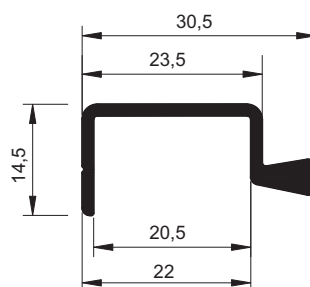
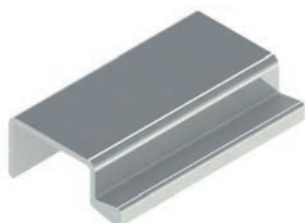

COMPATÍVEL · MONTAGEM

- ARM-062**
- ARM-198**
- DES-010**
- DES-014**
- DES-130**
- DES-198**

DES-1280

PUXADOR ENCAIXE
0,382 Kg/m

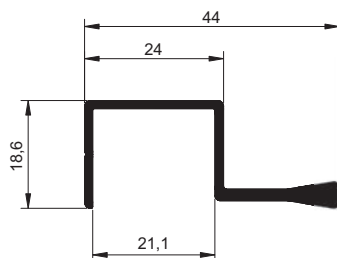

COMPATÍVEL · MONTAGEM
DES-010 | DES-130

DES-2193

PERFIL PUXADOR 25
0,409 Kg/m

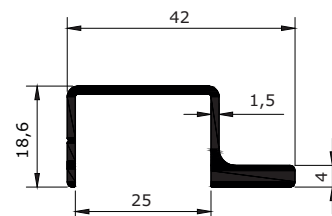
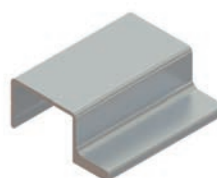

COMPATÍVEL · MONTAGEM
DES-1789
DES-2192

DES-112

PUXADOR ENCAIXE
0,316 Kg/m

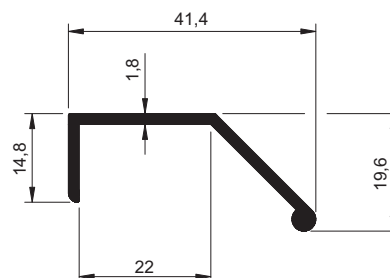
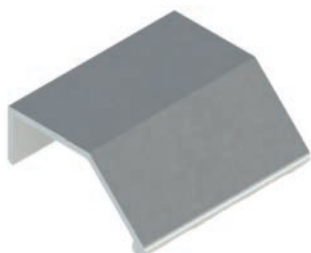

COMPATÍVEL · MONTAGEM

- DES-001** **DES-297**
- DES-002** **DES-902**
- DES-198** **DES-1612**
- DES-233**

DES-695

PUXADOR ENCAIXE - 18mm

0,311 Kg/m

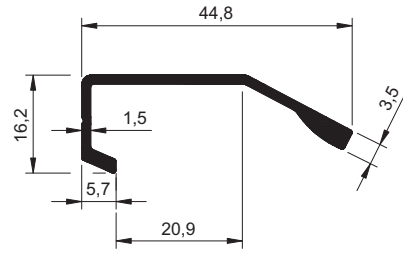

DES-833

PUXADOR ENCAIXE

0,320 Kg/m

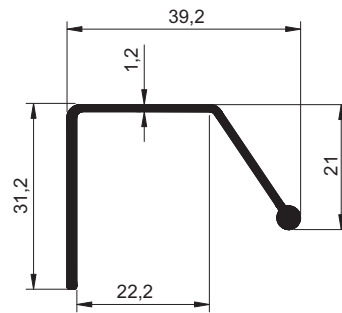

COMPATÍVEL · MONTAGEM

DES-002

DES-020

DES-902

DES-1612

DES-842

PUXADOR ENCAIXE

0,242 Kg/m

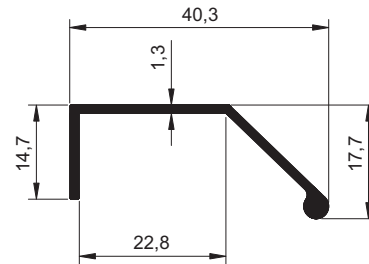
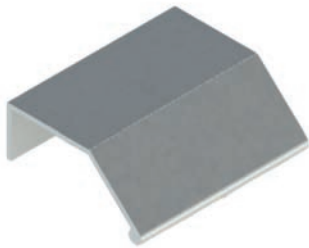

COMPATÍVEL · MONTAGEM

DES-001 DES-297

DES-002 DES-902

DES-020 DES-1612

DES-233

DES-144

PUXADOR ENCAIXE

0,260 Kg/m

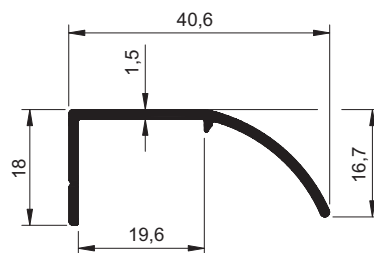
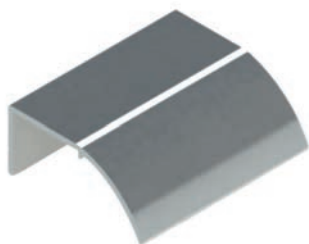

COMPATÍVEL · MONTAGEM

DES-073

DES-147

DES-145

PUXADOR ENCAIXE
0,267 Kg/m

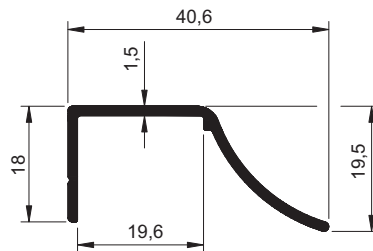
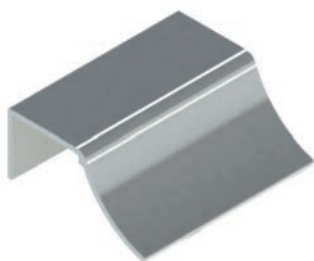

COMPATÍVEL · MONTAGEM

DES-073

DES-147

DES-951

DES-296

PUXADOR ENCAIXE
0,246 Kg/m

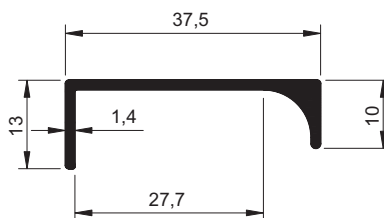
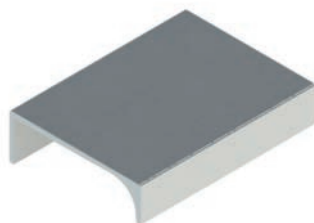

DES-395

PUXADOR ENCAIXE
0,293 Kg/m

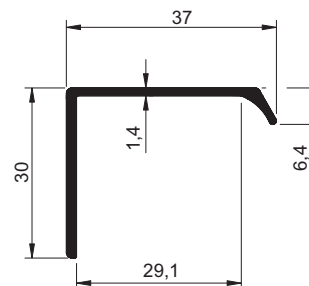
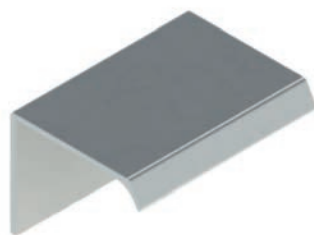

COMPATÍVEL · MONTAGEM

ARM-062

ARM-198

DES-908

PUXADOR ENCAIXE
0,434 Kg/m

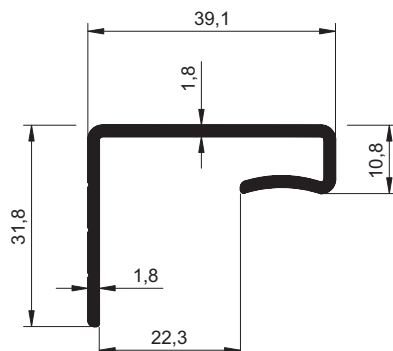
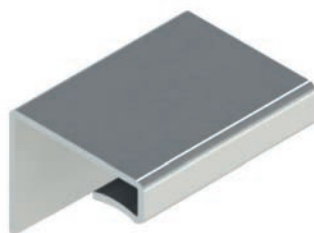

COMPATÍVEL · MONTAGEM

DES-297

DES-832

DES-902

DES-1326

DES-1319

PUXADOR ENCAIXE
0,372 Kg/m

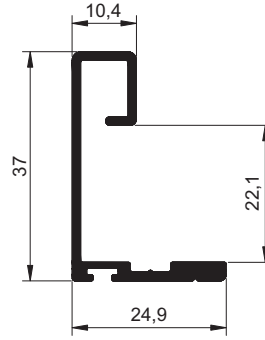

DES-1329

PUXADOR ENCAIXE
0,364 Kg/m

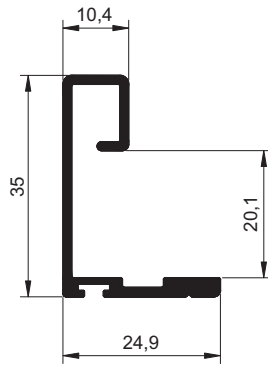

DES-1332

PUXADOR ENCAIXE
0,383 Kg/m

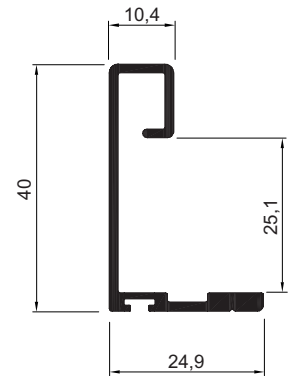

DES-203

PUXADOR ENCAIXE - 15mm
0,259 Kg/m

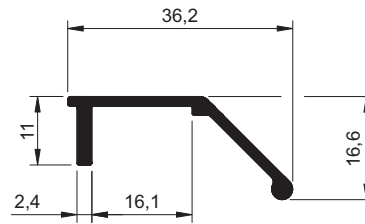

COMPATÍVEL · MONTAGEM

- DES-010
- DES-130
- DES-198
- DES-311
- DES-691

DES-909

PUXADOR ENCAIXE
0,279 Kg/m

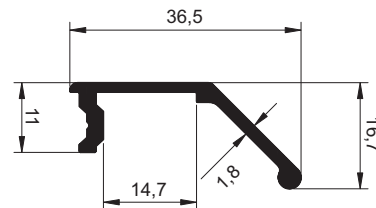
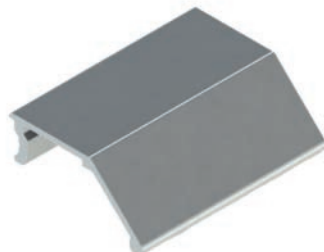

COMPATÍVEL · MONTAGEM

- DES-073

A ALUMICONTE reserva-se o direito de fazer modificações em qualquer informação escrita neste catálogo sem aviso prévio. Os desenhos aqui contidos possuem medidas teóricas de massa e tolerâncias dimensionais de acordo com a ABNT NBR-816, podendo haver variações dessas informações no produto final.

DES-993

PUXADOR ENCAIXE

0,214 Kg/m

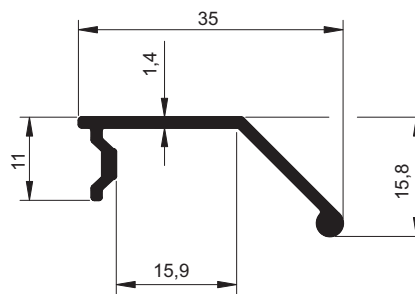
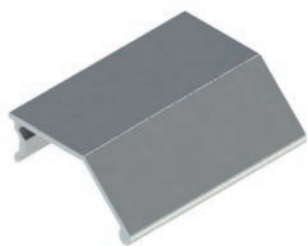

DES-1278

PUXADOR ENCAIXE

0,268 Kg/m

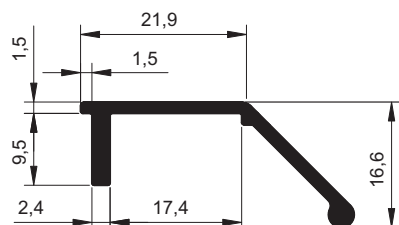
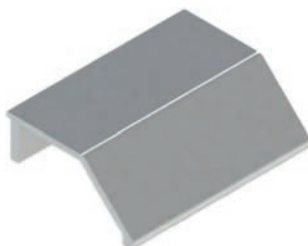

COMPATÍVEL · MONTAGEM

DES-233

DES-297

DES-148

PUXADOR ENCAIXE INTERNO

0,245 Kg/m

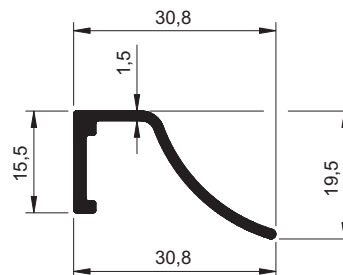

DES-149

PUXADOR ENCAIXE INTERNO

0,238 Kg/m

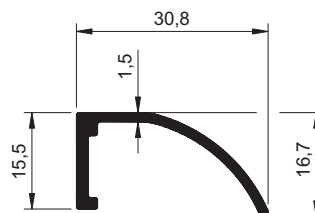

DES-1013

PUXADOR ENCAIXE
0,308 Kg/m

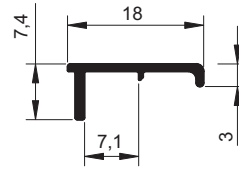

DES-901

PUXADOR ENCAIXE
0,230 Kg/m

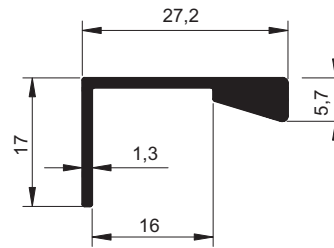
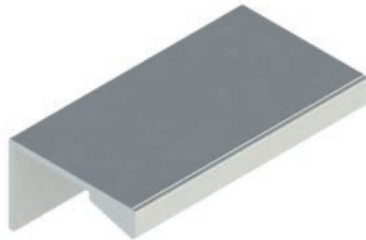

DES-1299

PUXADOR ENCAIXE
0,261 Kg/m

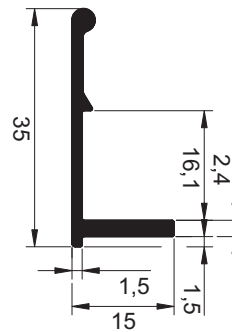

COMPATÍVEL · MONTAGEM

- DES-010 DES-311
- DES-062 DES-691
- DES-130 DES-875
- DES-198

DES-1324

PUXADOR ENCAIXE
0,218 Kg/m

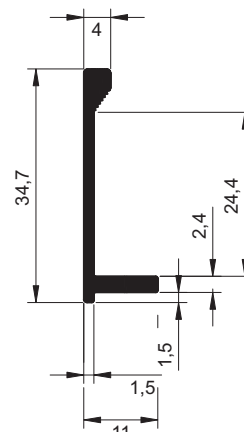

COMPATÍVEL · MONTAGEM

- DES-010 DES-311
- DES-062 DES-691
- DES-130 DES-875
- DES-198
- DES-233

A ALUMICONTE reserva-se o direito de fazer modificações em qualquer informação escrita neste catálogo sem aviso prévio. Os desenhos aqui contidos possuem medidas teóricas de massa e tolerâncias dimensionais de acordo com a ABNT NBR-8116, podendo haver variações dessas informações no produto final.

DES-063

PUXADOR DE EMBUTIR
0,440 Kg/m

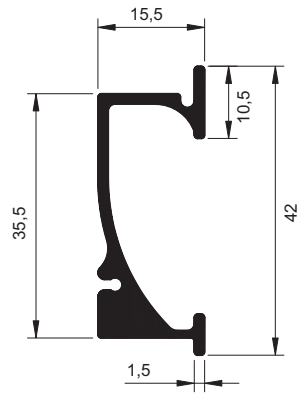
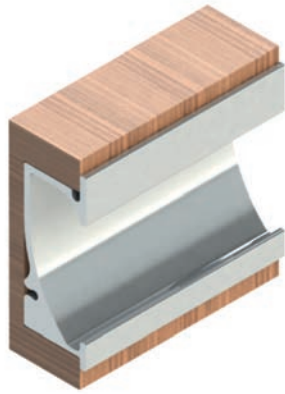

DES-064

PUXADOR EMBUTIR
0,366Kg/m

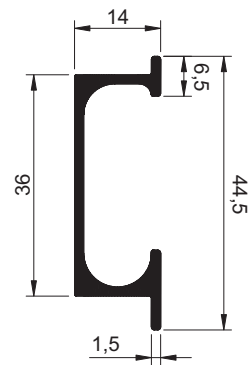
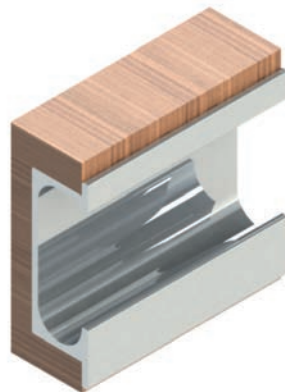

DES-046

PUXADOR EMBUTIR
0,112 Kg/m

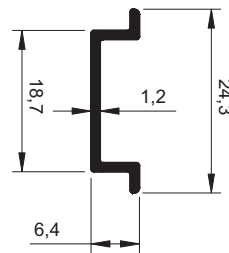

DES-347

PUXADOR EMBUTIR
0,354 Kg/m

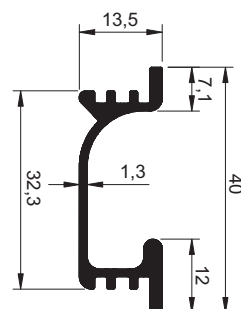

DES-881

PUXADOR EMBUTIR

0,383 Kg/m

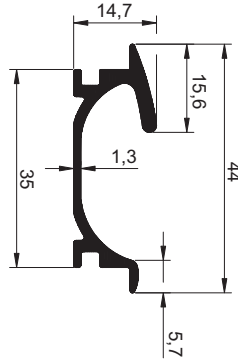

PONTEIRA COMPATÍVEL

CROMO | FOSCO | INOX



DES-1423

PUXADOR EMBUTIR

0,275 Kg/m

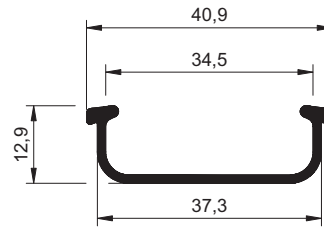

DES-090

PUXADOR FRONTAL

0,312 Kg/m

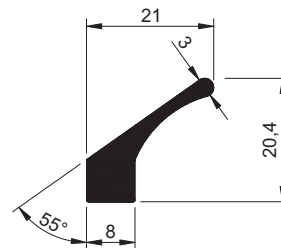

A ALUMICONTE reserva-se o direito de fazer modificações em qualquer informação escrita neste catálogo sem aviso prévio. Os desenhos aqui contidos possuem medidas teóricas de massa e tolerâncias dimensionais de acordo com a ABNT NBR-816, podendo haver variações dessas informações no produto final.

DES-175

PUXADOR **FRONTAL**

0,556 Kg/m

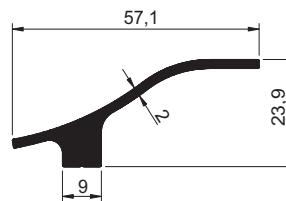
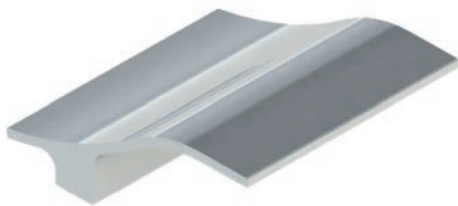

DES-680

PUXADOR **FRONTAL**

0,327 Kg/m

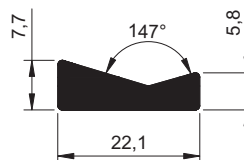
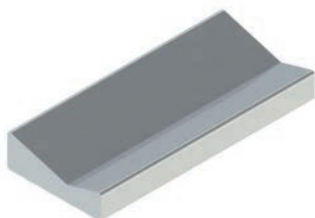

DES-826

PUXADOR **FRONTAL**

0,244 Kg/m

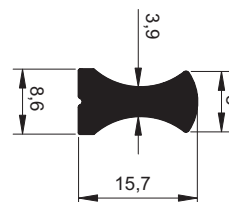

DES-872

PUXADOR **FRONTAL**

4,708 Kg/m

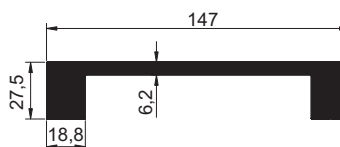
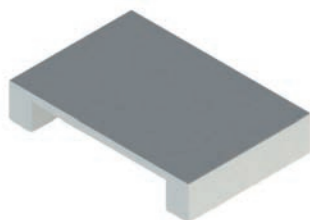

DES-879

PUXADOR **FRONTAL**
0,495 Kg/m

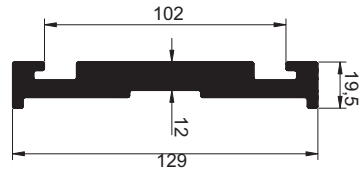
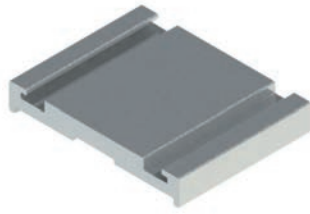

DES-976

PUXADOR **FRONTAL T**
0,458 Kg/m

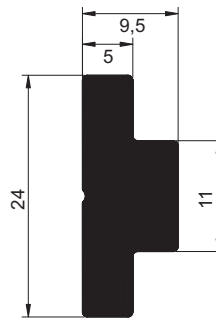

DES-232

PUXADOR ENCAIXE INTERNO 11mm
0,151 Kg/m

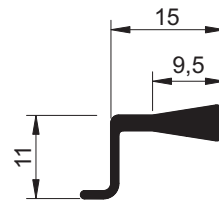

COMPATÍVEL · MONTAGEM
DES-233

DES-353

PUXADOR ENCAIXE INTERNO 11mm
0,209 Kg/m

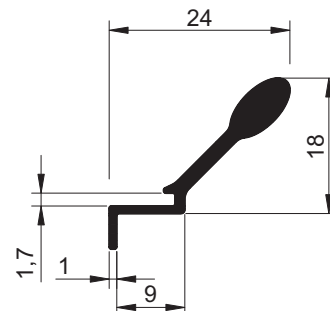

COMPATÍVEL · MONTAGEM
DES-233

PERFIL PARA QUADRO DE VIDRO

Com função de estruturar o quadro e receber a folha de vidro, esses perfis podem ser aplicados em diversas posições, de acordo com cada projeto.

DES-001

QUADRO VIDRO
0,466 Kg/m
22,3 x 45 x 5,2 mm



COMPATÍVEL · MONTAGEM
DES-158

COMPATÍVEL · PUXADOR
DES-112
DES-842

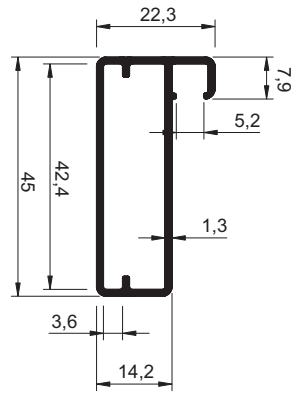

ESQUADRETA
ESQ-001



BAGUETE
BAG-009

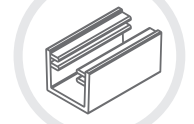

Vidro 4mm

DES-002

QUADRO VIDRO - 6,2mm
0,798 Kg/m
23 x 70 x 6,2 mm

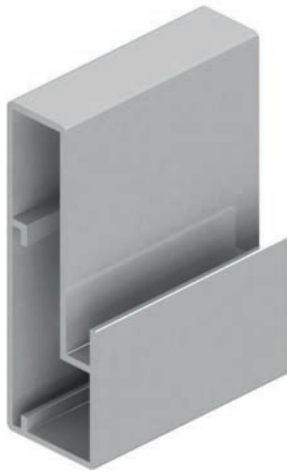

COMPATÍVEL · PUXADOR
DES-112
DES-833
DES-842
DES-1613

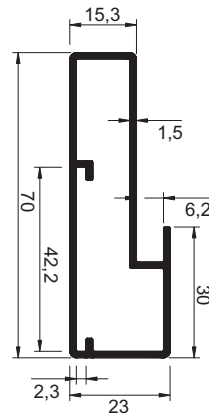

ESQUADRETA
ESQ-001



BAGUETE
BAG-009



Vidro 4mm

DES-007

QUADRO VIDRO - 5,0mm
0,508 Kg/m
20,4 x 48,2 x 5 mm



COMPATÍVEL · PUXADOR
DES-239

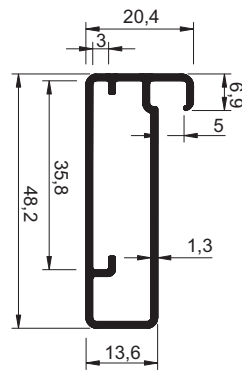

BAGUETE
BAG-013



Vidro 4mm

DES-008

QUADRO VIDRO - 4,9mm
0,576 Kg/m
20,4 x 48,2 x 4,9 mm



COMPATÍVEL · PUXADOR
DES-239

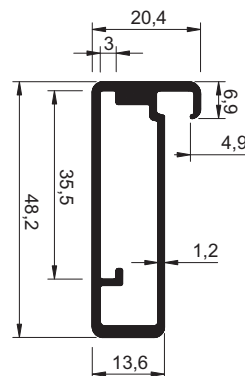

BAGUETE
BAG-013



Vidro 4mm

A ALUMICONTE reserva-se o direito de fazer modificações em qualquer informação escrita neste catálogo sem aviso prévio. Os desenhos aqui contidos possuem medidas teóricas de massa e tolerâncias dimensionais de acordo com a ABNT NBR-8116, podendo haver variações dessas informações no produto final.

DES-010

QUADRO VIDRO - 5,2mm
 0,451 Kg/m
 20,1 x 45 x 5,2 mm



COMPATÍVEL · PUXADOR
DES-203
DES-1252
DES-1280
DES-1299
DES-1324

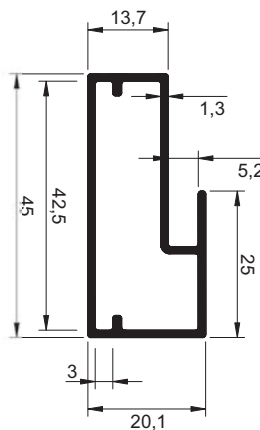

ESQUADRETA
ESQ-001

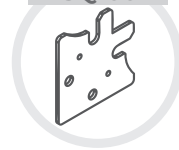

BAGUETE
BAG-007



DES-014

QUADRO VIDRO - 4,5mm
 0,459 Kg/m
 19,8 x 42 x 4,5 mm



COMPATÍVEL · PUXADOR
DES-239
DES-1252

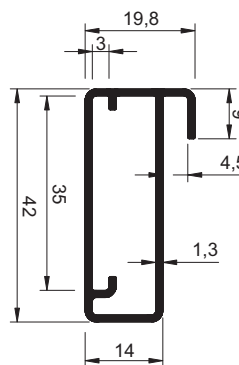

DES-832

QUADRO VIDRO
 0,688 Kg/m
 69 x 22 x 6,2 mm

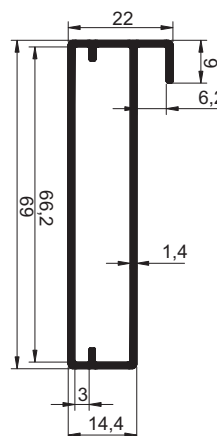

BAGUETE
BAG-009



DES-062

QUADRO VIDRO
 0,455 Kg/m
 20 x 45 x 6,7 mm

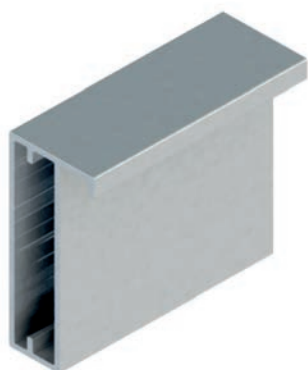

COMPATÍVEL · PUXADOR
DES-1299
DES-1324

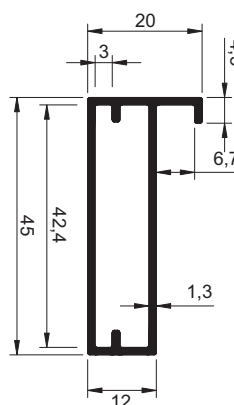

ESQUADRETA
ESQ-001



DES-084

QUADRO VIDRO
0,407 Kg/m
18 x 44,2 x 4,6 mm

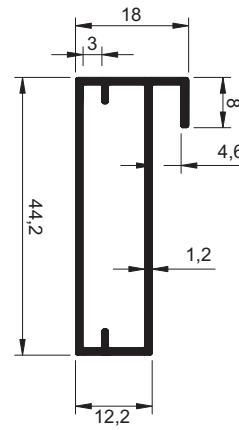

ESQUADRETA
ESQ-001



COMPATÍVEL · PUXADOR
DES-519

DES-133

QUADRO VIDRO
0,508 Kg/m
18,1 x 47 x 3,6 mm

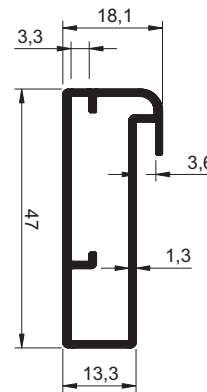

ESQUADRETA
ESQ-001



BAGUETE
BAG-008



Vidro 4mm

COMPATÍVEL · MONTAGEM
DES-877 DES-204
DES-950 DES-897
DES-282

COMPATÍVEL · PUXADOR
DES-112 DES-1252
DES-203 DES-1299
DES-239 DES-1324

DES-233

QUADRO VIDRO
0,479 Kg/m
22 x 45 x 6 mm

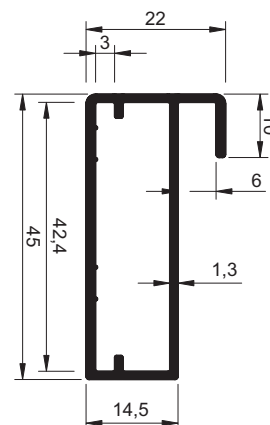

ESQUADRETA
ESQ-001



BAGUETE
BAG-009

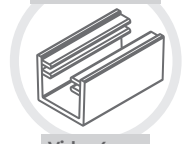

Vidro 4mm

COMPATÍVEL · PUXADOR
DES-043 DES-1278
DES-112 DES-1324
DES-842 DES-232

A ALUMICONTE reserva-se o direito de fazer modificações em qualquer informação escrita neste catálogo sem aviso prévio. Os desenhos aqui contidos possuem medidas teóricas de massa e tolerâncias dimensionais de acordo com a ABNT NBR-8116, podendo haver variações dessas informações no produto final.

DES-297

QUADRO VIDRO
0,671 Kg/m
22 x 65 x 6,2 mm

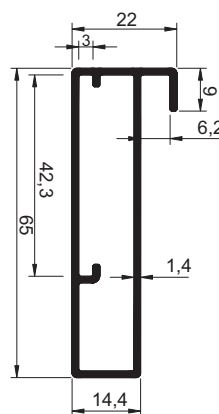

ESQUADRETA
ESQ-001



BAGUETE
BAG-009



Vidro 4mm

COMPATÍVEL · PUXADOR
DES-043 **DES-908**
DES-112 **DES-1278**
DES-842

DES-311

QUADRO VIDRO
0,454 Kg/m
20 x 45 x 4,8 mm

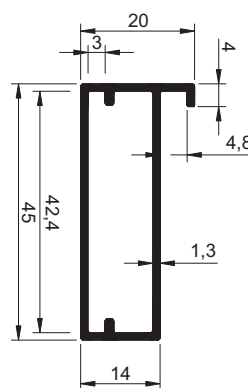

ESQUADRETA
ESQ-001



COMPATÍVEL · MONTAGEM
DES-370

COMPATÍVEL · PUXADOR
DES-203
DES-1299
DES-1324

DES-318

QUADRO VIDRO
0,427 Kg/m
18 x 45 x 5 mm

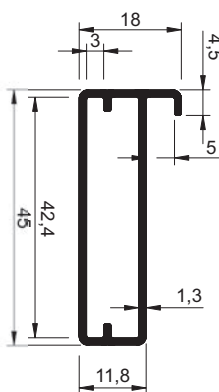

ESQUADRETA
ESQ-001



DES-523

QUADRO VIDRO
0,467 Kg/m
20,3 x 45 x 4,5 mm

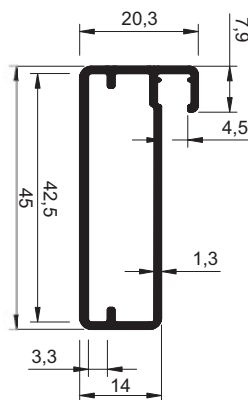

ESQUADRETA
ESQ-001



BAGUETE
BAG-008



Vidro 4mm

DES-530

QUADRO VIDRO
0,433 Kg/m
18 x 45 x 4,6 mm

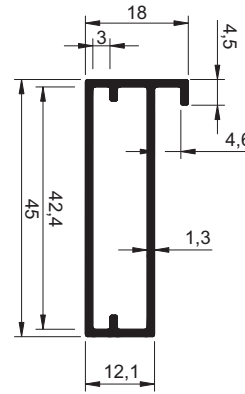

ESQUADRETA
ESQ-001



DES-550

QUADRO VIDRO
0,438 Kg/m
18 x 45 x 4,5 mm

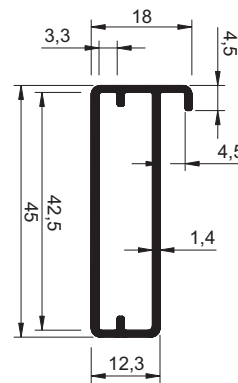

ESQUADRETA
ESQ-001



COMPATÍVEL · MONTAGEM
DES-551

DES-691

QUADRO VIDRO
0,502 Kg/m
20,2 x 45 x 4,3mm

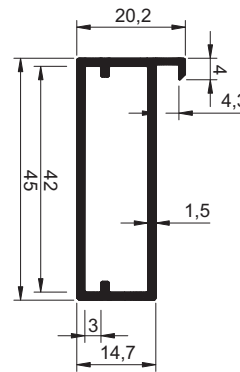

ESQUADRETA
ESQ-001



COMPATÍVEL · MONTAGEM
DES-690

COMPATÍVEL · PUXADOR
DES-203
DES-1299
DES-1324

DES-875

QUADRO VIDRO
0,443 Kg/m
20,3 x 45 x 5 mm

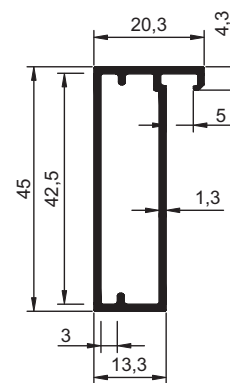

ESQUADRETA
ESQ-001



BAGUETE
BAG-011

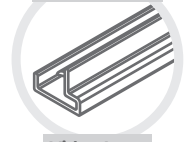

Vidro 4mm

A ALUMICONTE reserva-se o direito de fazer modificações em qualquer informação escrita neste catálogo sem aviso prévio. Os desenhos aqui contidos possuem medidas teóricas de massa e tolerâncias dimensionais de acordo com a ABNT NBR-8116, podendo haver variações dessas informações no produto final.

DES-902

QUADRO VIDRO
0,792 Kg/m
22 x 70 x 6,2mm

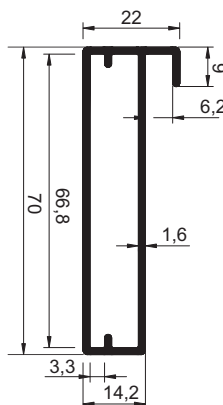

COMPATÍVEL · PUXADOR

DES-239

DES-1299

DES-1324

BAGUETE
BAG-009



Vidro 4mm

DES-929

QUADRO VIDRO
0,488 Kg/m
20,9 x 45 x 6,7 mm

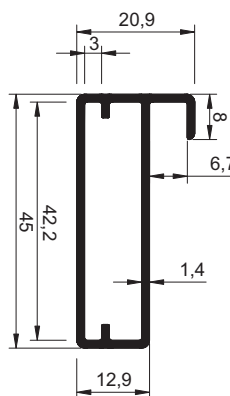

COMPATÍVEL · MONTAGEM

DES-930

ESQUADRETA
ESQ-001



BAGUETE
BAG-010



Vidro 4mm

DES-1060

QUADRO VIDRO
0,477 Kg/m
20,8 x 45,3 x 5,5 mm

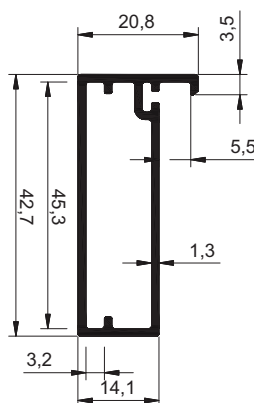

COMPATÍVEL · MONTAGEM

DES-1061

ESQUADRETA
ESQ-001



BAGUETE
BAG-012



Vidro 4mm

DES-1250

QUADRO VIDRO
0,443 Kg/m
18,6 x 45 x 4,5 mm

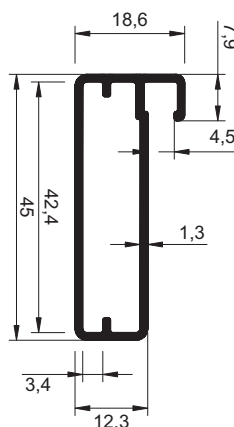

COMPATÍVEL · PUXADOR

DES-519

ESQUADRETA
ESQ-001



BAGUETE
BAG-008



Vidro 4mm

DES-1402

QUADRO VIDRO
0,497 Kg/m
20,3 x 45,2 x 5,5 mm

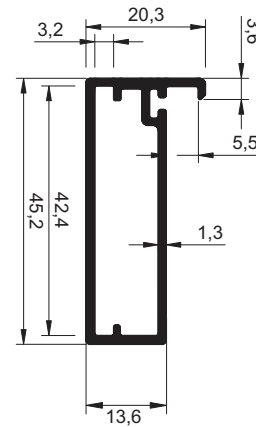

ESQUADRETA
ESQ-001



BAGUETE
BAG-014



Vidro 4mm

COMPATÍVEL · MONTAGEM
DES-1403

DES-1264

QUADRO VIDRO 45 x 20 mm
0,440 Kg/m
20 x 44,8 x 4,5 mm

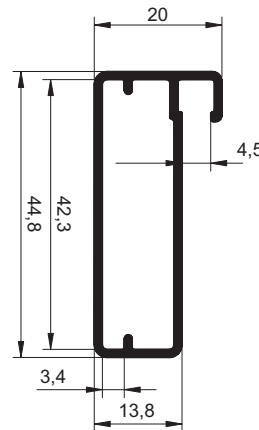

ESQUADRETA
ESQ-001



BAGUETE
BAG-008



Vidro 4mm

COMPATÍVEL · MONTAGEM
DES-1268

COMPATÍVEL · PUXADOR
DES-239

DES-1326

QUADRO VIDRO
0,658 Kg/m
21,9 x 70 x 5,6mm

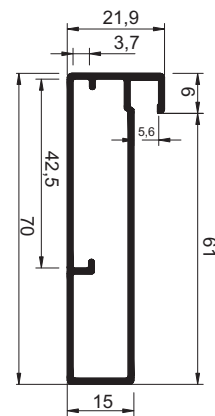

ESQUADRETA
ESQ-001



BAGUETE
BAG-008



Vidro 4mm

COMPATÍVEL · PUXADOR
DES-043
DES-908

DES-1452

QUADRO VIDRO
1,042 Kg/m
22,3 x 70,8 x 6mm

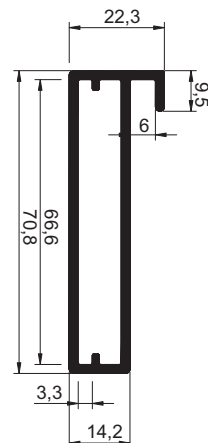

PRODUTO REFORÇADO

IDEAL PARA
PORTA DESLIZANTE

BAGUETE
BAG-009

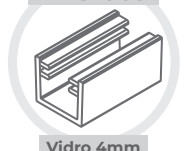

Vidro 4mm

COMPATÍVEL · MONTAGEM
DES-1451
DES-1453

A ALUMICONTE reserva-se o direito de fazer modificações em qualquer informação escrita neste catálogo sem aviso prévio. Os desenhos aqui contidos possuem medidas teóricas de massa e tolerâncias dimensionais de acordo com a ABNT NBR-8116, podendo haver variações dessas informações no produto final.

DES-1490

QUADRO VIDRO

0,546 Kg/m

25,4 x 26 x 4,8mm

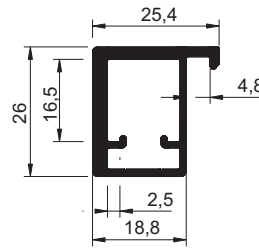

COMPATÍVEL · MONTAGEM
DES-1489

DES-1328

QUADRO VIDRO

0,863 Kg/m

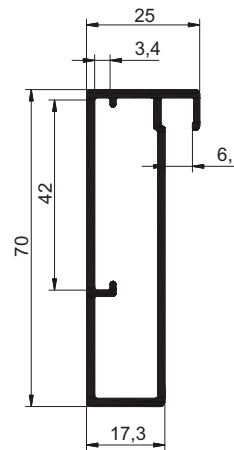

ESQUADRETA
ESQ-001



BAGUETE
BAG-009

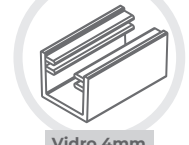

DES-1609

QUADRO VIDRO

0,458 Kg/m

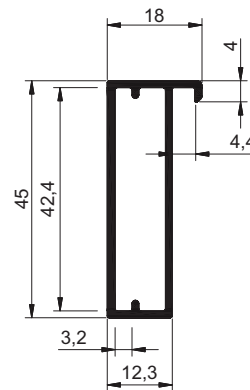

ESQUADRETA
ESQ-001



DES-1612

QUADRO VIDRO

0,819 Kg/m

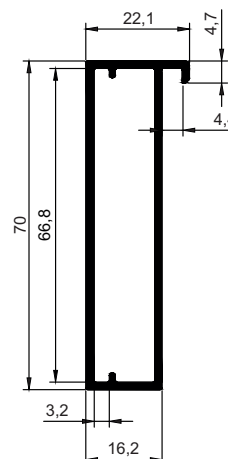

COMPATÍVEL · PUXADOR

DES-043

DES-112

DES-833

DES-842

DES-060

QUADRO VIDRO
0,422 Kg/m
17 x 45 x 5,2 mm

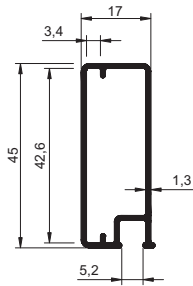

DES-1934

PERFIL FOLHA ENCAIXILHADA
0,301 Kg/m
23 x 19,5 x 4,8 mm

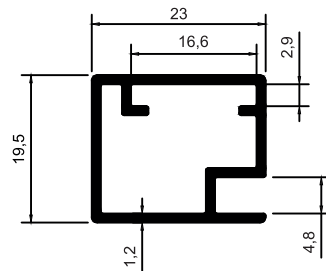
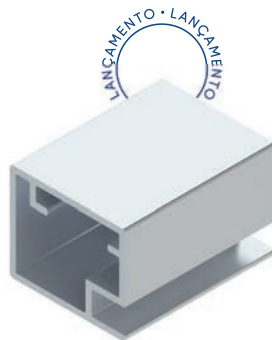

DES-129

QUADRO VIDRO
0,616 Kg/m
16,5 x 49 x 5 mm

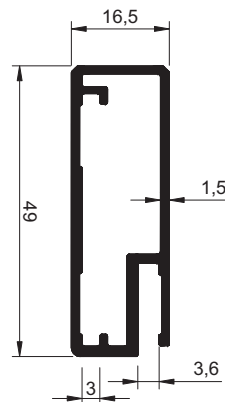

COMPATÍVEL · MONTAGEM
DES-130

DES-130

QUADRO VIDRO
0,945 Kg/m
20 x 75 x 3,6 mm

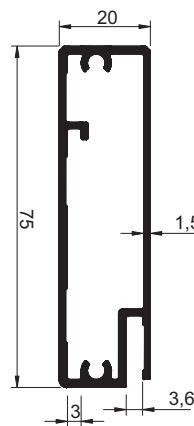

COMPATÍVEL · MONTAGEM
DES-129

COMPATÍVEL · PUXADOR

- DES-203** **DES-1299**
- DES-239** **DES-1324**
- DES-1252** **DES-1329**
- DES-1280**

DES-016

QUADRO VIDRO - 5,1mm
0,483 Kg/m
20 x 45,1 x 5,1 mm

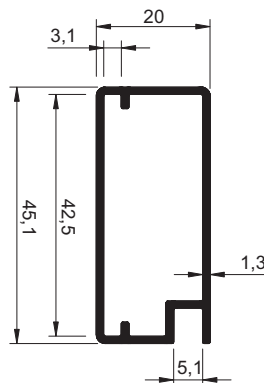

A ALUMICONTE reserva-se o direito de fazer modificações em qualquer informação escrita neste catálogo sem aviso prévio. Os desenhos aqui contidos possuem medidas teóricas de massa e tolerâncias dimensionais de acordo com a ABNT NBR-816, podendo haver variações dessas informações no produto final.

DES-300

QUADRO VIDRO
0,437 Kg/m
18 x 42 x 6 mm

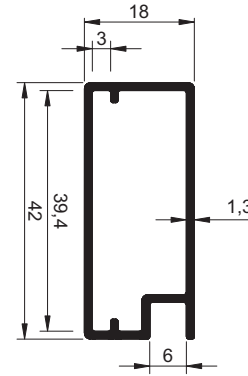

BAGUETE
BAG-009



Vidro 4mm

COMPATÍVEL · PUXADOR
DES-519
DES-1614

DES-1291

QUADRO VIDRO
0,576 Kg/m
44,9 x 18 x 6mm

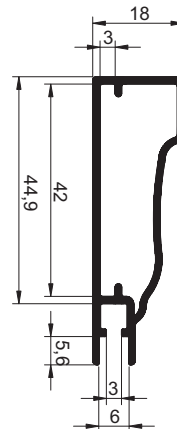

ESQUADRETA
ESQ-001



BAGUETE
BAG-009

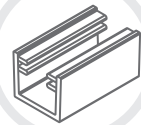

Vidro 4mm

DES-178

QUADRO VIDRO
0,376 Kg/m
15 x 35 x 5,2 mm

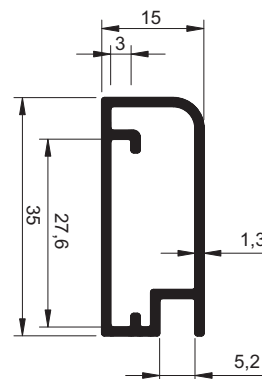

BAGUETE
BAG-008

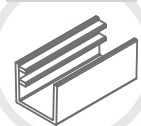

Vidro 4mm

DES-019

QUADRO VIDRO - 5,2mm
0,421 Kg/m
19,1 x 45 x 5,2 mm

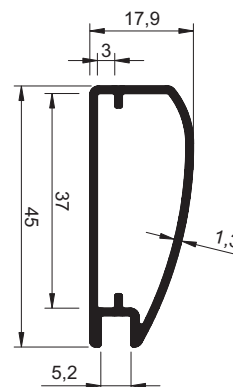

BAGUETE
BAG-008



Vidro 4mm

DES-015

QUADRO VIDRO - 5,2mm
0,372 Kg/m
18,3 x 39 x 5,2 mm

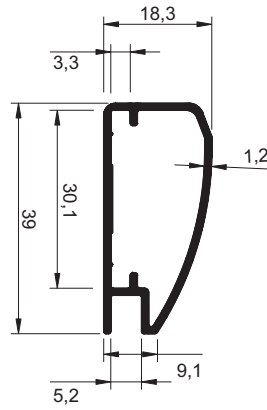

DES-017

QUADRO VIDRO
0,495 Kg/m
20,4 x 50 x 5,1 mm

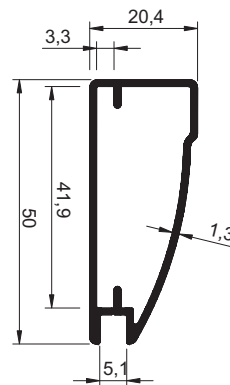

DES-018

QUADRO VIDRO
0,475 Kg/m
20,5 x 45 x 5 mm

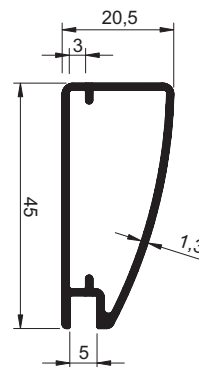

DES-073

QUADRO PELE VIDRO
0,473 Kg/m
19 x 45 x 5 mm

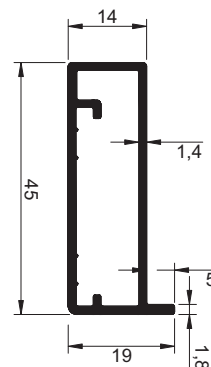

COMPATÍVEL • MONTAGEM
DES-816

COMPATÍVEL • PUXADOR
DES-144
DES-145
DES-909

A ALUMICONTE reserva-se o direito de fazer modificações em qualquer informação escrita neste catálogo sem aviso prévio. Os desenhos aqui contidos possuem medidas teóricas de massa e tolerâncias dimensionais de acordo com a ABNT NBR-816, podendo haver variações dessas informações no produto final.

DES-128

QUADRO PELE VIDRO
0,938 Kg/m
25 x 75 x 5 mm

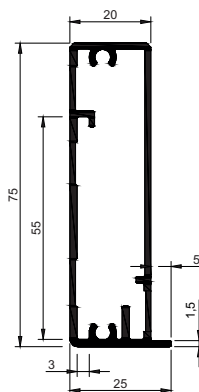

DES-147

QUADRO PELE VIDRO
0,382 Kg/m
18,8 x 45 x 4,8 mm

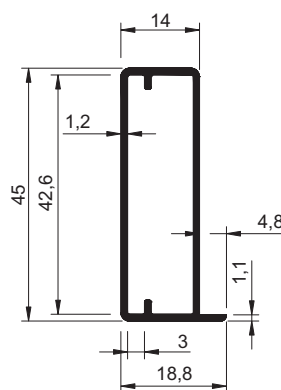

ESQUADRETA
ESQ-001



DES-226

QUADRO PELE VIDRO
0,591 Kg/m
22,5 x 53 x 5 mm

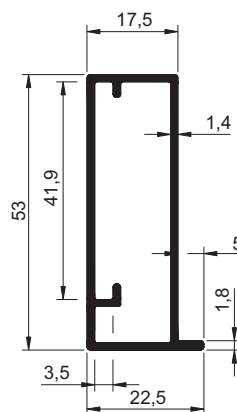

ESQUADRETA
ESQ-001



COMPATÍVEL • MONTAGEM

DES-225

DES-227

DES-1279

QUADRO PELE DE VIDRO
0,444 Kg/m
17,8 x 45 x 3,8 mm

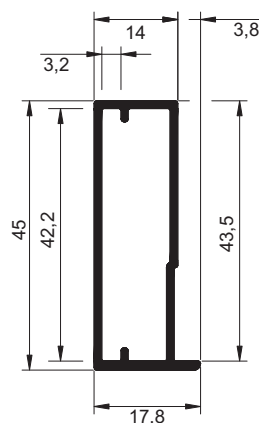

ESQUADRETA
ESQ-001



COMPATÍVEL • MONTAGEM

DES-816

DES-951

QUADRO PELE VIDRO

0,721 Kg/m

19,2 x 45 x 5 mm

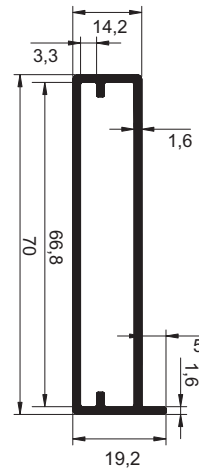

COMPATÍVEL • MONTAGEM

DES-952

COMPATÍVEL • PUXADOR

DES-145

DES-953

QUADRO PELE VIDRO

0,459 Kg/m

16,7 x 45 x 2,7 mm

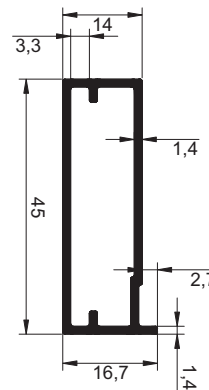

COMPATÍVEL • MONTAGEM

DES-816

ESQUADRETA
ESQ-001



DES-1073

QUADRO PELE VIDRO

0,481 Kg/m

19 x 45 x 5 mm

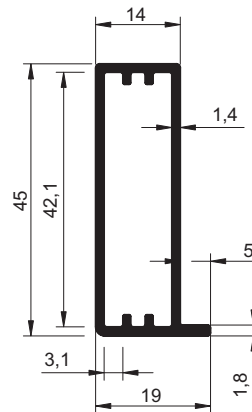

COMPATÍVEL • MONTAGEM

DES-1074

DES-1075

ESQUADRETA
ESQ-001



DES-1321

QUADRO PELE DE VIDRO

0,890 Kg/m

21,7 x 70mm

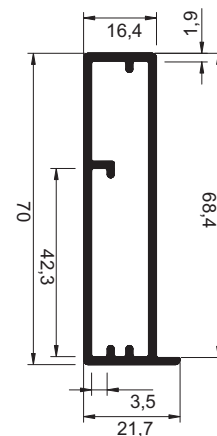

ESQUADRETA
ESQ-001



A ALUMICONTE reserva-se o direito de fazer modificações em qualquer informação escrita neste catálogo sem aviso prévio. Os desenhos aqui contidos possuem medidas teóricas de massa e tolerâncias dimensionais de acordo com a ABNT NBR-816, podendo haver variações dessas informações no produto final.

DES-1451

QUADRO PELE DE VIDRO
0,983 Kg/m
19,2 x 70,8 x 5mm



PRODUTO REFORÇADO
IDEAL PARA
PORTA DESLIZANTE

COMPATÍVEL · MONTAGEM
DES-1452
DES-1453

DES-1300

QUADRO PELE DE VIDRO
0,426 Kg/m
48,2 x 20,4 x 4,8 mm

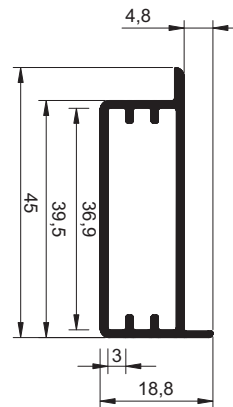

DES-1301

QUADRO PELE DE VIDRO
0,508 Kg/m
48,2 x 20,4 x 4,8 mm

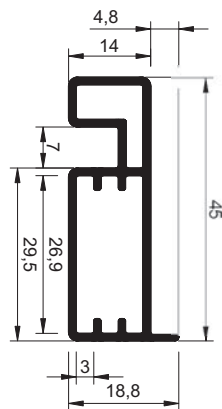

DES-1789

PERFIL QUADRO DE VIDRO PORTA REFORÇADO
1,060 Kg/m

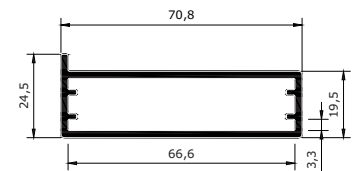

COMPATÍVEL · MONTAGEM
DES-2192
DES-2193

DES-1414

QUADRO PELE DE VIDRO
0,506 Kg/m
48,2 x 20,4 x 4,8 mm

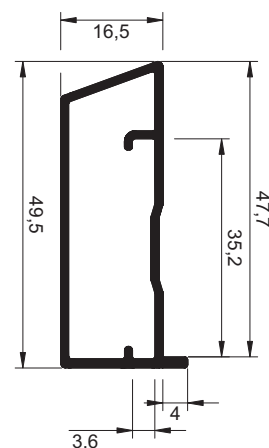

DES-1226

QUADRO VIDRO | FIXAÇÃO NÃO APARENTE

0,583 Kg/m

22,5 x 53 x 5mm

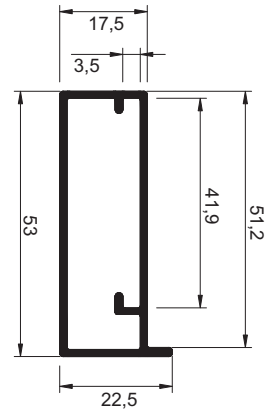

ESQUADRETA
ESQ-001



COMPATÍVEL · MONTAGEM

DES-1225

DES-1227

DES-1228

DES-1492

QUADRO PELE VIDRO

0,524 Kg/m

26 x 22,6 x 16,5mm

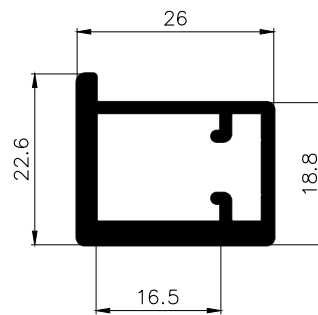

COMPATÍVEL · MONTAGEM

DES-1491

DES-1407

QUADRO PELE VIDRO

0,285 Kg/m

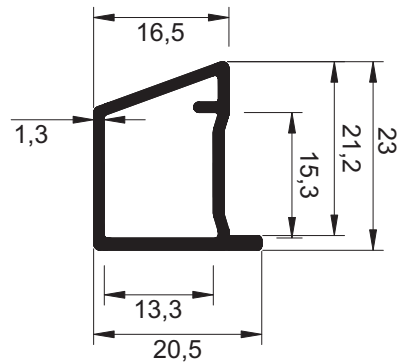

COMPATÍVEL · MONTAGEM

DES-1408

DES-912

REQUADRO VIDRO

0,552 Kg/m

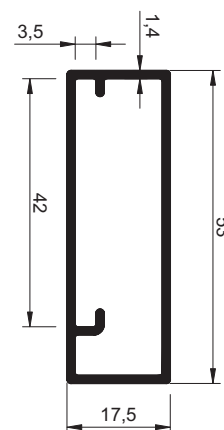

ESQUADRETA
ESQ-001



COMPATÍVEL · PUXADOR

DES-1614

A ALUMICONTE reserva-se o direito de fazer modificações em qualquer informação escrita neste catálogo sem aviso prévio. Os desenhos aqui contidos possuem medidas teóricas de massa e tolerâncias dimensionais de acordo com a ABNT NBR-8116, podendo haver variações dessas informações no produto final.

DES-1093

REQUADRO VIDRO
0,536 Kg/m
16 x 45mm

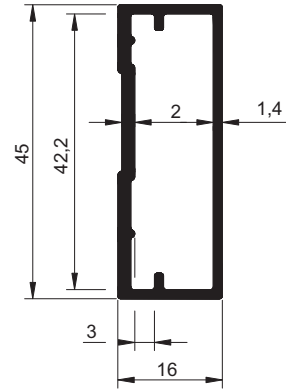

ESQUADRETA
ESQ-001



COMPATÍVEL · MONTAGEM
DES-1094

DES-1042

QUADRO VIDRO
0,562 Kg/m
45 x 17mm

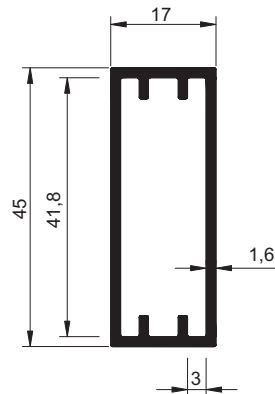

ESQUADRETA
ESQ-001



COMPATÍVEL · MONTAGEM
DES-1043

DES-2074

REQUADRO APLICAÇÃO MDF 6mm
0,516 Kg/m

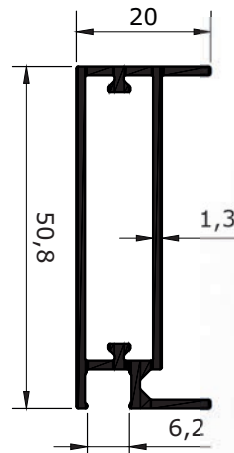
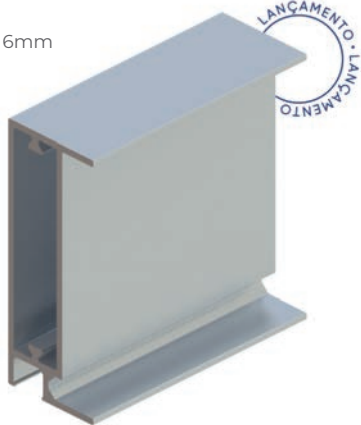

SIMULAÇÃO DE
MONTAGEM



COMPATÍVEL · MONTAGEM
DES-239
DES-1299

DES-2075

QUADRO PORTA APLICAÇÃO PARA PORCELANATO
0,488 Kg/m

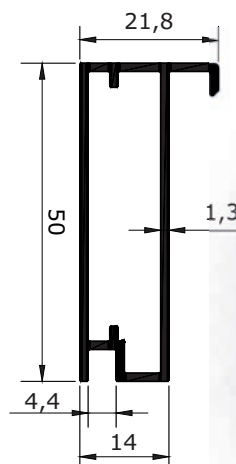
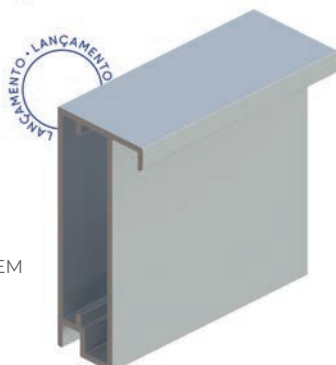

SIMULAÇÃO DE
MONTAGEM



ESQUADRETA
ESQ-001



COMPATÍVEL · MONTAGEM
DES-043
DES-112

COM PUXADOR

DES-204

QUADRO VIDRO C/ PUXADOR
0,855 Kg/m
20,3 x 78,5 x 4,5mm

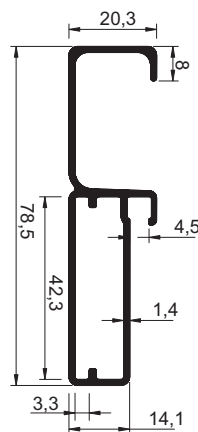

ESQUADRETA
ESQ-001



BAGUETE
BAG-007

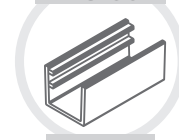

Vidro 4mm

COMPATÍVEL · MONTAGEM
DES-198

DES-551

QUADRO VIDRO C/ PUXADOR
0,727 Kg/m
18 x 80 x 4,5mm

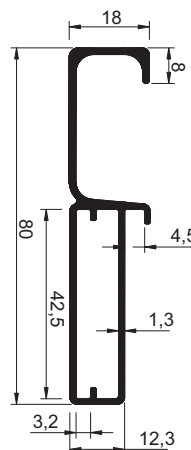

ESQUADRETA
ESQ-001



COMPATÍVEL · MONTAGEM
DES-550

DES-370

QUADRO VIDRO C/ PUXADOR
0,701 Kg/m
20 x 78,7 x 4,7mm

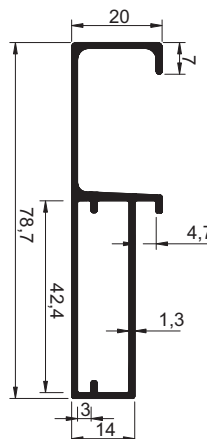

ESQUADRETA
ESQ-001

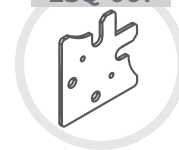

COMPATÍVEL · MONTAGEM
DES-311

DES-730

QUADRO VIDRO C/ PUXADOR
0,831 Kg/m
21,1 x 80 x 4,6mm

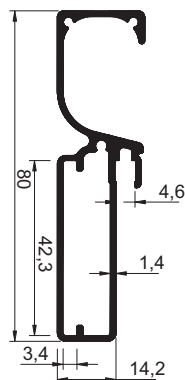

PONTES COMPATÍVEIS
BRANCO | BRONZE | CROMO
FOSCO | INOX | PRETO

ESQUADRETA
ESQ-001



BAGUETE
BAG-007



Vidro 4mm

COMPATÍVEL · MONTAGEM
DES-198

A ALUMICONTE reserva-se o direito de fazer modificações em qualquer informação escrita neste catálogo sem aviso prévio. Os desenhos aqui contidos possuem medidas teóricas de massa e tolerâncias dimensionais de acordo com a ABNT NBR-816, podendo haver variações dessas informações no produto final.

DES-282

QUADRO VIDRO C/ PUXADOR
0,800 Kg/m
20,2 x 80,1 x 4,5mm

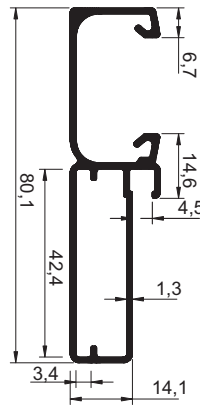
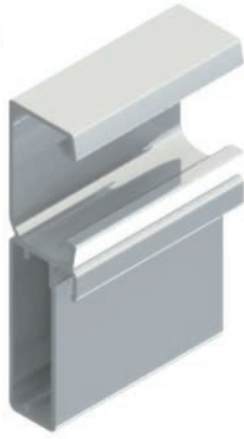

PONTEIRA COMPATÍVEL
PRETO | BRANCO | CROMO
BRONZE | FOSCO | INOX

ESQUADRETA
ESQ-001



BAGUETE
BAG-007



Vidro 4mm

COMPATÍVEL · MONTAGEM
DES-198

DES-690

QUADRO VIDRO C/ PUXADOR
0,808 Kg/m
20,2 x 78,8 x 4,3mm

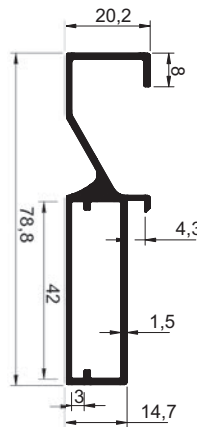

ESQUADRETA
ESQ-001



COMPATÍVEL · MONTAGEM
DES-691

DES-1403

QUADRO PELE VIDRO C/ PUXADOR
0,772 Kg/m
20,3 x 79 x 5,5mm

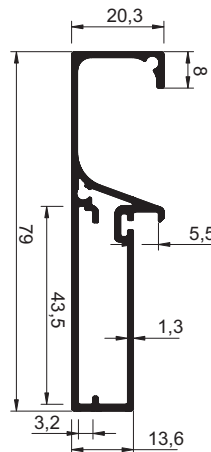

PONTEIRA COMPATÍVEL
PRETO | BRANCO | CROMO
BRONZE | FOSCO | INOX

ESQUADRETA
ESQ-001



BAGUETE
BAG-012

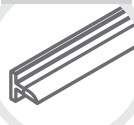

Vidro 4mm

COMPATÍVEL · MONTAGEM
DES-1402

DES-1061

QUADRO PELE VIDRO C/ PUXADOR
0,847 Kg/m
21 x 80,3 x 5,5mm

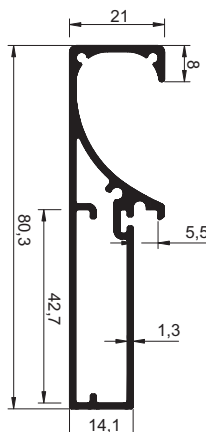

PONTEIRA COMPATÍVEL
PRETO | BRANCO | CROMO
BRONZE | FOSCO | INOX

ESQUADRETA
ESQ-001



BAGUETE
BAG-012



Vidro 4mm

COMPATÍVEL · MONTAGEM
DES-1060

DES-930

QUADRO VIDRO C/ PUXADOR
0,886 Kg/m
20,5 x 77,6 x 6,7mm

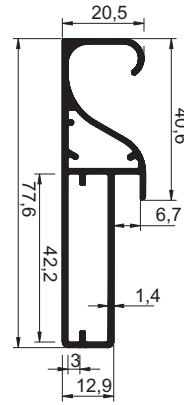

ESQUADRETA
ESQ-001



BAGUETE
BAG-010

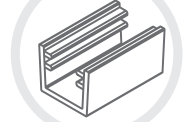

Vidro 4mm

COMPATÍVEL · MONTAGEM
DES-929

DES-950

QUADRO VIDRO C/ PUXADOR
0,801 Kg/m
20,2 x 78,8 x 4,5mm

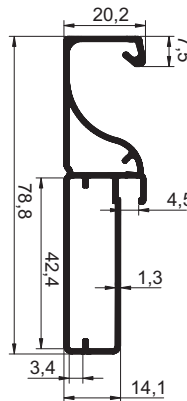

PONTAIRA COMPATÍVEL
PRETO | BRANCO | CROMO
BRONZE | FOSCO | INOX

ESQUADRETA
ESQ-001



BAGUETE
BAG-007



Vidro 4mm

COMPATÍVEL · MONTAGEM
DES-198

DES-1014

QUADRO PELE VIDRO C/ PUXADOR
0,923 Kg/m
20,2 x 82,1 x 5,2mm

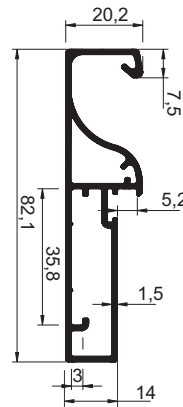

COMPATÍVEL · MONTAGEM
DES-854

DES-1268

QUADRO VIDRO C/ PUXADOR
0,754 Kg/m
20,3 x 78,6 x 4,5mm

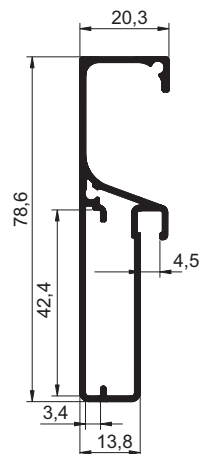

ESQUADRETA
ESQ-001



BAGUETE
BAG-007



Vidro 4mm

COMPATÍVEL · MONTAGEM
DES-1264

A ALUMICONTE reserva-se o direito de fazer modificações em qualquer informação escrita neste catálogo sem aviso prévio. Os desenhos aqui contidos possuem medidas teóricas de massa e tolerâncias dimensionais de acordo com a ABNT NBR-816, podendo haver variações dessas informações no produto final.

DES-1610

QUADRO VIDRO C/ PUXADOR
0,741 Kg/m

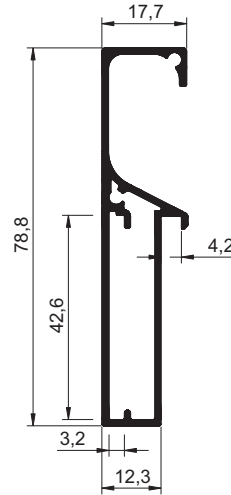

ESQUADRETA
ESQ-001



DES-1419

QUADRO VIDRO C/ PUXADOR
0,809 Kg/m

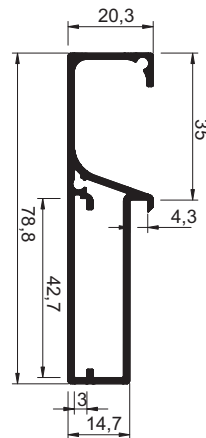

PONTEIRA COMPATÍVEL

PRETO | BRANCO | CROMO
BRONZE | FOSCO | INOX



ESQUADRETA
ESQ-001



DES-076

QUADRO VIDRO C/ PUXADOR
0,578 Kg/m
34,5 x 45 x 4,7mm

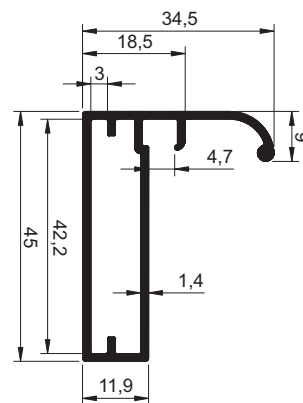

ESQUADRETA
ESQ-001



BAGUETE
BAG-008



Vidro 4mm

COMPATÍVEL · MONTAGEM
DES-077

DES-158

QUADRO VIDRO C/ PUXADOR
0,563 Kg/m
36,8 x 45 x 5,2mm

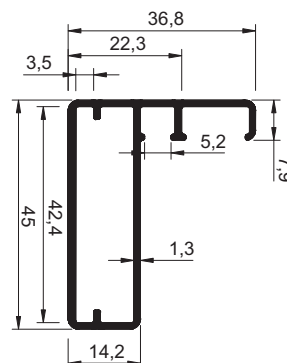

ESQUADRETA
ESQ-001



BAGUETE
BAG-008



Vidro 4mm

COMPATÍVEL · MONTAGEM
DES-001

DES-877

QUADRO VIDRO C/ PUXADOR
0,524 Kg/m
33,6 x 45 x 4,5mm

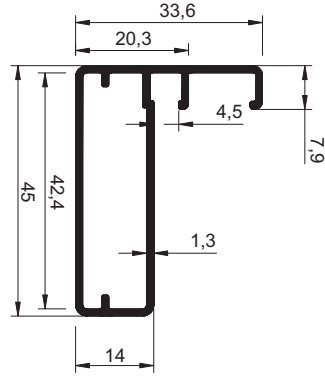

ESQUADRETA
ESQ-001

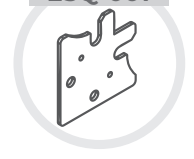

BAGUETE
BAG-007



Vidro 4mm

COMPATÍVEL · MONTAGEM
DES-198

DES-692

QUADRO VIDRO C/ PUXADOR
0,619 Kg/m
33,2 x 45 x 4,3mm

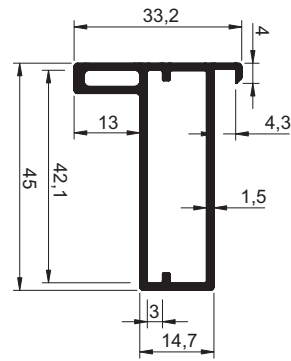

ESQUADRETA
ESQ-001



COMPATÍVEL · MONTAGEM
DES-691

DES-1489

REQUADRO VIDRO C/ PUXADOR
0,684 Kg/m
26 x 40 x 4,8mm

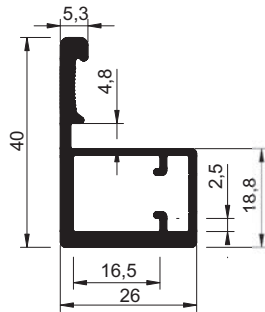

COMPATÍVEL · MONTAGEM
DES-1490

DES-2192

QUADRO VIDRO C/ PUXADOR
1,175 Kg/m

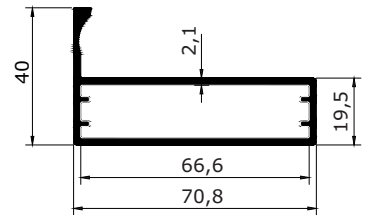
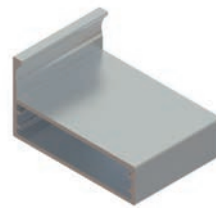

COMPATÍVEL · MONTAGEM
DES-1789
DES-2193

DES-313

QUADRO VIDRO C/ PUXADOR
0,574 Kg/m

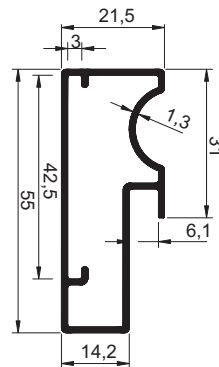

ESQUADRETA
ESQ-001



BAGUETE
BAG-009

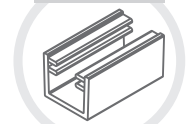

Vidro 4mm

DES-320

QUADRO VIDRO C/ PUXADOR

0,566 Kg/m

21,5 x 55 x 6,1mm

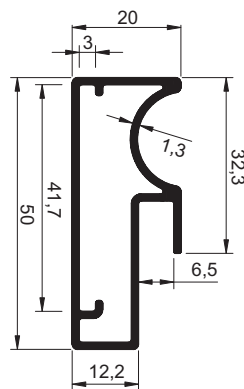

ESQUADRETA
ESQ-001



BAGUETE
BAG-010

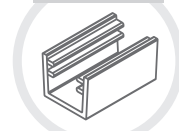

Vidro 4mm

DES-897

QUADRO VIDRO C/ PUXADOR

0,681 Kg/m

20,3 x 66 x 4,5mm

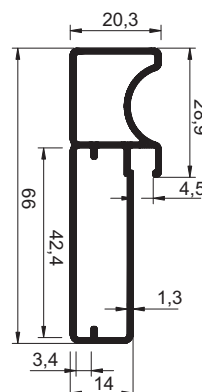

ESQUADRETA
ESQ-001



BAGUETE
BAG-007



Vidro 4mm

COMPATÍVEL · MONTAGEM
DES-198

DES-012

QUADRO VIDRO C/ PUXADOR

0,558 Kg/m

20 x 44,8 x 5,2mm

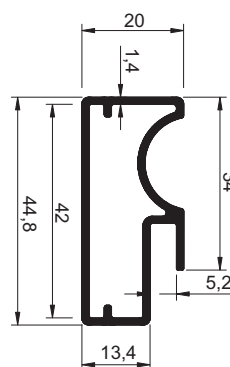

ESQUADRETA
ESQ-001



BAGUETE
BAG-007



Vidro 4mm

DES-940

QUADRO VIDRO C/ PUXADOR

0,857 Kg/m

22 x 70 x 6,2mm

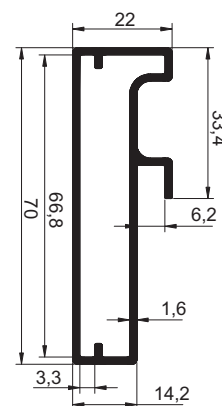

BAGUETE
BAG-009

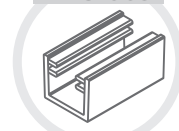

Vidro 4mm

DES-1265

QUADRO VIDRO C/ PUXADOR

0,505 Kg/m

20 x 44,8 x 4,5mm

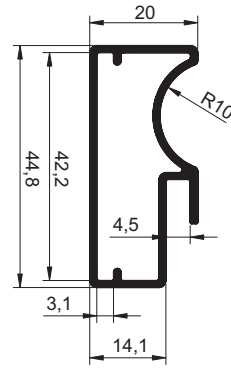
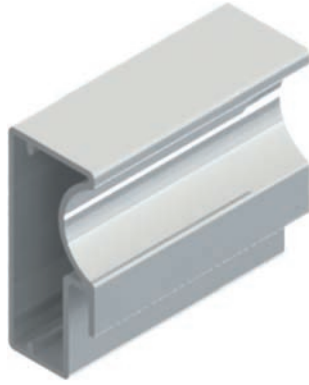

ESQUADRETA
ESQ-001



DES-011

QUADRO VIDRO C/ PUXADOR

0,668 Kg/m

22,5 x 60 x 6,2mm

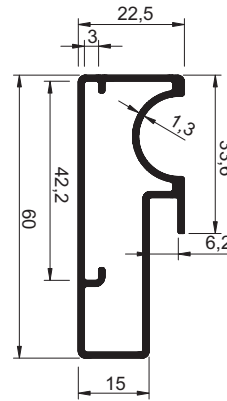

BAGUETE
BAG-009



Vidro 4mm

COMPATÍVEL · MONTAGEM

DES-168

DES-868

DES-1012

QUADRO VIDRO C/ PUXADOR

0,486 Kg/m

20,2 x 45 x 5mm

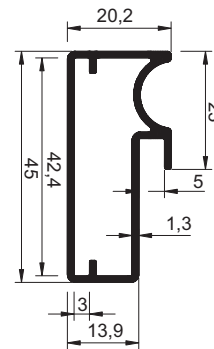

ESQUADRETA
ESQ-001



BAGUETE
BAG-007



Vidro 4mm

DES-026

QUADRO VIDRO C/ PUXADOR

0,453 Kg/m

21 x 31,4 x 6mm

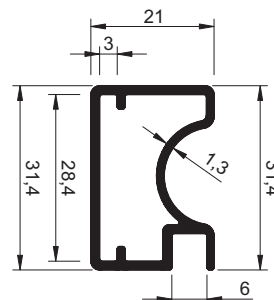

BAGUETE
BAG-009



Vidro 4mm

DES-187

QUADRO VIDRO C/ PUXADOR

0,635 Kg/m

20 x 60 x 4mm

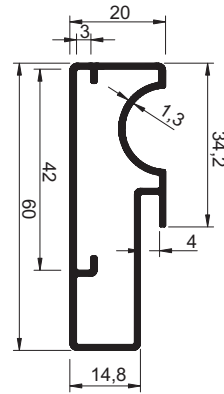

ESQUADRETA
ESQ-001



DES-078

QUADRO VIDRO C/ PUXADOR

0,520 Kg/m

22,3 x 45 x 6,5mm

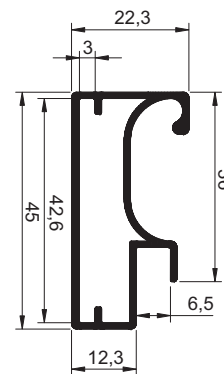

ESQUADRETA
ESQ-001



BAGUETE
BAG-010



Vidro 4mm

DES-193

QUADRO VIDRO C/ PUXADOR

0,578 Kg/m

20 x 60 x 6mm

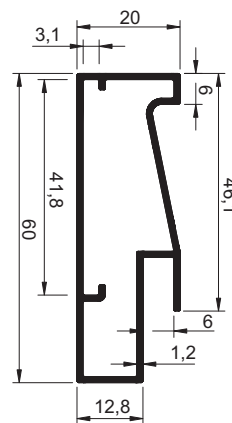

ESQUADRETA
ESQ-001



BAGUETE
BAG-009



Vidro 4mm

DES-279

QUADRO VIDRO C/ PUXADOR

0,523 Kg/m

22 x 45 x 6,2mm

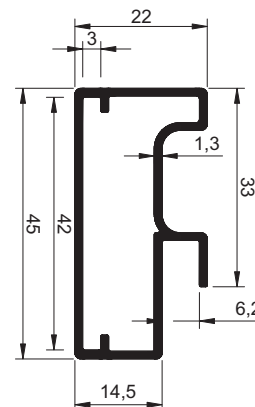

ESQUADRETA
ESQ-001



BAGUETE
BAG-009

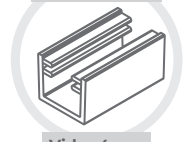

Vidro 4mm

DES-301

QUADRO VIDRO C/ PUXADOR

0,401 Kg/m

20 x 31,8 x 6mm

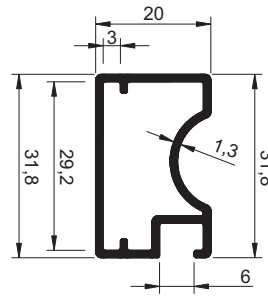

DES-362

QUADRO VIDRO C/ PUXADOR

0,400 Kg/m

20 x 35 x 6,1mm

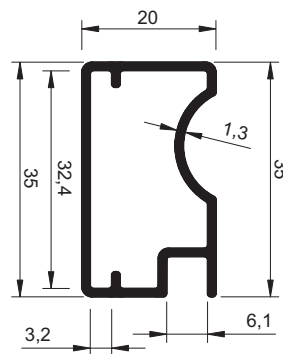

DES-1043

REQUADRO VIDRO C/ PUXADOR

0,939 Kg/m

17 x 80mm

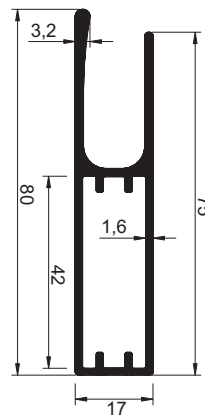

COMPATÍVEL · MONTAGEM

DES-1042

DES-1094

QUADRO PELE VIDRO C/ PUXADOR

0,879 Kg/m

16 x 80mm

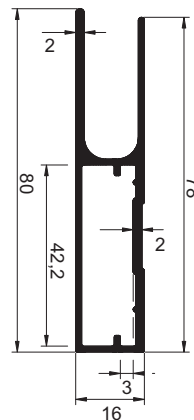

COMPATÍVEL · MONTAGEM

DES-1093

A ALUMICONTE reserva-se o direito de fazer modificações em qualquer informação escrita neste catálogo sem aviso prévio. Os desenhos aqui contidos possuem medidas teóricas de massa e tolerâncias dimensionais de acordo com a ABNT NBR-8116, podendo haver variações dessas informações no produto final.

DES-1225

QUADRO VIDRO C/ PUXADOR
SEM FIXAÇÃO APARENTE

0,676 Kg/m
22,5 x 68 x 3,5mm

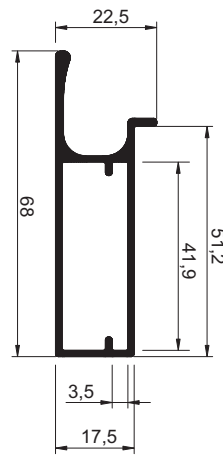

PONTEIRA COMPATÍVEL

BRONZE | FOSCO | INOX



ESQUADRETA
ESQ-001



COMPATÍVEL • MONTAGEM

DES-1226

DES-1227

DES-225

QUADRO PELE VIDRO C/ PUXADOR

0,698 Kg/m
17,5 X 68 x 3,5mm

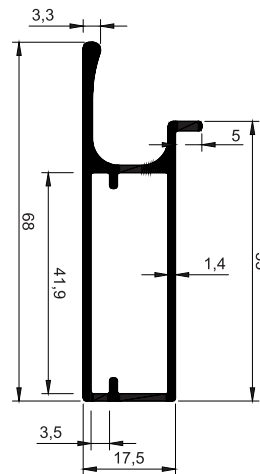

PONTEIRA COMPATÍVEL

BRONZE | FOSCO | INOX



ESQUADRETA
ESQ-001



COMPATÍVEL • MONTAGEM

DES-226

DES-227

DES-227

QUADRO PELE VIDRO C/ PUXADOR

0,608 Kg/m
22,5 x 53 x 5mm

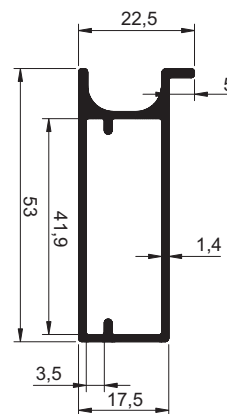

PONTEIRA COMPATÍVEL

BRONZE | FOSCO | INOX



ESQUADRETA
ESQ-001



COMPATÍVEL • MONTAGEM

DES-225

DES-226

DES-1227

QUADRO VIDRO C/ PUXADOR
FIXAÇÃO NÃO APARENTE

0,633 Kg/m
22,5 x 53 x 5mm

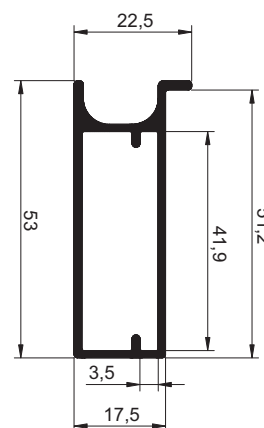

PONTEIRA COMPATÍVEL

BRONZE | FOSCO | INOX



ESQUADRETA
ESQ-001



COMPATÍVEL • MONTAGEM

DES-1225

DES-1226

DES-1228

DES-1228

QUADRO VIDRO C/ PUXADOR
0,862 Kg/m
22,5 x 80 x 5mm

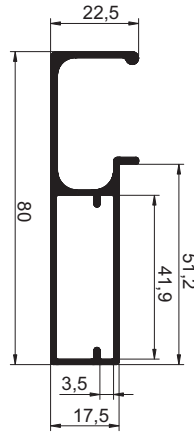

PONTEIRA COMPATÍVEL
BRONZE | FOSCO | INOX



ESQUADRETA
ESQ-001



COMPATÍVEL · MONTAGEM
DES-1226
DES-1227

DES-1271

QUADRO VIDRO C/ PUXADOR
0,862 Kg/m
22,5 x 80 x 5mm

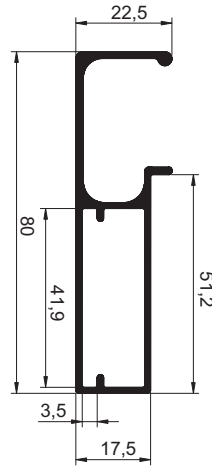

PONTEIRA COMPATÍVEL
BRONZE | FOSCO | INOX

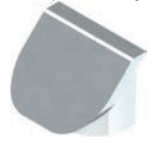

ESQUADRETA
ESQ-001



COMPATÍVEL · MONTAGEM
DES-226
DES-225
DES-227

DES-1074

QUADRO PELE VIDRO C/ PUXADOR
0,628 Kg/m
35 x 45 x 5mm

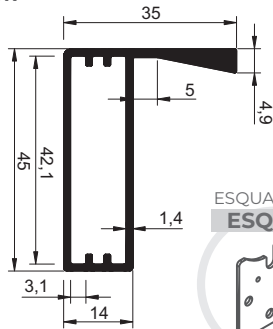

ESQUADRETA
ESQ-001



COMPATÍVEL · MONTAGEM
DES-1073 | DES-1075

DES-1491

QUADRO VIDRO C/ PUXADOR
0,644 Kg/m
26 x 40mm

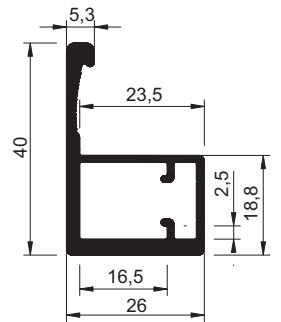
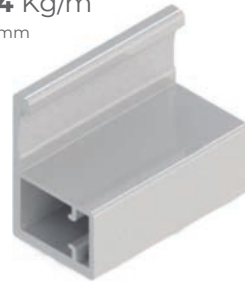

COMPATÍVEL · MONTAGEM
DES-1492

DES-1408

QUADRO VIDRO C/ PUXADOR
0,704 Kg/m

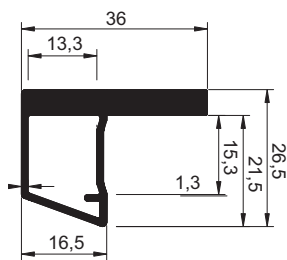

COMPATÍVEL · MONTAGEM
DES-1407

DES-1697

QUADRO VIDRO C/ PUXADOR
0,599 Kg/m

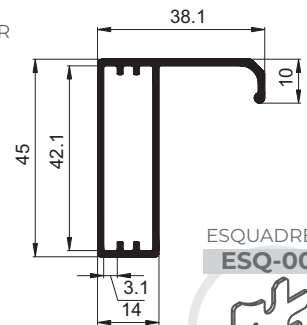

ESQUADRETA
ESQ-001



A ALUMICONTE reserva-se o direito de fazer modificações em qualquer informação escrita neste catálogo sem aviso prévio. Os desenhos aqui contidos possuem medidas teóricas de massa e tolerâncias dimensionais de acordo com a ABNT NBR-816, podendo haver variações dessas informações no produto final.

TRAVESSA

DES-1453

TRAVESSA QUADRO VIDRO

0,476 Kg/m

27 x 19,2 x 5mm

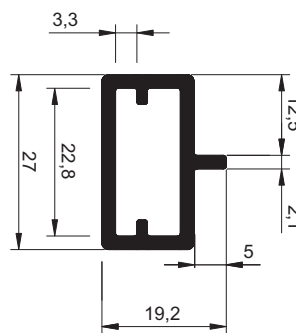

PRODUTO REFORÇADO
IDEAL PARA
PORTA DESLIZANTE

COMPATÍVEL · MONTAGEM

DES-1451

DES-1452

DES-168

TRAVESSA QUADRO VIDRO

0,482 Kg/m

22,5 x 20 x 6,1mm

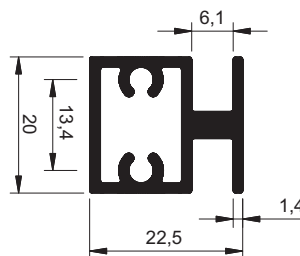
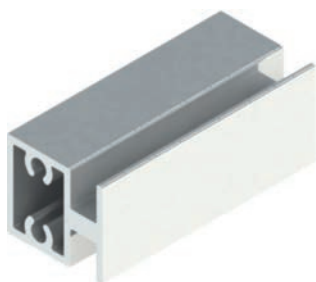

BAGUETE
BAG-009
Vidro 4mm

COMPATÍVEL · MONTAGEM

DES-011

DES-247

TRAVESSA QUADRO VIDRO

0,262 Kg/m

18,5 x 20 x 6 mm

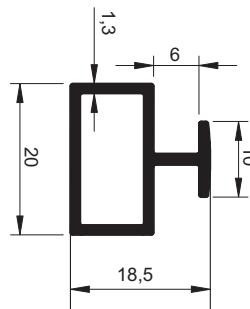

BAGUETE
BAG-009
Vidro 4mm

DES-952

TRAVESSA QUADRO VIDRO

0,317 Kg/m

13,9 x 27 x 5 mm

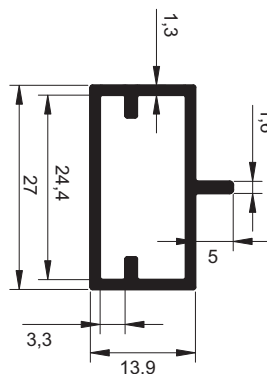

COMPATÍVEL · MONTAGEM

DES-951

DES-1017

TRAVESSA QUADRO VIDRO

0,330 Kg/m

20 x 22,1 x 5,2 mm

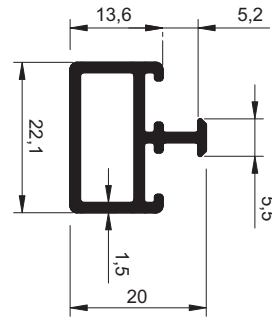

COMPATÍVEL · MONTAGEM
DES-1403

DES-1075

TRAVESSA INTERMEDIÁRIA

0,469 Kg/m

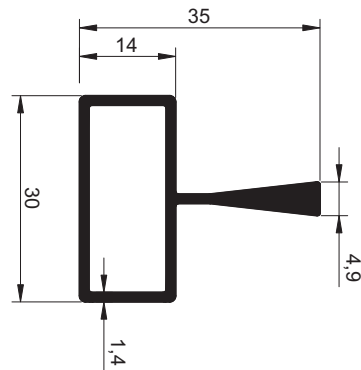
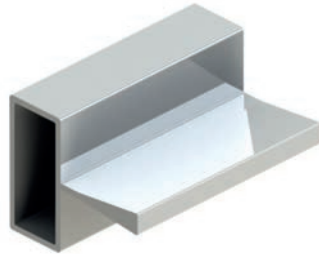

DES-1297

TRAVESSA OCULTA

0,500 Kg/m

40 x 23,6 mm

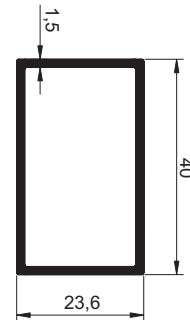
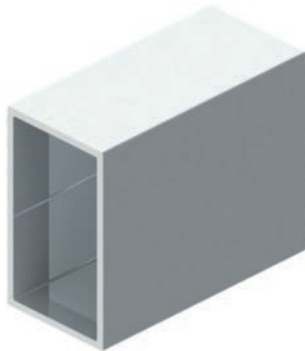

COMPATÍVEL · MONTAGEM
DES-600

DES-077

TRAVESSA QUADRO VIDRO

0,160 Kg/m

11,9 x 11,9 mm

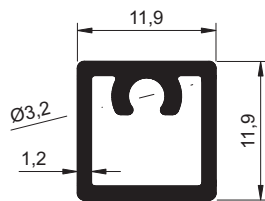

COMPATÍVEL · MONTAGEM
DES-076

BXT-505

FIXAÇÃO TRAVESSA

0,467 Kg/m

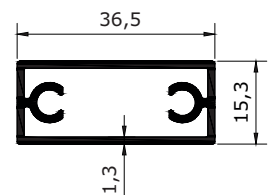
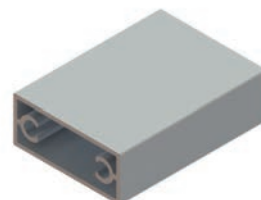

DES-856

TRAVESSA QUADRO VIDRO

0,196 Kg/m

14 x 16,8mm

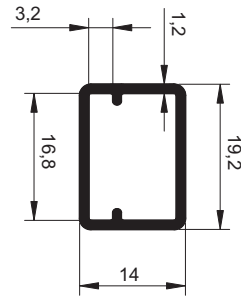

DES-1016

TRAVESSA QUADRO VIDRO

0,232 Kg/m

13,6 x 20mm

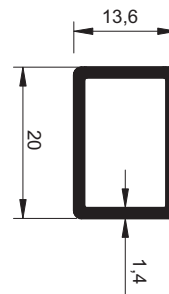

COMPATÍVEL · MONTAGEM

DES-1403

DES-868

QUADRO VIDRO DUPLO

0,533 Kg/m

22,5 x 41 x 7,4mm

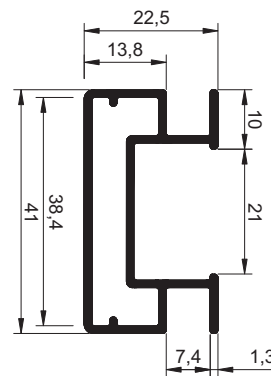

BAGUETE
BAG-013

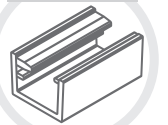

Vidro 4mm

DES-1044

REQUADRO VIDRO C/ PUXADOR

0,732 Kg/m

48 x 18mm

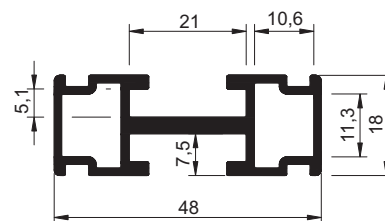



PERFIL PARA TRILHO DE CORRER

Perfis responsáveis por dar base e
auxiliar no direcionamento
e funcionamento eficiente de
portas de correr.



DES-036

TRILHO SUPERIOR SIMPLES

0,583 Kg/m

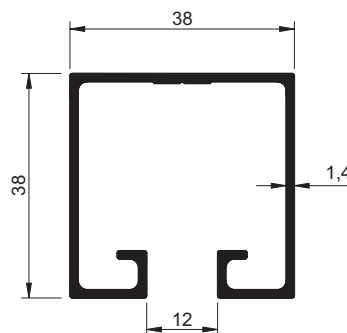
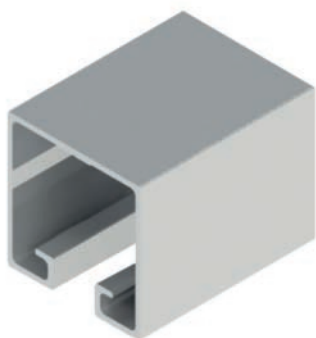

DES-037

TRILHO SUPERIOR SIMPLES (ROLDANA CÔNCAVA)

0,501 Kg/m

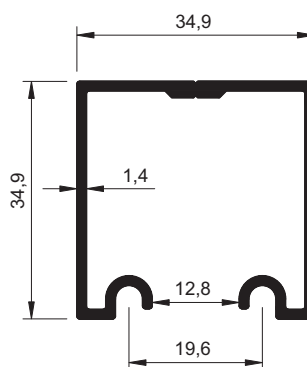

DES-044

TRILHO SUPERIOR SIMPLES (ROLDANA CÔNCAVA)

0,494 Kg/m

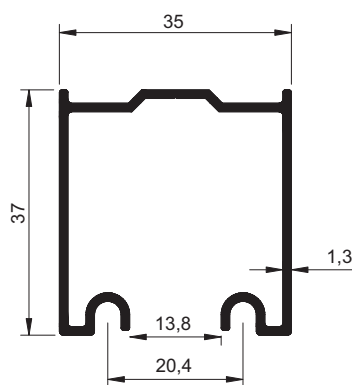

DES-200

TRILHO SUPERIOR SIMPLES (ROLDANA CÔNCAVA)

0,577 Kg/m

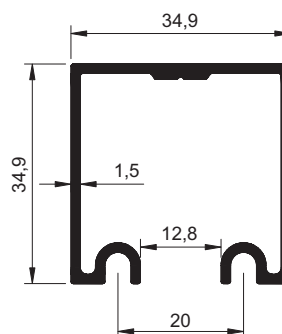
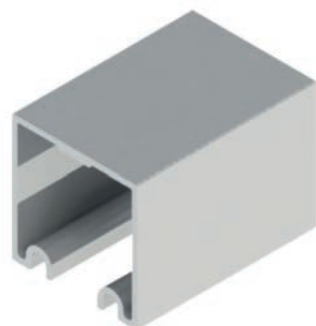

A ALUMICONTE reserva-se o direito de fazer modificações em qualquer informação escrita neste catálogo sem aviso prévio. Os desenhos aqui contidos possuem medidas teóricas de massa e tolerâncias dimensionais de acordo com a ABNT NBR-8116, podendo haver variações dessas informações no produto final.

DES-261

TRILHO SUPERIOR SIMPLES C/ ENCAIXE BANDEIRA

0,623 Kg/m

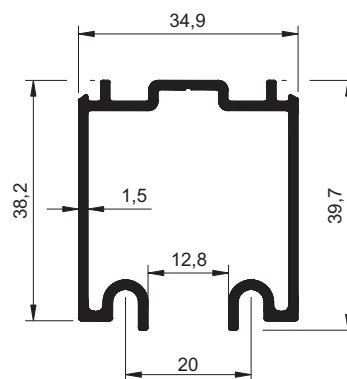
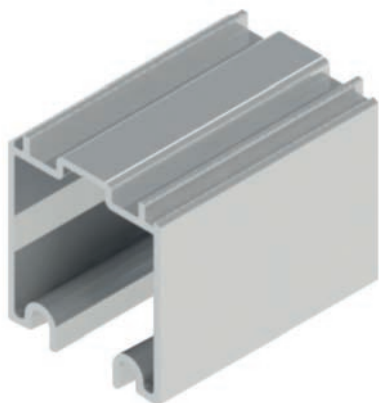

COMPATÍVEL · MONTAGEM

DES-262

DES-262

CAPA TRILHO SUPERIOR (DES-261 -DES-273)

0,306 Kg/m

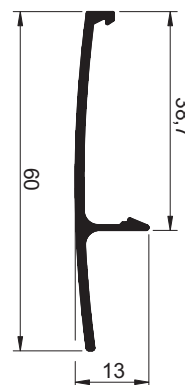
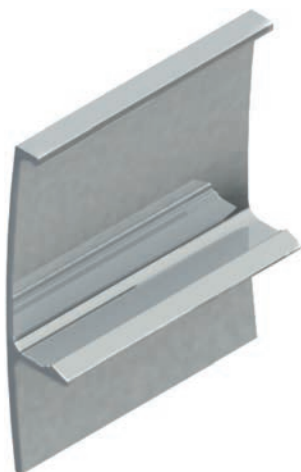

COMPATÍVEL · MONTAGEM

DES-261

DES-273

DES-167

TRILHO SUPERIOR SIMPLES (ROLDANA CONVEXA)

0,431 Kg/m

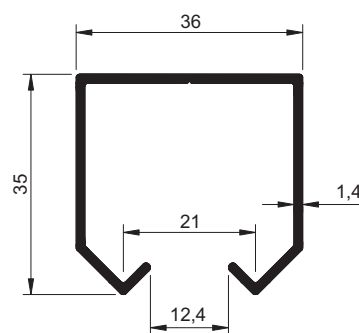
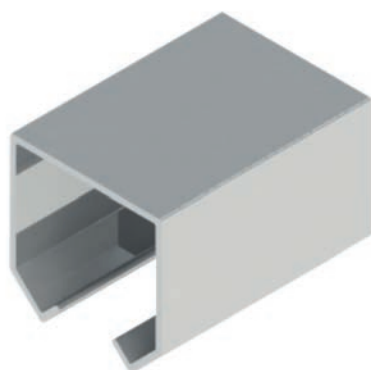

DES-039

TRILHO SUPERIOR SIMPLES (ROLDANA CONVEXA)

0,432 Kg/m

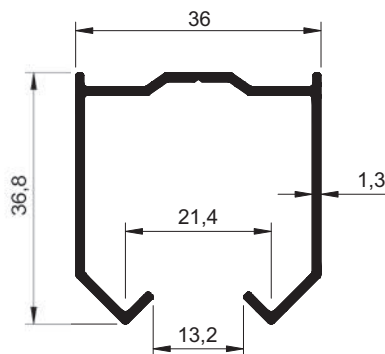
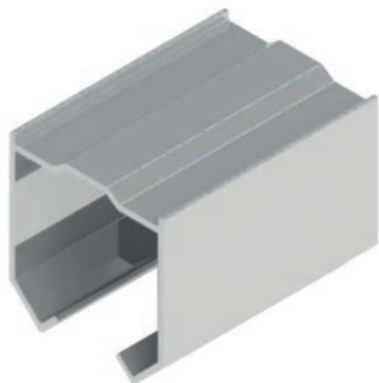

DES-886

TRILHO SUPERIOR SIMPLES (ROLDANA CONVEXA)

0,572 Kg/m

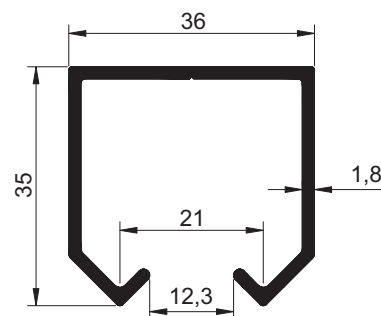
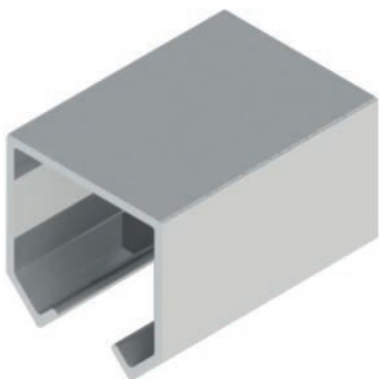

DES-035

TRILHO SUPERIOR SIMPLES

0,387 Kg/m

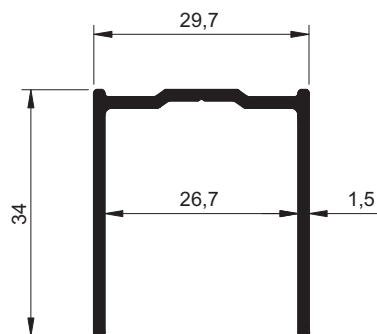

DES-944

TRILHO SUPERIOR SIMPLES
0,317 Kg/m

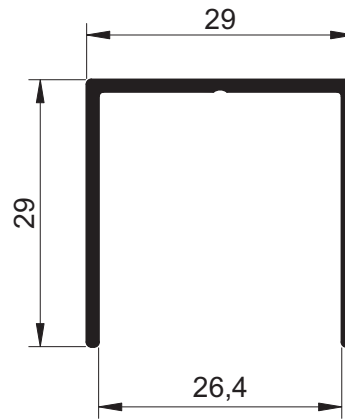
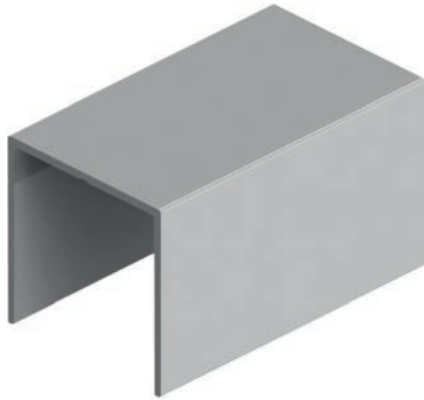

DES-380

TRILHO SUPERIOR SIMPLES C/ ENCAIXE FREIO
0,546 Kg/m

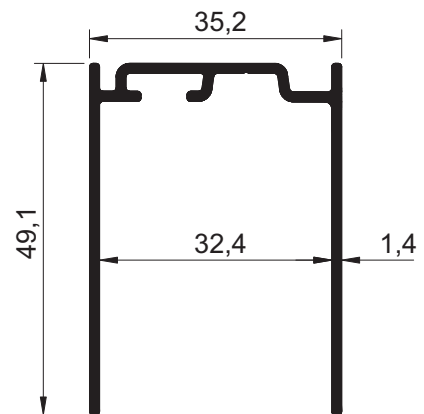

DES-1433

TRILHO SUPERIOR SIMPLES
0,545 Kg/m

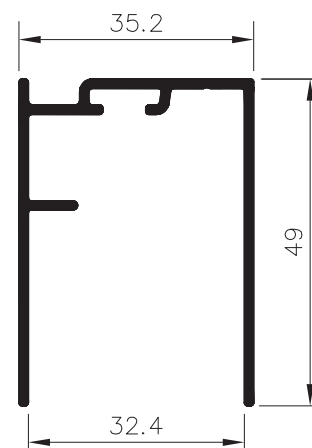

DES-980

TRILHO SUPERIOR SIMPLES
0,301 Kg/m

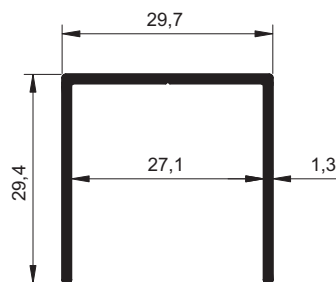

DES-992

TRILHO SUPERIOR SIMPLES
0,249 Kg/m

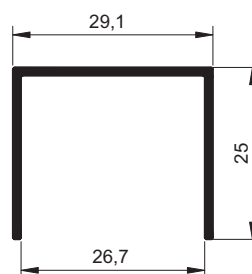

DES-273

SUPERIOR DUPLO C/ ENCAIXE BANDEIRA
1,103 Kg/m

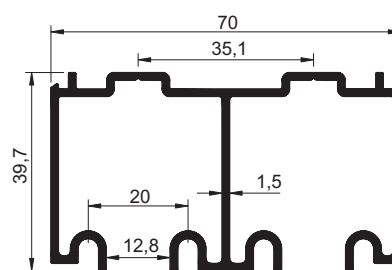
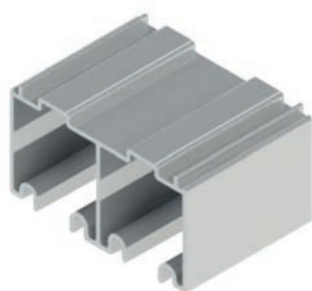

COMPATÍVEL • MONTAGEM
DES-262

DES-038

TRILHO SUPERIOR DUPLO
0,492 Kg/m

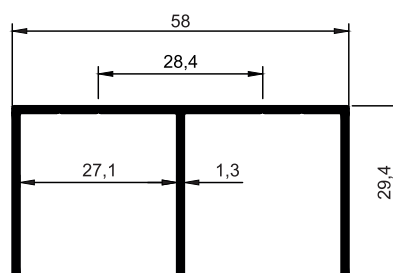

COMPATÍVEL • MONTAGEM
DES-512
DES-049
DES-294
DES-058
DES-113

A ALUMICONTE reserva-se o direito de fazer modificações em qualquer informação escrita neste catálogo sem aviso prévio. Os desenhos aqui contidos possuem medidas teóricas de massa e tolerâncias dimensionais de acordo com a ABNT NBR-8116, podendo haver variações dessas informações no produto final.

DES-156

TRILHO SUPERIOR DUPLO
0,435 Kg/m

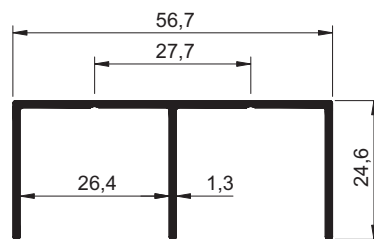

DES-269

TRILHO SUPERIOR DUPLO C/ ABA CONVEXA
0,729 Kg/m

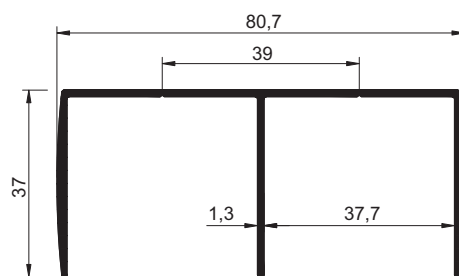

COMPATÍVEL • MONTAGEM

- DES-907
- DES-824
- DES-051
- DES-228

DES-390

TRILHO SUPERIOR DUPLO
0,441 Kg/m

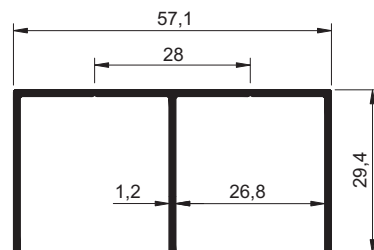

COMPATÍVEL • MONTAGEM

- DES-049
- DES-512
- DES-058
- DES-113
- DES-294

DES-032

TRILHO SUPERIOR DUPLO
0,665 Kg/m

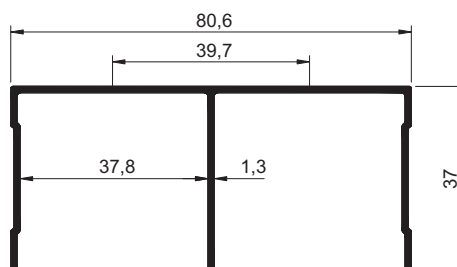
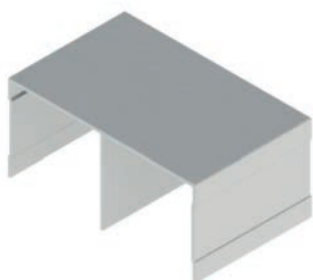

COMPATÍVEL • MONTAGEM

- DES-824
- DES-051
- DES-228
- DES-907

DES-287

TRILHO SUPERIOR DUPLO C/ ABA CONVEXA

0,589 Kg/m

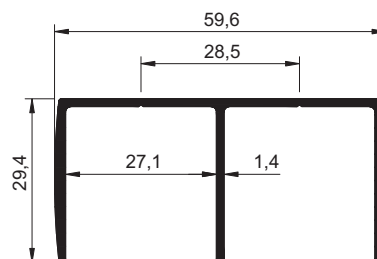

COMPATÍVEL • MONTAGEM

DES-512

DES-294

DES-058

DES-113

DES-049

DES-340

TRILHO SUPERIOR DUPLO (ROLDANA CONVEXA)

0,615 Kg/m

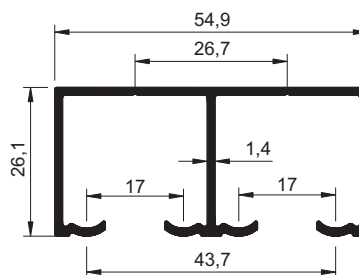
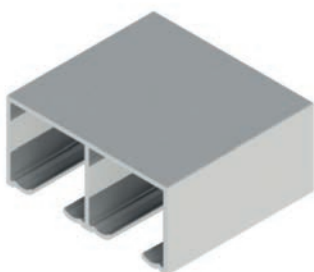

DES-379

TRILHO SUP. TRIPLO/DUPLO (ROLDANA CONVEXA)

0,751 Kg/m

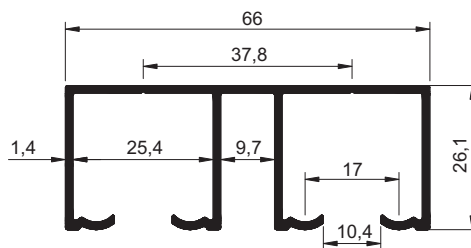
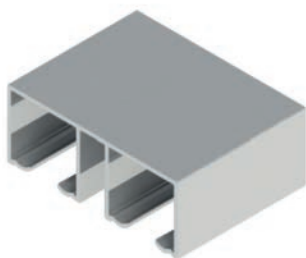

DES-050A

TRILHO SUPERIOR DUPLO S/ ABA FRONTAL

0,390 Kg/m

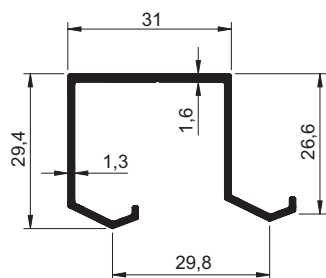
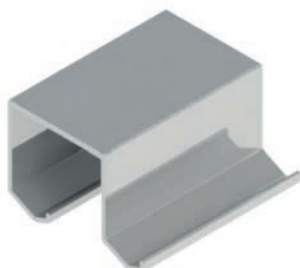

DES-169

CAPA TRILHO SUPERIOR

0,273 Kg/m

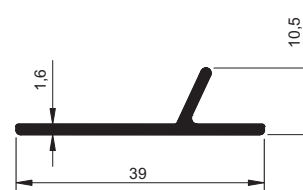
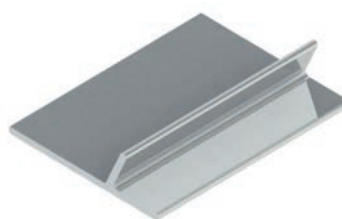

A ALUMICONTE reserva-se o direito de fazer modificações em qualquer informação escrita neste catálogo sem aviso prévio. Os desenhos aqui contidos possuem medidas teóricas de massa e tolerâncias dimensionais de acordo com a ABNT NBR-8116, podendo haver variações dessas informações no produto final.

DES-480

TRILHO SUPERIOR DUPLO C/ ENCAIXE FREIO

0,894 Kg/m



COMPATÍVEL • MONTAGEM

DES-344

DES-603

DES-843

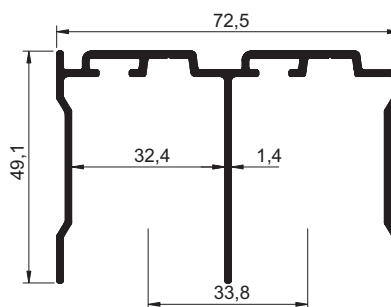

DES-1434

TRILHO SUPERIOR DUPLO

0,910Kg/m

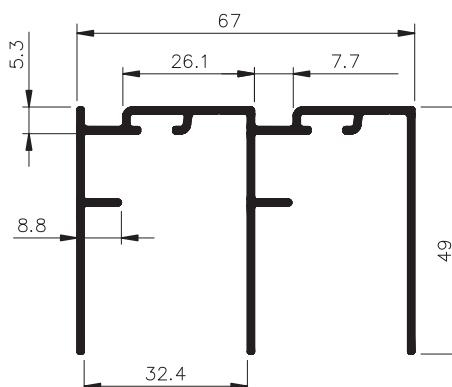
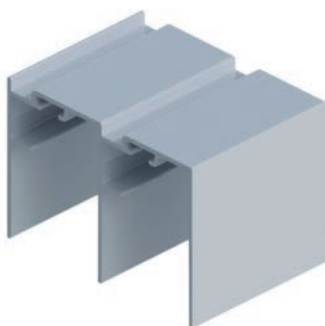

DES-511

TRILHO SUPERIOR DUPLO C/ ENCAIXE LÂMINA

0,465 Kg/m

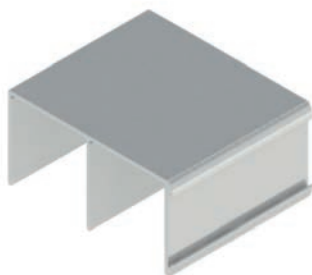

COMPATÍVEL • MONTAGEM

DES-058

DES-113

DES-294

DES-512

DES-049

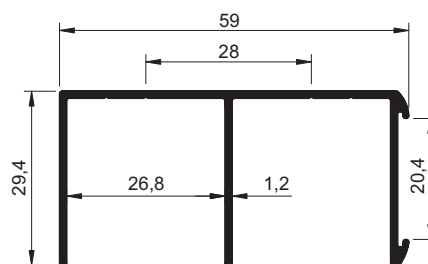

DES-524

TRILHO SUPERIOR DUPLO

0,393 Kg/m



COMPATÍVEL • MONTAGEM

DES-049

DES-058

DES-113

DES-294

DES-512

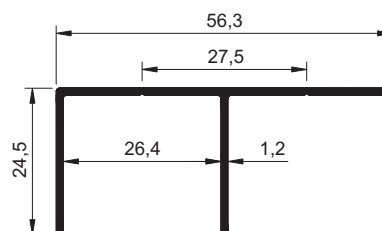

DES-601

TRILHO SUPERIOR DUPLO
0,550 Kg/m

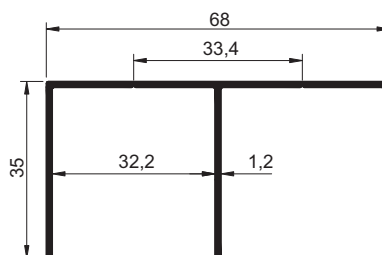

COMPATÍVEL • MONTAGEM

DES-344
DES-603
DES-843

DES-813

TRILHO SUPERIOR DUPLO
0,690 Kg/m

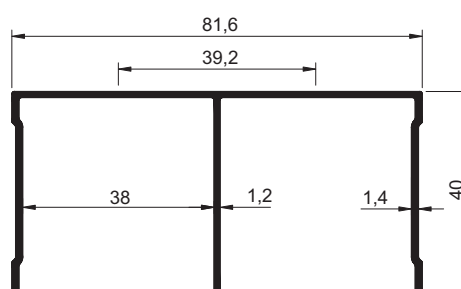
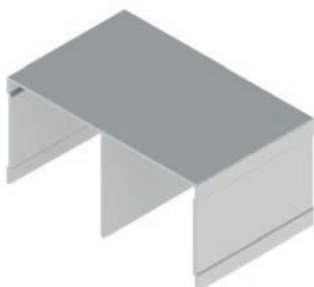

COMPATÍVEL • MONTAGEM

DES-051
DES-228
DES-824
DES-907

DES-844

TRILHO SUPERIOR DUPLO
0,461 Kg/m

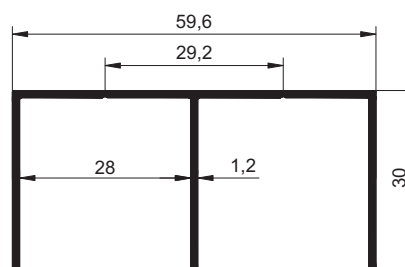

COMPATÍVEL • MONTAGEM

DES-1284
DES-188
DES-042
DES-287

DES-906

TRILHO SUPERIOR DUPLO C/ ENCAIXE FREIO
0,742 Kg/m

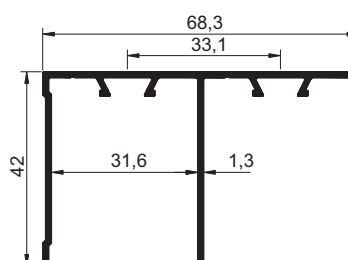
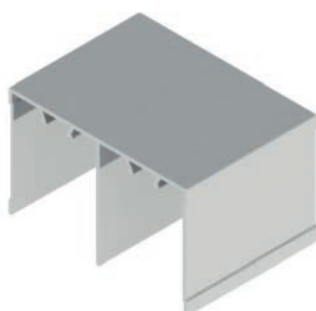

COMPATÍVEL • MONTAGEM

DES-1344
DES-603
DES-843

DES-1274

TRILHO SUPERIOR DUPLO - SISTEMA SUSPENSO

0,513 Kg/m

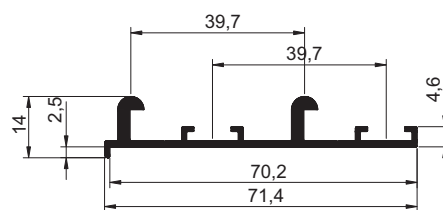

COMPATÍVEL • MONTAGEM

DES-1275



DES-041

TRILHO INFERIOR SIMPLES
0,124 Kg/m

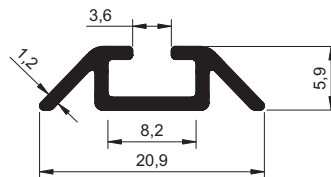
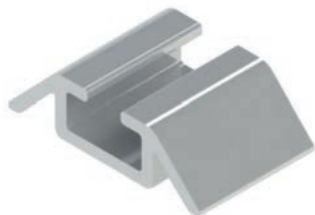

DES-055

TRILHO INFERIOR SIMPLES DE EMBUTIR
0,088 Kg/m

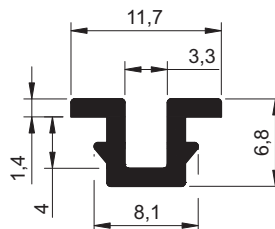

DES-155

TRILHO INFERIOR SIMPLES
0,085 Kg/m

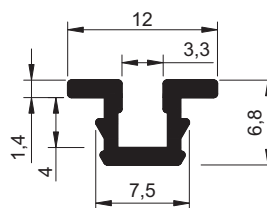

DES-315

TRILHO INFERIOR SIMPLES DE EMBUTIR
0,110 Kg/m

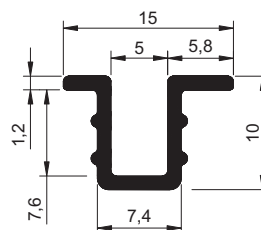

A ALUMICONTE reserva-se o direito de fazer modificações em qualquer informação escrita neste catálogo sem aviso prévio. Os desenhos aqui contidos possuem medidas teóricas de massa e tolerâncias dimensionais de acordo com a ABNT NBR-8116, podendo haver variações dessas informações no produto final.

DES-042

TRILHO INFERIOR DUPLO

0,235 Kg/m

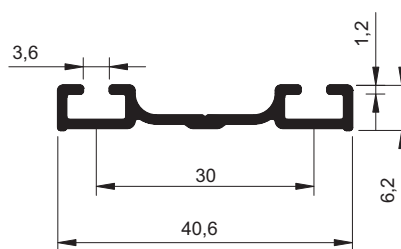

COMPATÍVEL • MONTAGEM
DES-844

DES-113

TRILHO INFERIOR DUPLO

0,232 Kg/m

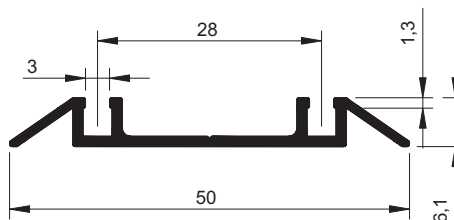
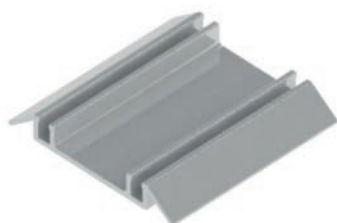

COMPATÍVEL • MONTAGEM
DES-524
DES-511
DES-038
DES-287
DES-390

DES-294

TRILHO INFERIOR DUPLO

0,275 Kg/m

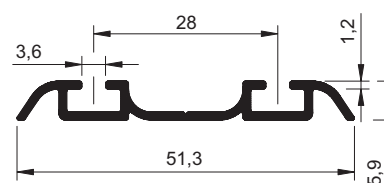
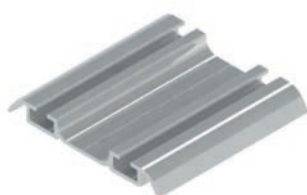

COMPATÍVEL • MONTAGEM
DES-524
DES-511
DES-038
DES-287
DES-390

DES-512

TRILHO INFERIOR DUPLO

0,231 Kg/m

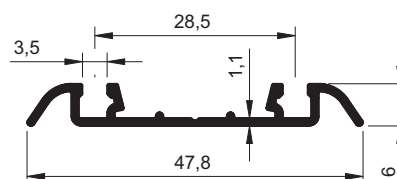
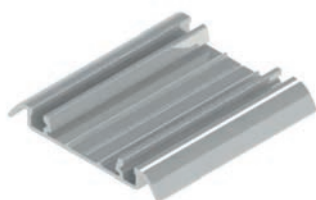

COMPATÍVEL • MONTAGEM
DES-390
DES-524
DES-511
DES-038
DES-287

DES-188

TRILHO INFERIOR DUPLO
0,337 Kg/m

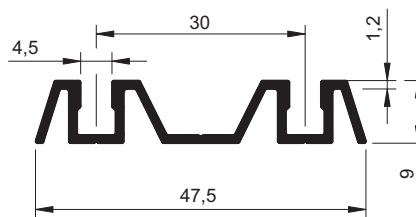

COMPATÍVEL · MONTAGEM
DES-844

DES-309

TRILHO INFERIOR DUPLO
0,267 Kg/m

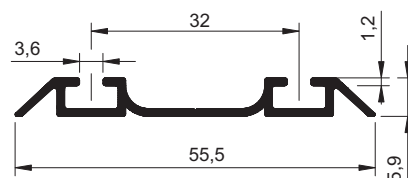
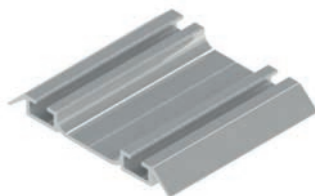

COMPATÍVEL · MONTAGEM
DES-817

DES-820

TRILHO INFERIOR DUPLO
0,295 Kg/m

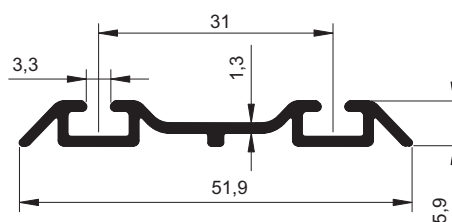
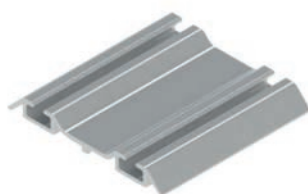

COMPATÍVEL · MONTAGEM
DES-817

DES-1284

TRILHO INFERIOR STB54
0,288 Kg/m

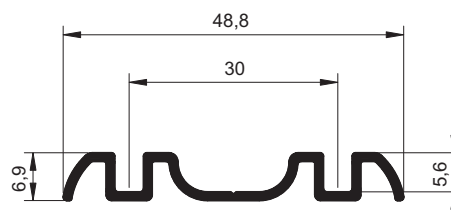
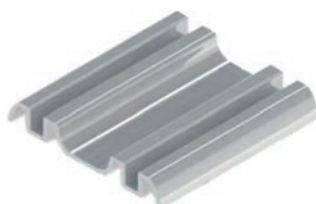

COMPATÍVEL · MONTAGEM
DES-844

A ALUMICONTE reserva-se o direito de fazer modificações em qualquer informação escrita neste catálogo sem aviso prévio. Os desenhos aqui contidos possuem medidas teóricas de massa e tolerâncias dimensionais de acordo com a ABNT NBR-816, podendo haver variações dessas informações no produto final.

DES-228

TRILHO INFERIOR DUPLO

0,213 Kg/m

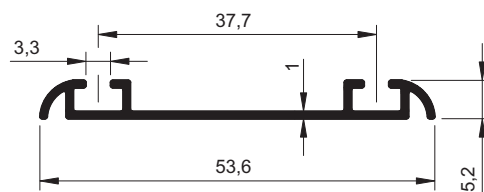

COMPATÍVEL • MONTAGEM

DES-813

DES-516

DES-269

DES-032

DES-051

TRILHO INFERIOR DUPLO

0,302 Kg/m

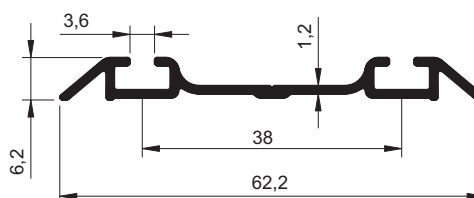
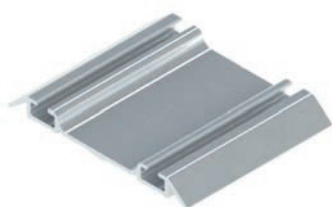

COMPATÍVEL • MONTAGEM

DES-813,

DES-516

DES-032

DES-269

DES-344

TRILHO INFERIOR DUPLO

0,294 Kg/m

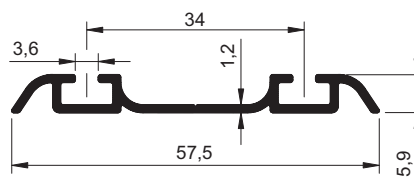
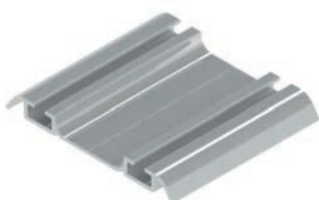

COMPATÍVEL • MONTAGEM

DES-601

DES-906

DES-603

TRILHO INFERIOR DUPLO

0,238 Kg/m

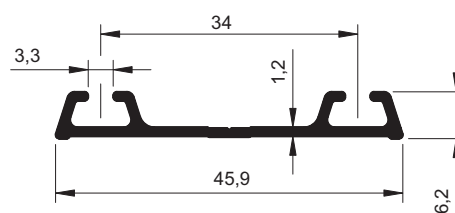
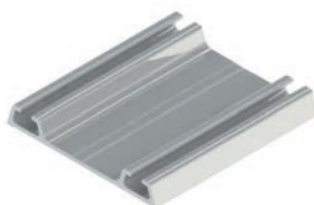

COMPATÍVEL • MONTAGEM

DES-601

DES-906

DES-843

TRILHO INFERIOR DUPLO
0,257 Kg/m

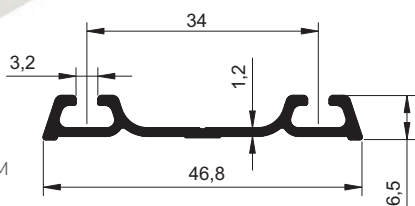
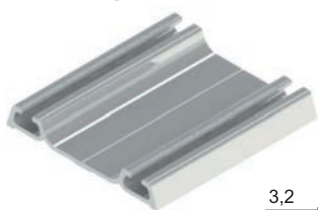

COMPATÍVEL · MONTAGEM
DES-601
DES-906

DES-824

TRILHO INFERIOR DUPLO
0,432 Kg/m

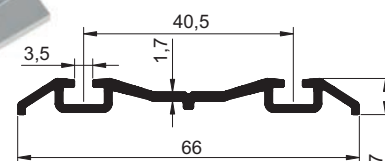
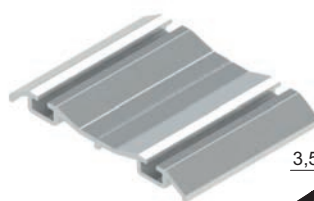

COMPATÍVEL · MONTAGEM
DES-813 | DES-516
DES-269 | DES-032

DES-907

TRILHO INFERIOR DUPLO
0,275 Kg/m

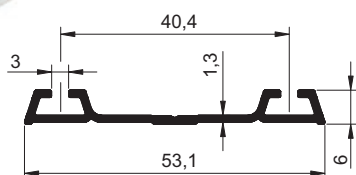
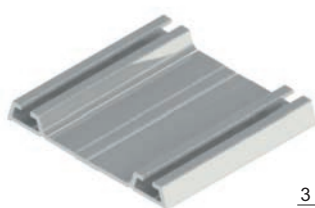

COMPATÍVEL · MONTAGEM
DES-813 | DES-516
DES-269 | DES-032

DES-049

TRILHO INFERIOR DUPLO
0,333 Kg/m

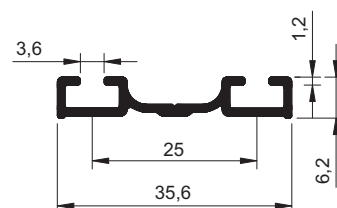

COMPATÍVEL · MONTAGEM
DES-524 | DES-511
DES-390 | DES-287 | DES-038

DES-058

TRILHO INFERIOR DUPLO
0,249 Kg/m

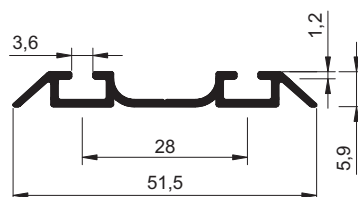
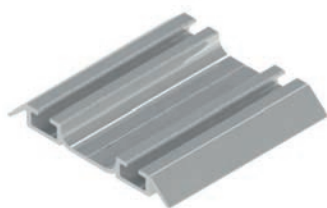

COMPATÍVEL · MONTAGEM
DES-524
DES-511
DES-390
DES-287
DES-038

DES-836

TRILHO LINEAR - SISTEMA DESLIZANTE VIDRO
0,375 Kg/m

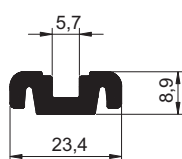

DES-1275

TRILHO INFERIOR DUPLO - SISTEMA SUSPENSO
0,697 Kg/m

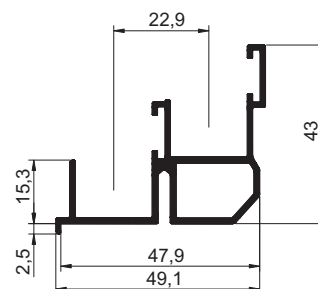

COMPATÍVEL · MONTAGEM
DES-1274

PERFIS TESTEIRA,
MONTANTE PUXADOR,
DIVISÓRIA,
PORTA E VITRINE



DES-143

TESTEIRA PERIMETRAL 18mm
0,157 Kg/m

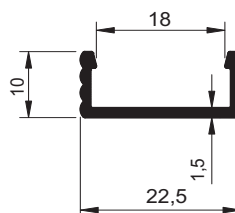
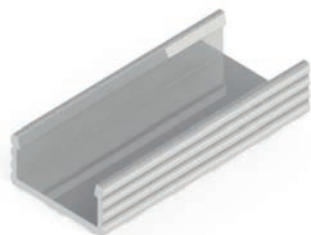

DES-248

TESTEIRA PERIMETRAL 18mm
0,207 Kg/m

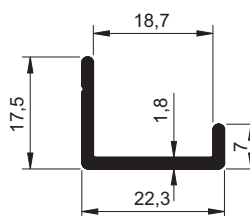

DES-693

TESTEIRA PERIMETRAL 18mm
0,272 Kg/m

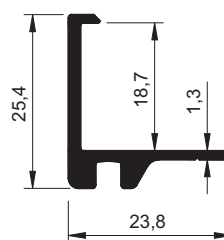

DES-292

TESTEIRA PERIMETRAL 18mm
0,256 Kg/m

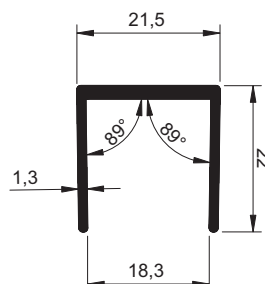

A ALUMICONTE reserva-se o direito de fazer modificações em qualquer informação escrita neste catálogo sem aviso prévio. Os desenhos aqui contidos possuem medidas teóricas de massa e tolerâncias dimensionais de acordo com a ABNT NBR-8116, podendo haver variações dessas informações no produto final.

DES-694

TESTEIRA PERIMETRAL 18mm

0,165 Kg/m

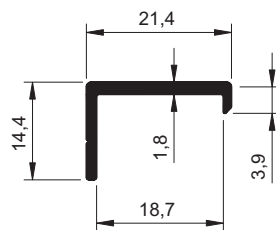
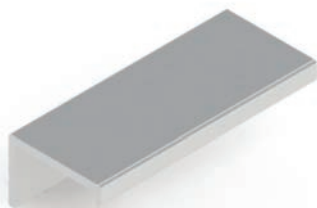

DES-249

TESTEIRA PERIMETRAL 15mm

0,193 Kg/m

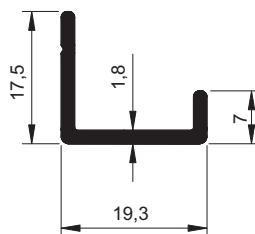

DES-1620

TESTEIRA PERIMETRAL 15mm

0,146 Kg/m

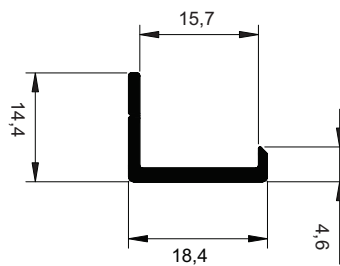

DES-165

TRILHO / TESTEIRA 15mm

0,277 Kg/m

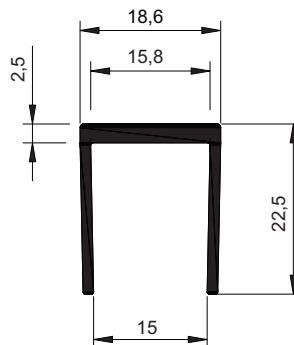
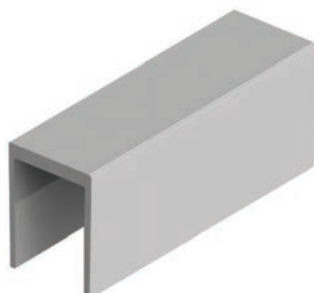

DES-205

TRILHO / TESTEIRA PERIMETRAL 15mm
0,371 Kg/m

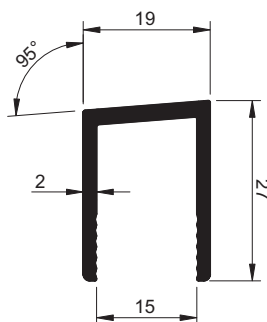

DES-150

TESTEIRA PERIMETRAL C/ ESPIGA
0,163 Kg/m

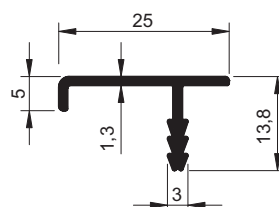
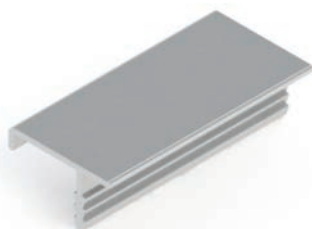

DES-884

TESTEIRA PERIMETRAL C/ ESPIGA
0,193 Kg/m

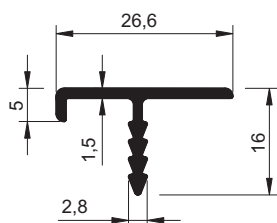
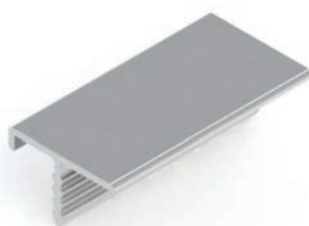

DES-241

TESTEIRA PERIMETRAL C/ ESPIGA P/ MDF 18mm
0,172 Kg/m

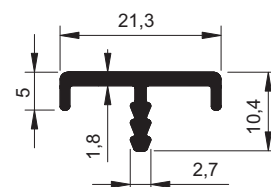

DES-240

TESTEIRA PERIMETRAL C/ ESPIGA P/ MDF 15mm
0,157 Kg/m

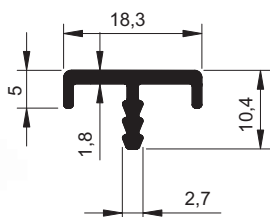

DES-293

TESTEIRA PERIMETRAL 15mm C/ PUXADOR CÔNCAVO
0,257 Kg/m

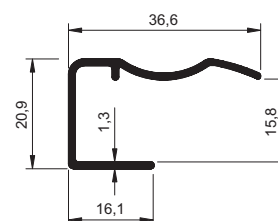

DES-104

MONTANTE PUXADOR PORTA CORRER 15mm

0,524 Kg/m

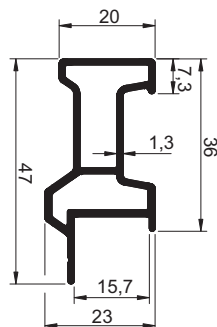
**DES-290**

MONTANTE PUXADOR PORTA CORRER 15mm

0,421 Kg/m

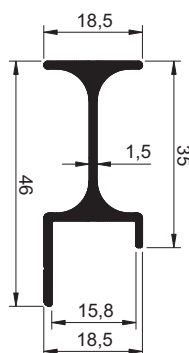
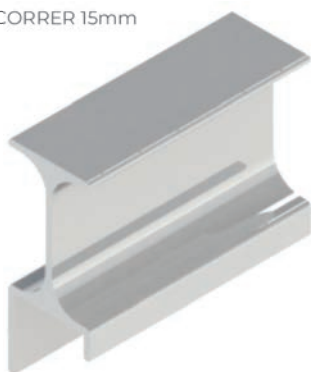
**DES-307**

MONTANTE PUXADOR PORTA CORRER 15mm

0,396 Kg/m

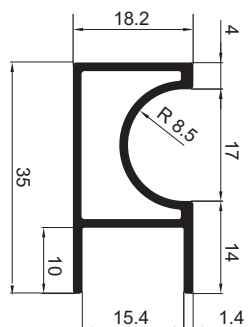
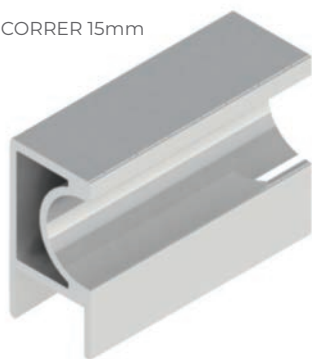
**DES-127**

MONTANTE PUXADOR PORTA CORRER 18mm

0,214 Kg/m

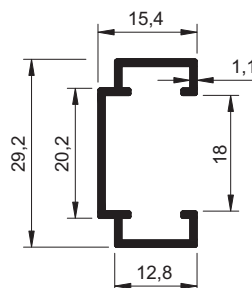

DES-291

MONTANTE PUXADOR PORTA CORRER 18mm
0,445 Kg/m

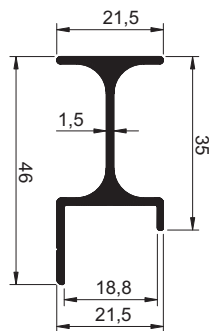

DES-121

MONTANTE PUXADOR PORTA CORRER 15mm
0,450 Kg/m

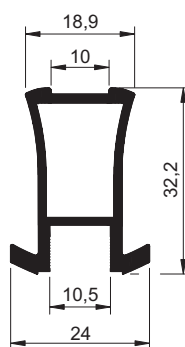

DES-334

MONTANTE PUXADOR PORTA CORRER
0,613 Kg/m

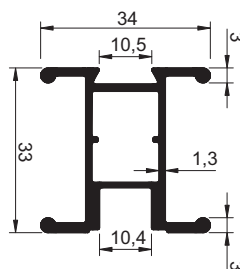

COMPATÍVEL · MONTAGEM

DES-257
DES-260



DES-259

MONTANTE PUXADOR PORTA CORRER
0,680 Kg/m

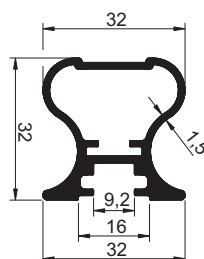

COMPATÍVEL · MONTAGEM

DES-257
DES-258
DES-260
DES-257



A ALUMICONTE reserva-se o direito de fazer modificações em qualquer informação escrita neste catálogo sem aviso prévio. Os desenhos aqui contidos possuem medidas teóricas de massa e tolerâncias dimensionais de acordo com a ABNT NBR-8116, podendo haver variações dessas informações no produto final.

DES-675

MONTANTE VIDRO PORTA CORRER
0,490 Kg/m

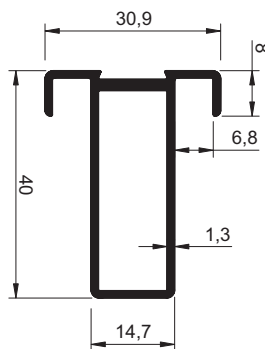

DES-810

MONTANTE PUXADOR PORTA CORRER
0,425 Kg/m

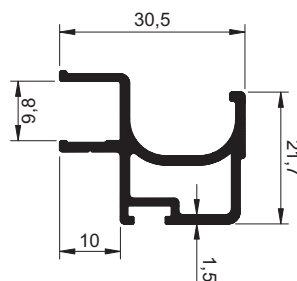
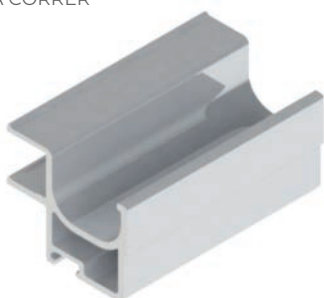

COMPATÍVEL • MONTAGEM
DES-812

DES-819

MONTANTE PUXADOR PORTA CORRER
0,406 Kg/m

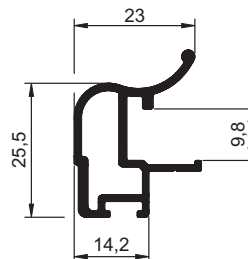
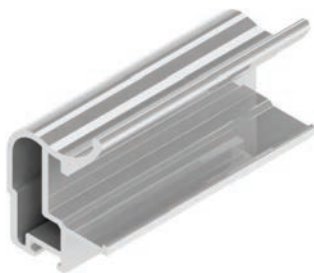

DES-822

MONTANTE PUXADOR PORTA CORRER
0,562 Kg/m

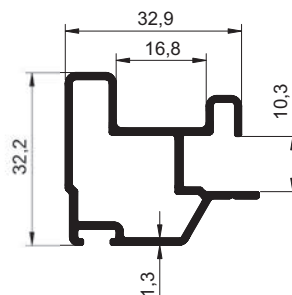
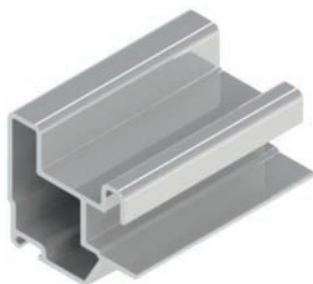

DES-846

MONTANTE PUXADOR PORTA CORRER

0,717 Kg/m

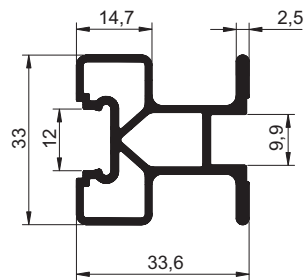
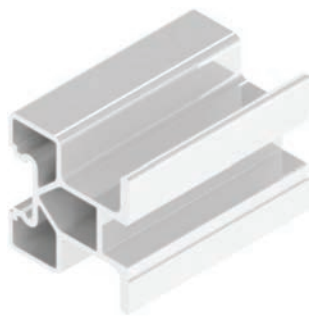

BAGUETE
BAG-004



Vidro 4mm

DES-257

TRAVESSA INFERIOR PARA PORTA DESLIZANTE

0,594 Kg/m

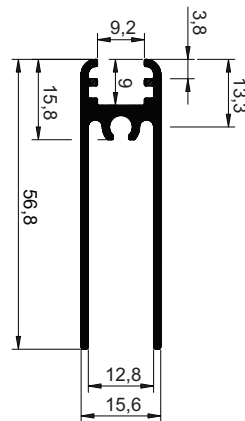
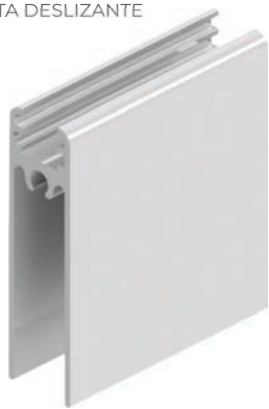

BAGUETE
BAG-015

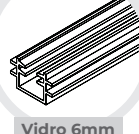

Vidro 6mm

BAGUETE
BAG-003



Vidro 4mm

DES-258

TRAVESSA INTERMEDIÁRIA PORTA CORRER

0,491 Kg/m

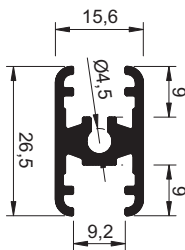

BAGUETE
BAG-015



Vidro 6mm

BAGUETE
BAG-003



Vidro 4mm

COMPATÍVEL · MONTAGEM
DES-257 | DES-259 | DES-260

DES-260

TRAVESSA SUPERIOR 8mm

0,749 Kg/m

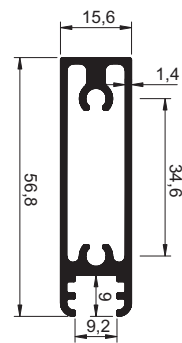

BAGUETE
BAG-015

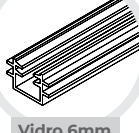

Vidro 6mm

BAGUETE
BAG-003



Vidro 4mm

DES-812

TRAVESSA SUPERIOR/INFERIOR PORTA CORRER

0,409 Kg/m

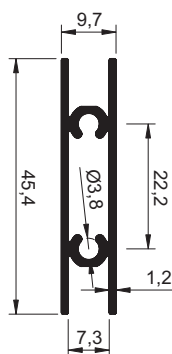

BAGUETE
BAG-006



Vidro 4mm

COMPATÍVEL · MONTAGEM
DES-810

DES-874

TRAVESSA SUPERIOR/INFERIOR PORTA CORRER

0,279 Kg/m

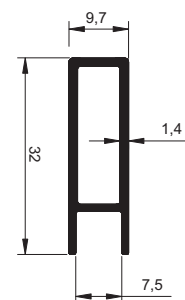

BAGUETE
BAG-006



Vidro 4mm

A ALUMICONTE reserva-se o direito de fazer modificações em qualquer informação escrita neste catálogo sem aviso prévio. Os desenhos aqui contidos possuem medidas teóricas de massa e tolerâncias dimensionais de acordo com a ABNT NBR-8116, podendo haver variações dessas informações no produto final.

DES-302

MONTANTE DIVISÓRIA AMBIENTE
0,896 Kg/m

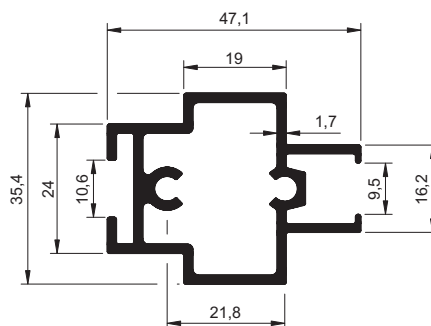
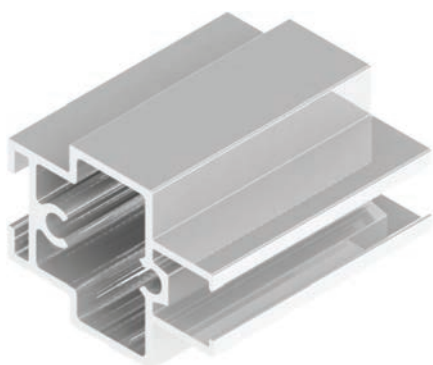

COMPATÍVEL • MONTAGEM

DES-303

DES-304

DES-303

MONTANTE DIVISÓRIA AMBIENTE
0,682 Kg/m

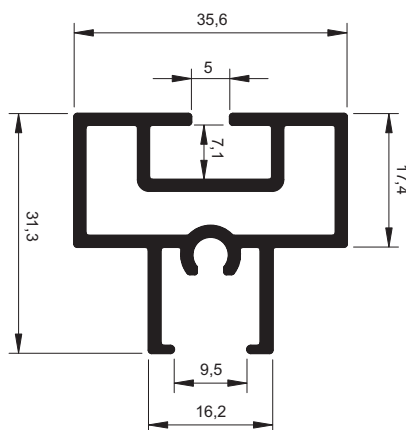
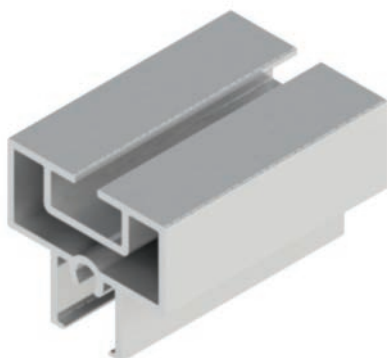

COMPATÍVEL • MONTAGEM

DES-303

DES-304

DES-304

MONTANTE DIVISÓRIA AMBIENTE
0,740 Kg/m

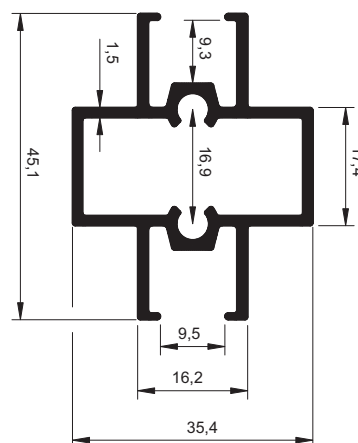

COMPATÍVEL • MONTAGEM

DES-303 | DES-302

DES-596

DIVISÓRIA AMBIENTE 15mm
0,283 Kg/m

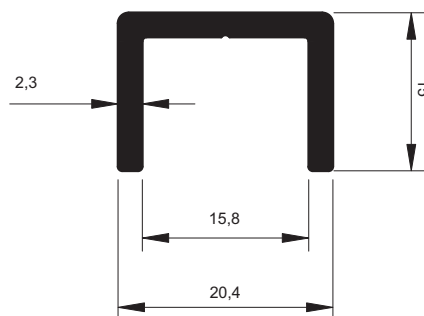
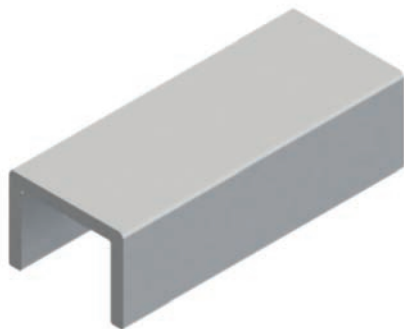

DES-599

TRAVESSA INFERIOR. DIVISÓRIA AMBIENTE
0,758 Kg/m

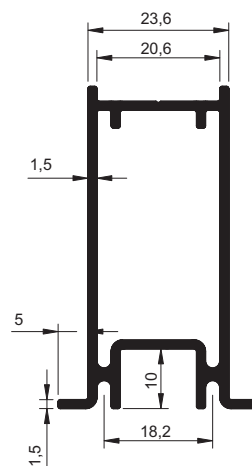

COMPATÍVEL · MONTAGEM

DES-597
DES-598
DES-600

DES-600

TRAVESSA SUPERIOR DIVISÓRIA AMBIENTE
0,810 Kg/m

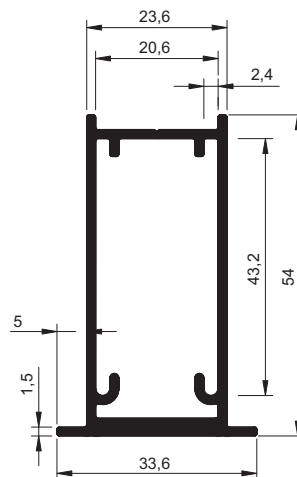

COMPATÍVEL · MONTAGEM

DES-597
DES-598
DES-599

DES-799

TRAVESSA INTERM. DIVISÓRIA AMBIENTE
0,829 Kg/m

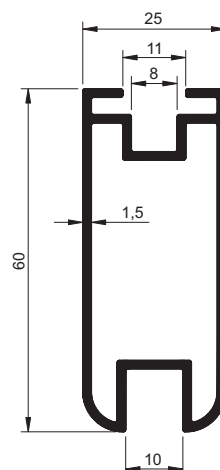
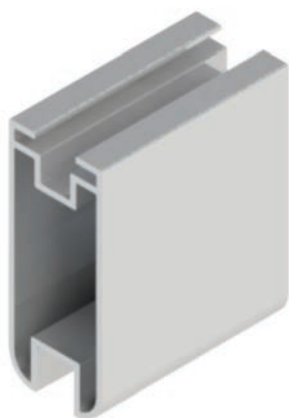

DES-597

TRAVESSA INTERM. DUPLA DIVISÓRIA AMBIENTE
0,533 Kg/m

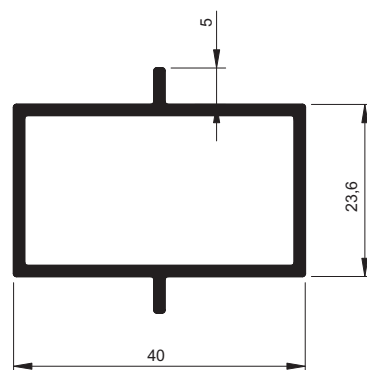
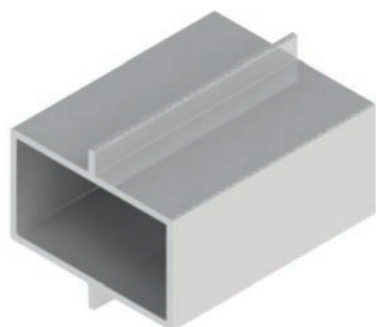

COMPATÍVEL • MONTAGEM

DES-600

DES-599

DES-598

DES-598

TRAVESSA INTERM. DIVISÓRIA AMBIENTE
0,513 Kg/m

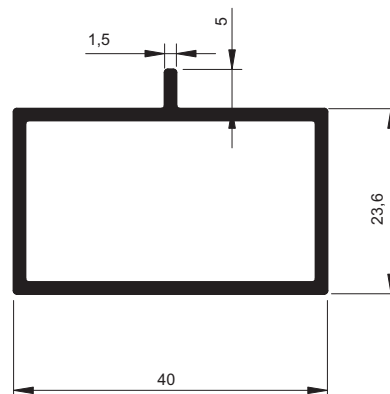
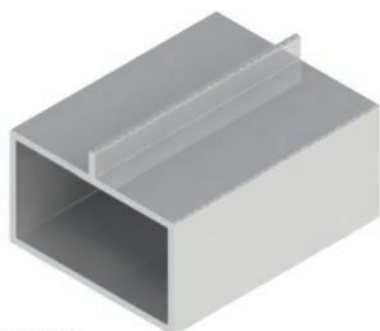

COMPATÍVEL • MONTAGEM

DES-597

DES-599

DES-600

DES-075

ESTRUTURAL VITRINE 30X50

1,123 Kg/m

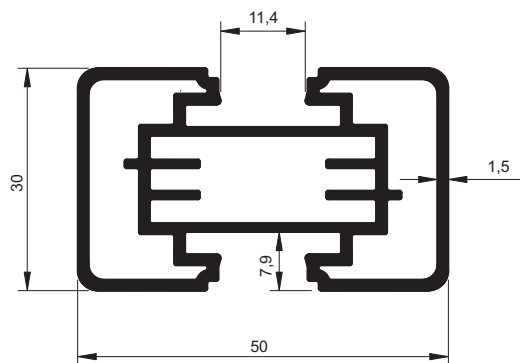
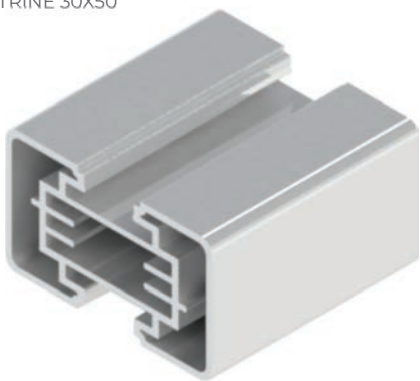
**DES-335**

ESTRUTURAL "C"

2,518 Kg/m

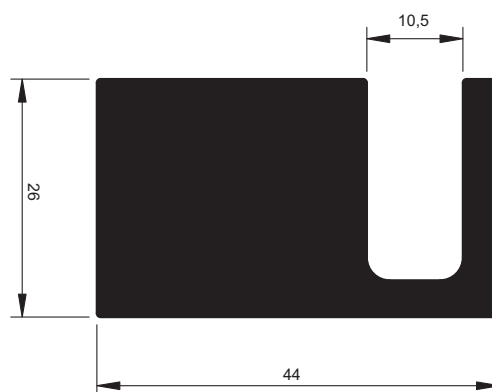
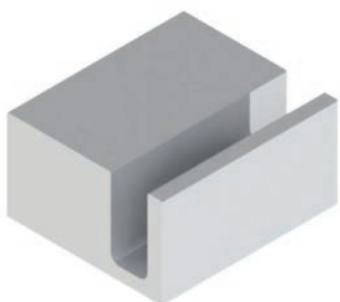
**DES-336**

ESTRUTURAL "U"

1,774 Kg/m

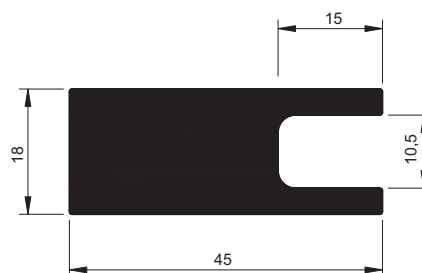
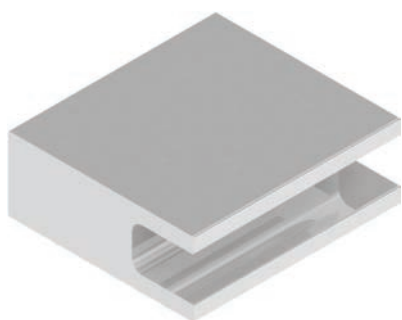

DES-400

ESTRUTURAL INDUSTRIAL 100X30

1,858 Kg/m

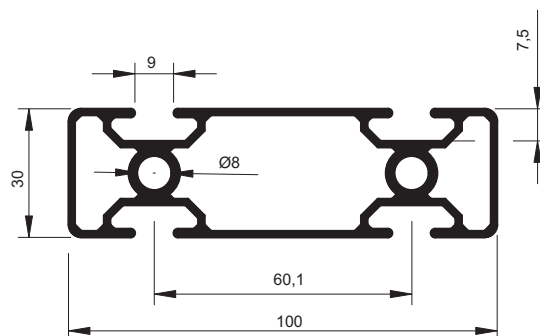
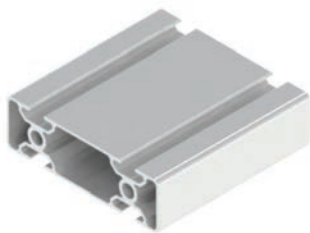
**DES-894**

ESTRUTURAL MÓVEL

1,662 Kg/m

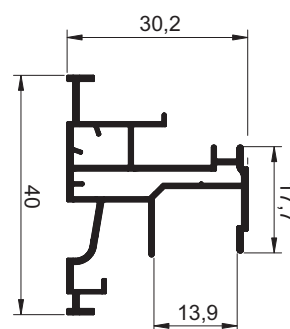
**DES-932**

ESTRUTURAL VITRINE 41x40

1,081 Kg/m

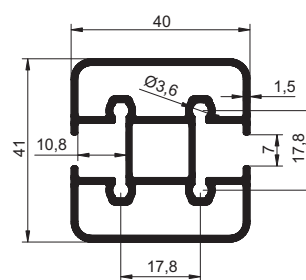
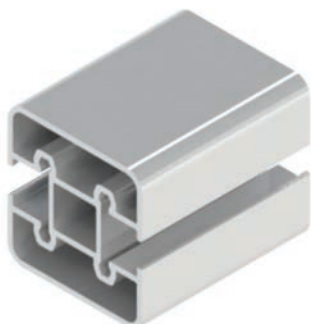
**DES-987**

ESTRUTURAL 104x31

1,234 Kg/m

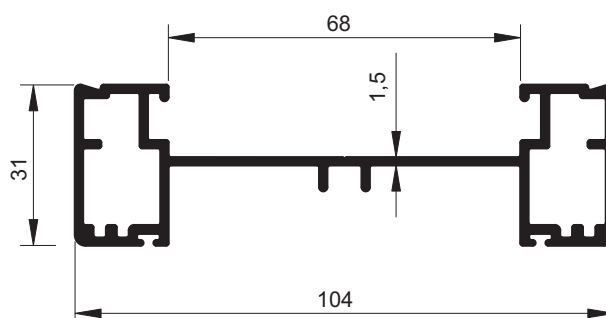
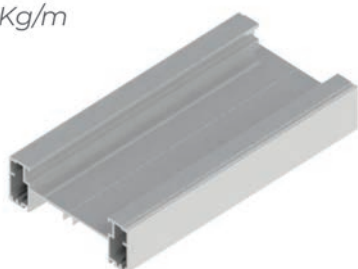

COMPATÍVEL • MONTAGEM

DES-988

DES-988

TAMPA CÔNCAVA DES-987

0,517 Kg/m

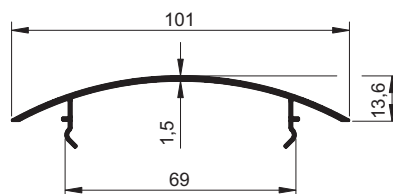

COMPATÍVEL · MONTAGEM

DES-987**DES-1289**

ESTRUTURAL TRAVESSA QUADRO

1,445 Kg/m

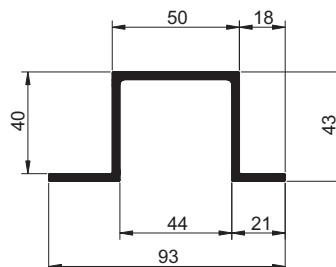
**DES-1445**

MONTANTE ESTRUTURAL

0,758 Kg/m

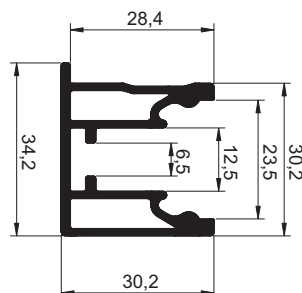

COMPATÍVEL · MONTAGEM

DES-1413**DES-1412**

MONTANTE ESTRUTURAL

0,724 Kg/m

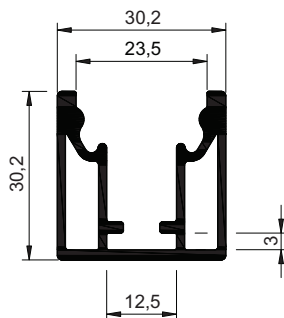

COMPATÍVEL · MONTAGEM

DES-1413**DES-1413**

CAPA MONTANTE ESTRUTURAL

0,209 Kg/m

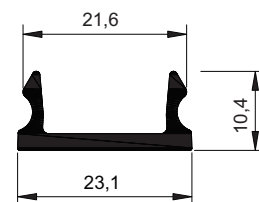
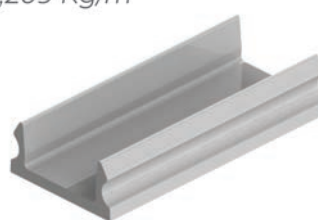

COMPATÍVEL · MONTAGEM

DES-1412**DES-1445**

DES-671

LINEAR VIDRO 10 VITRINE EXPOSITOR

0,565 Kg/m

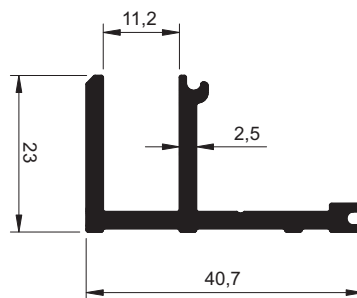
**DES-672**

LINEAR VIDRO 8 VITRINE/EXPOSITOR

0,552 Kg/m

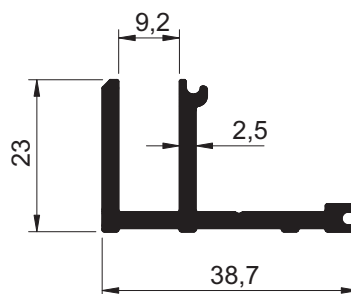

COMPATÍVEL · MONTAGEM

DES-674**DES-673**

LINEAR VIDRO 6 VITRINE/EXPOSITOR

0,538 Kg/m

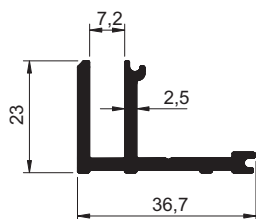

COMPATÍVEL · MONTAGEM

DES-674**DES-674**

CAPA-VITRINE/EXPOSITOR

0,157 Kg/m

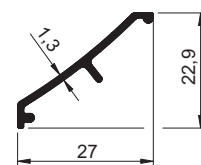

COMPATÍVEL · MONTAGEM

DES-671 | DES-672 | DES-673**DES-740**

PERFIL "X" C/ ESIPIGA VITRINE/EXPOSITOR

0,212 Kg/m

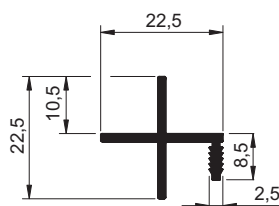
**DES-741**

PERFIL "U" C/ ESIPIGA VITRINE EXPOSITOR

0,216 Kg/m

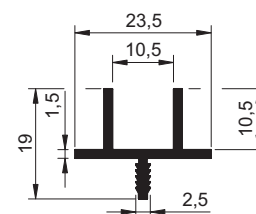



PERFIS PARA PAINEL MOVIE

Nesta seção, você encontra uma seleção de perfis desenvolvidos para a estruturação de Painel Movie.

O Painel Movie é destinado para ocultar a TV ou outros aparelhos eletrônicos, proporcionando um ambiente mais clean.

DES-1298

QUADRO PAINEL TV
2,343 Kg/m

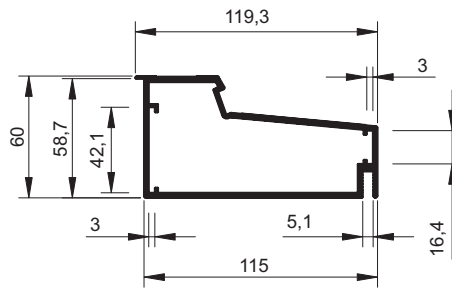
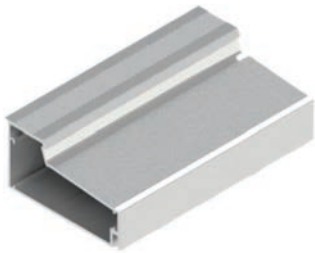

DES-1303

QUADRO PAINEL TV
0,946 Kg/m

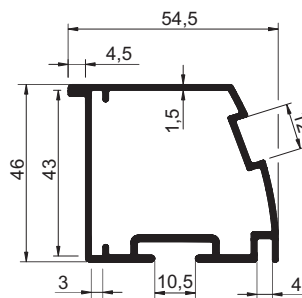

DES-851

TUBULAR SUPORTE TV | LED
1,356 Kg/m

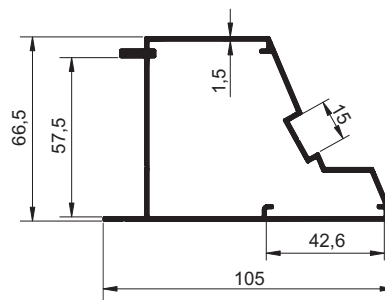

DES-852

TUBULAR SUPORTE TV | LED
0,927 Kg/m

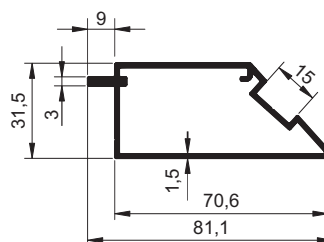

PERFIS **DIVERSOS**

Aqui você encontra uma seleção com diversos modelos de perfis que podem ser utilizados em uma variada gama de aplicações.

DES-052

TUBO CABIDEIRO REDONDO
0,242 Kg/m

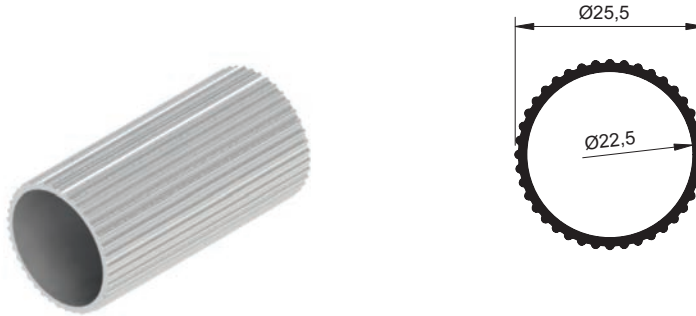

DES-157

CABIDEIRO SEÇÃO SEMI-TUBULAR
0,299 Kg/m

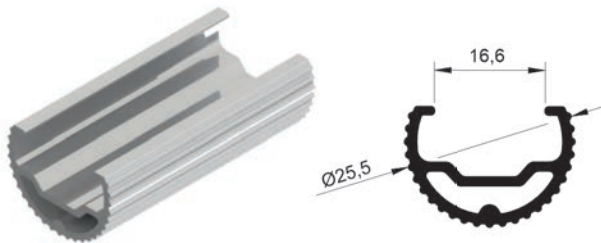

DES-387

TUBO RETANGULAR 25,4x23
0,312 Kg/m

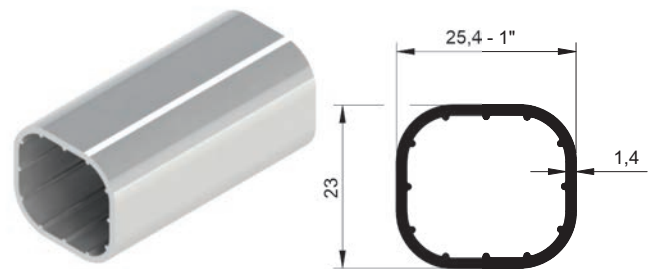

DES-161

CABIDEIRO OBLONGO
0,248 Kg/m

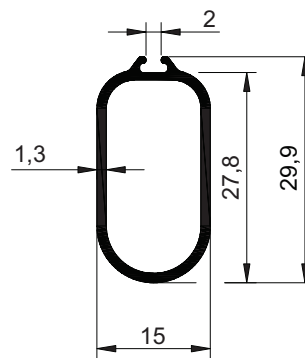

BAGUETE
BAG-001



Vidro 4mm

BAGUETE
BAG-002



Vidro 4mm

DES-1899

CABIDEIRO COM LED
0,291 Kg/m

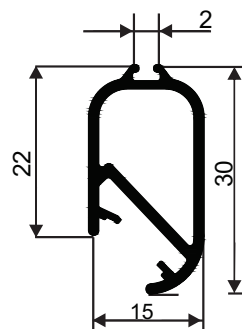

DIFUSOR
DIF-002



BAGUETE
BAG-001



Vidro 4mm

BAGUETE
BAG-002



Vidro 4mm

DES-163

CABIDEIRO OBLONGO
0,178 Kg/m

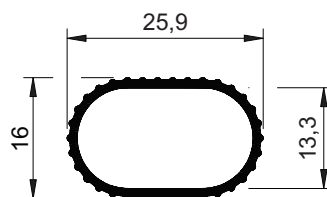
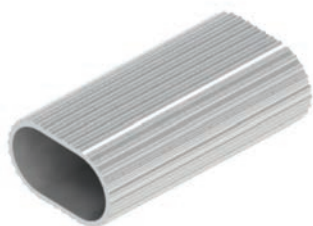

DES-271

CABIDEIRO OBLONGO
0,207 Kg/m

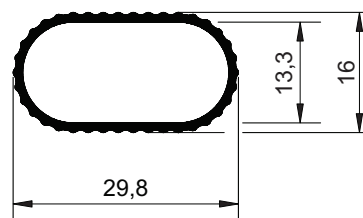
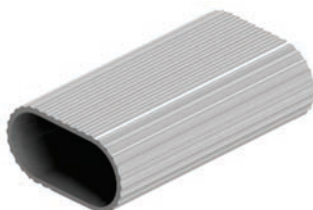

DES-1511

PUXADOR INTERNO MONTANTE
0,478 Kg/m

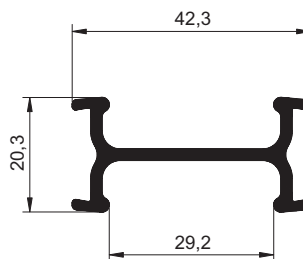
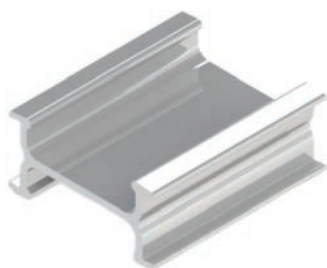

COMPATÍVEL · MONTAGEM

DES-1510

DES-1512

DES-1514

DES-100

PERPENDICULAR NÍVEL DE ALUMÍNIO
0,786 Kg/m

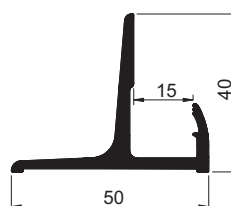

A ALUMICONTE reserva-se o direito de fazer modificações em qualquer informação escrita neste catálogo sem aviso prévio. Os desenhos aqui contidos possuem medidas teóricas de massa e tolerâncias dimensionais de acordo com a ABNT NBR-8116, podendo haver variações dessas informações no produto final.

DES-098

PERFIL PERPENDICULAR NÍVEL DE ALUMÍNIO
0,383 Kg/m



DES-181

PERFIL "I" PARALELO NÍVEL DE ALUMÍNIO
0,315 Kg/m

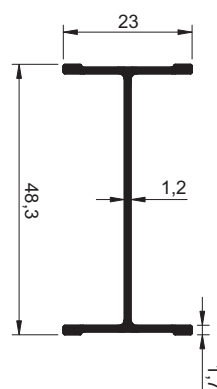

DES-099

PARALELO NÍVEL DE ALUMÍNIO
0,431 Kg/m

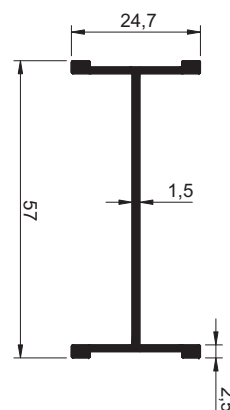

DES-1277

CANALETA ELÉTRICA
0,336 Kg/m

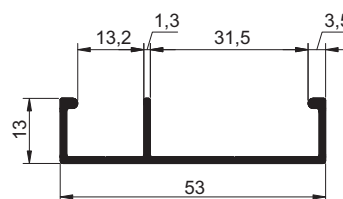
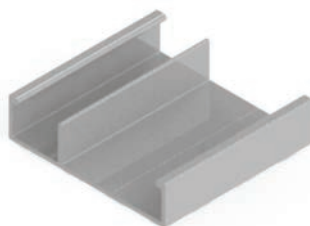

COMPATÍVEL • MONTAGEM

DES-1276

DES-1276

TAMPA CANALETA ELÉTRICA
0,192 Kg/m

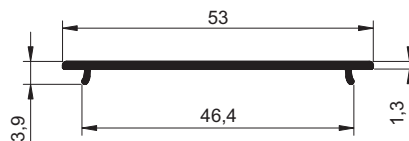
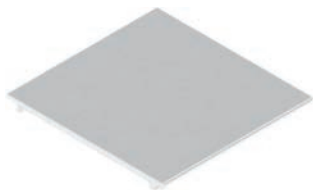

COMPATÍVEL · MONTAGEM
DES-1277

DES-079

TUBO ELIPSE 18x12
0,163 Kg/m

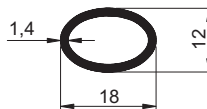

DES-1304

QUADRO DO VIDRO SISTEMA PRATELEIRA LED
0,709 Kg/m

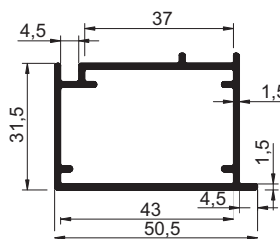
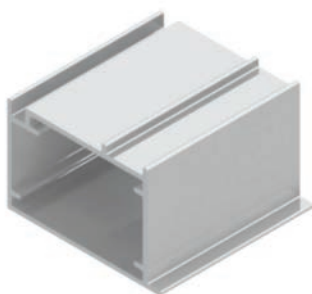

DES-1443

BORDA LUMINÁRIA LED
0,152 Kg/m

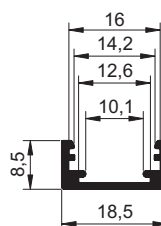
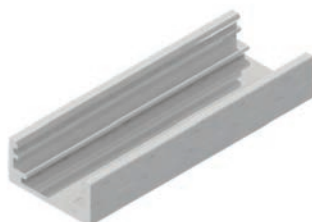

A ALUMICONTE reserva-se o direito de fazer modificações em qualquer informação escrita neste catálogo sem aviso prévio. Os desenhos aqui contidos possuem medidas teóricas de massa e tolerâncias dimensionais de acordo com a ABNT NBR-8116, podendo haver variações dessas informações no produto final.

DES-1444

BORDA LUMINÁRIA LED
0,147 Kg/m

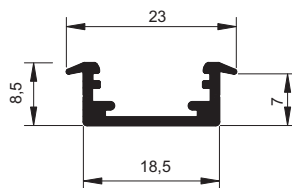
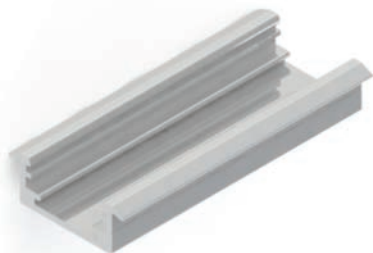

DES-1816

PERFIL BORDA LED
0,141 Kg/m

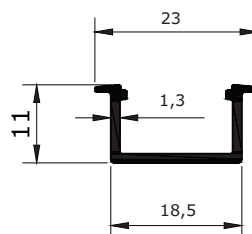
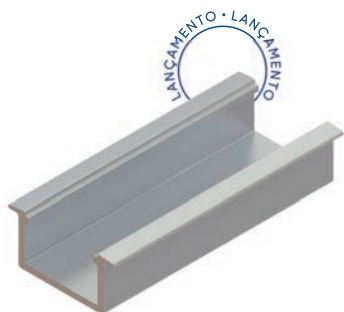

DES-097

TUBO REDONDO 2"x1,2
0,507 Kg/m

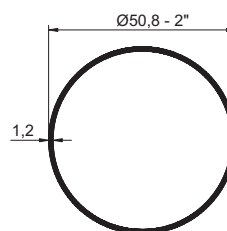

DES-342

TUBO REDONDO 1"x6,45
1,041 Kg/m

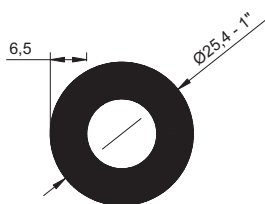

DES-289

TUBO REDONDO 1/2"x1,6
0,150 Kg/m

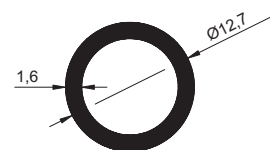

DES-1455

TUBO 3/8" x 1,2 mm
0,089 Kg/m

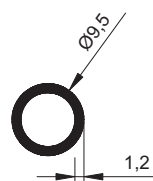

BXT-497

TUBO 19,05x1,3mm
0,199 Kg/m

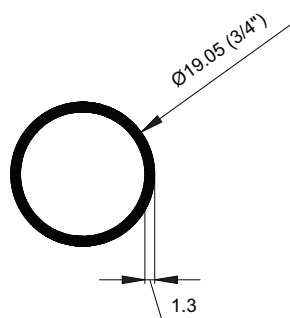

BXT-499

TUBO 1,1/2x1,3mm
0,396 Kg/m

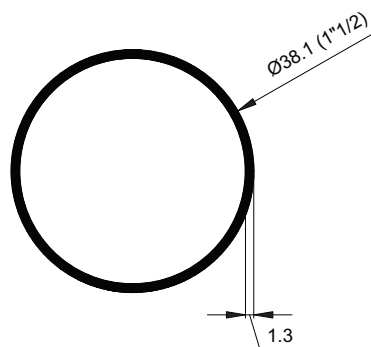

BXT-500

TUBO 1"x1,3mm
0,271 Kg/m

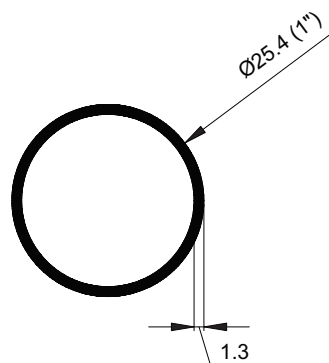

A ALUMICONTE reserva-se o direito de fazer modificações em qualquer informação escrita neste catálogo sem aviso prévio. Os desenhos aqui contidos possuem medidas teóricas de massa e tolerâncias dimensionais de acordo com a ABNT NBR-816, podendo haver variações dessas informações no produto final.

DES-1784

PERFIL LATERAL CARROCERIA
1,096 Kg/m

PONTEIRAS COMPATÍVEIS
TPA-1784
PRETO

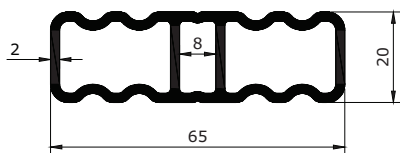
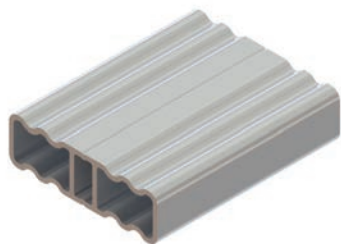

DES-1295

ESTRUTURAL MARCO REGULÁVEL
0,423 Kg/m

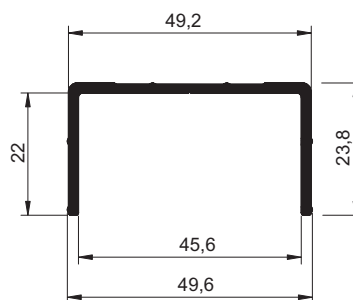
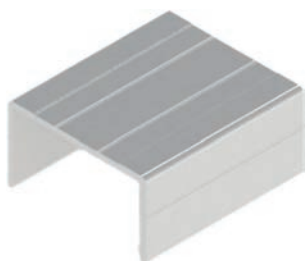

COMPATÍVEL · MONTAGEM

DES-1293
DES-1294

DES-1721

PERFIL MENOR MARCO REGULÁVEL
0,875 Kg/m

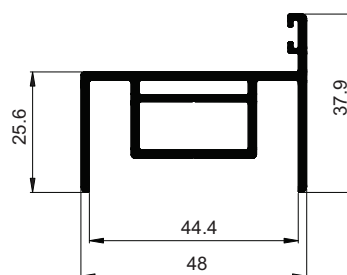
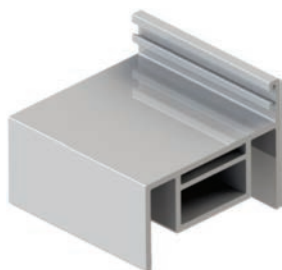

DES-1722

PERFIL MENOR ESTRUTURAL MARCO REGULÁVEL
0,418 Kg/m

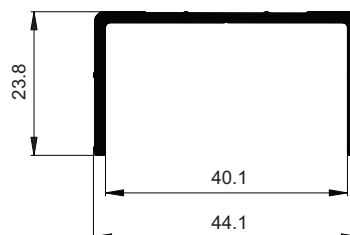
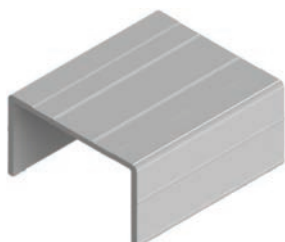

DES-1302

MARCO PERIMETRAL
0,347 Kg/m

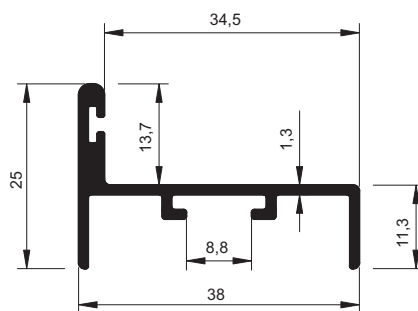
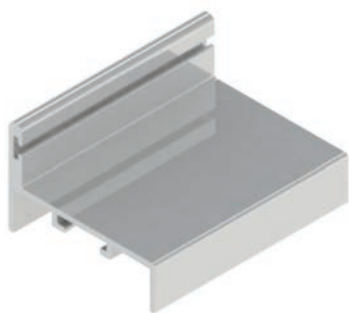

DES-1510

MONTANTE VIDRO DUPLO
0,961 Kg/m

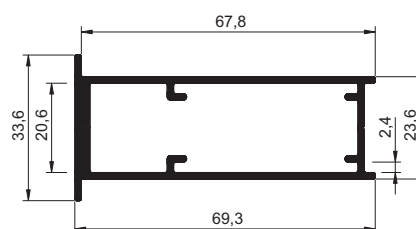
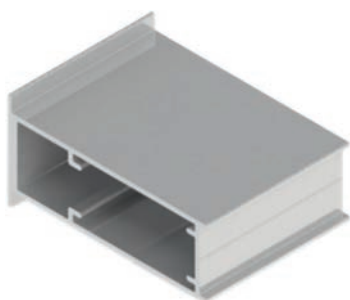

COMPATÍVEL • MONTAGEM

DES-1511

DES-1512

DES-1514

DES-1512

TRAVESSA VIDRO DUPLO
0,987 Kg/m

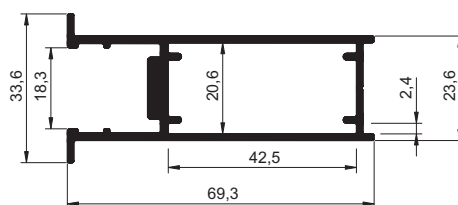
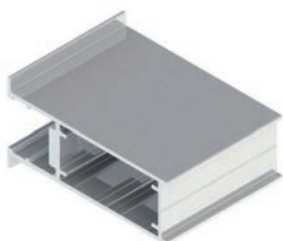

ESQUADRETA
ESQ-001



COMPATÍVEL • MONTAGEM

DES-1510

DES-1511

DES-1514

DES-1514

TRAVESSA DIVISÓRIA
0,532 Kg/m

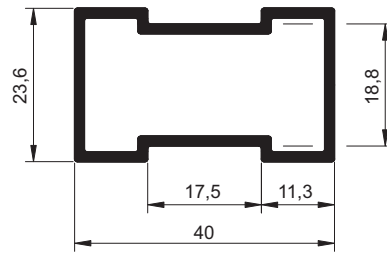

COMPATÍVEL • MONTAGEM

DES-1510

DES-1511

DES-1512

DES-086

BARRA CHATA 25x3
0,203 Kg/m

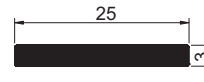
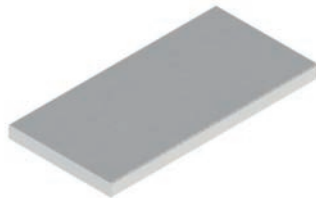

DES-087

BARRA CHATA 35x3
0,284 Kg/m

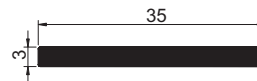
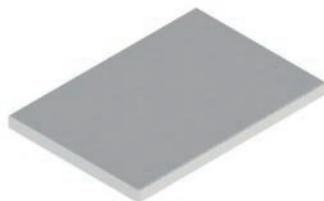

DES-140

BARRA CHATA 44,5x9,5
1,145 Kg/m

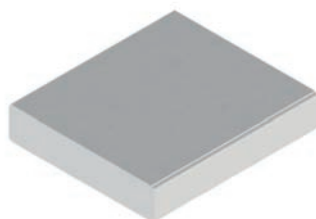

DES-267

BARRA CHATA 3/4"x1/8"-19,05x3,18
0,164 Kg/m

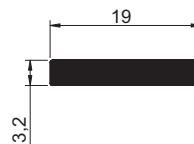
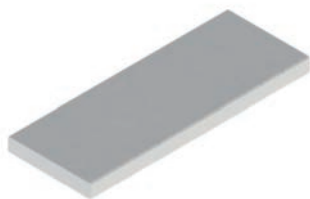

DES-319

BARRA CHATA 16x3
0,126 Kg/m

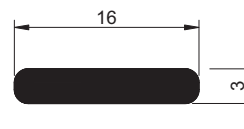

DES-742

BARRA CHATA 1/4"x43
0,740 Kg/m

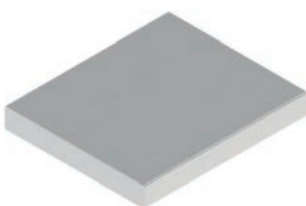

DES-873

BARRA CHATA 38,1 X 4,76 mm
0,491 Kg/m

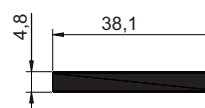
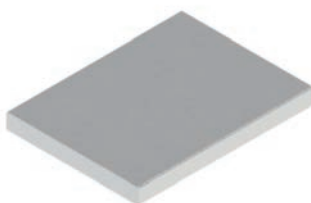

A ALUMICONTE reserva-se o direito de fazer modificações em qualquer informação escrita neste catálogo sem aviso prévio. Os desenhos aqui contidos possuem medidas teóricas de massa e tolerâncias dimensionais de acordo com a ABNT NBR-8116, podendo haver variações dessas informações no produto final.

DES-1009

BARRA CHATA 4 3/4"x5/16"-120,65x7,94
2,634 Kg/m

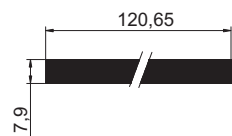
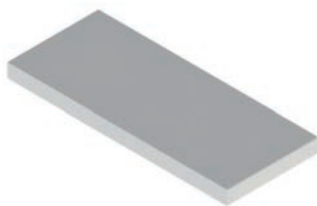

BXT-482

BARRA CHATA 3/16"x5/8"
0,207 Kg/m

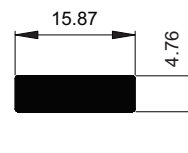

BXT-483

BARRA CHATA 4x19mm
0,207 Kg/m

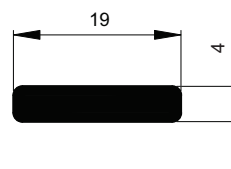
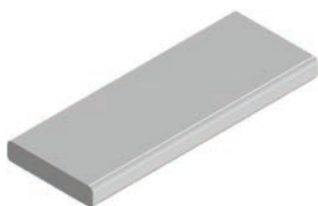

BXT-484

BARRA CHATA 4x19mm
0,284 Kg/m

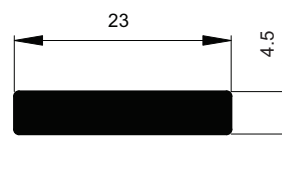
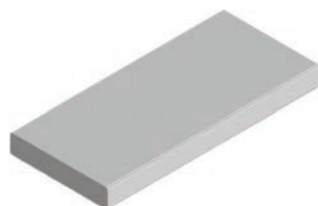

BXT-485

BARRA CHATA 2,5x19mm
0,130 Kg/m

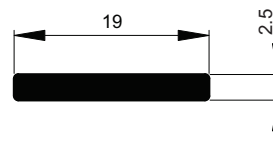

DES-255

TUBO QUADRADO 1 1/2"x2
0,783 Kg/m

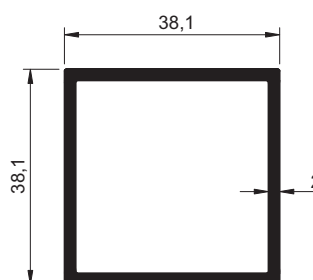

DES-256

TUBO QUADRADO 1"x1,6
0,398 Kg/m

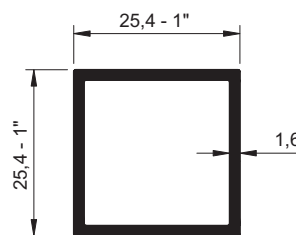

DES-386

TUBO QUADRADO 1 1/2"x1,3
0,519 Kg/m

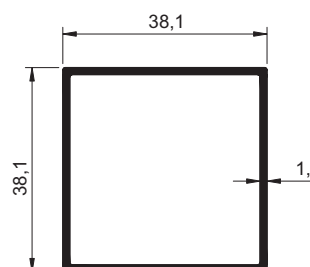

A ALUMICONTE reserva-se o direito de fazer modificações em qualquer informação escrita neste catálogo sem aviso prévio. Os desenhos aqui contidos possuem medidas teóricas de massa e tolerâncias dimensionais de acordo com a ABNT NBR-8116, podendo haver variações dessas informações no produto final.

DES-602

TUBO QUADRADO 1/2"x1,5
0,182 Kg/m

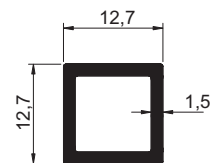

DES-998

TUBO QUADRADO 1/2" -12,7
0,148 Kg/m

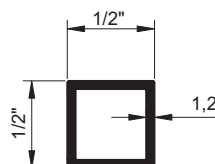

DES-1026

TUBO QUADRADO 40x1,3
0,545 Kg/m

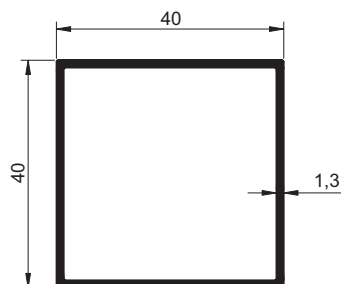

DES-1040

TUBO QUADRADO 15x2,0
0,282 Kg/m

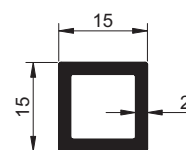

BXT-496

TUBO RETANGULAR 50x13x1,3mm
0,405 Kg/m

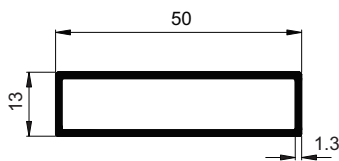
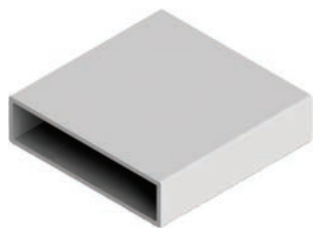

DES-677

VERGALHÃO REDONDO 7/16" - ϕ 11,1
0,263 Kg/m

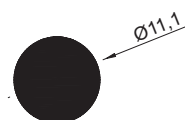

DES-678

VERGALHÃO REDONDO 1/2" ϕ 12,7
0,343 Kg/m

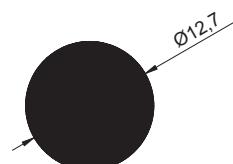

DES-1104

ESTRUTURAL
1,373 Kg/m

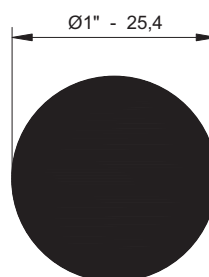

A ALUMICONTE reserva-se o direito de fazer modificações em qualquer informação escrita neste catálogo sem aviso prévio. Os desenhos aqui contidos possuem medidas teóricas de massa e tolerâncias dimensionais de acordo com a ABNT NBR-816, podendo haver variações dessas informações no produto final.

DES-151

CANTONEIRA ABA REFORÇADA 12x8

0,064 Kg/m

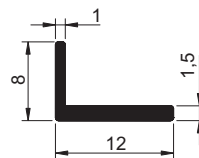

DES-243

CANTONEIRA 5/8"x1,3

0,106 Kg/m

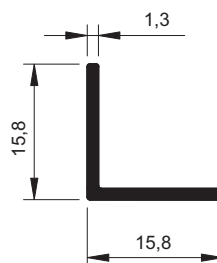

DES-244

CANTONEIRA 3/4"x1,3

0,129 Kg/m

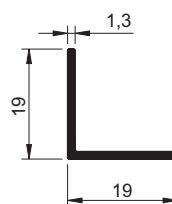

ALU-043

CANTONEIRA

0,481 Kg/m

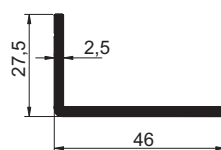
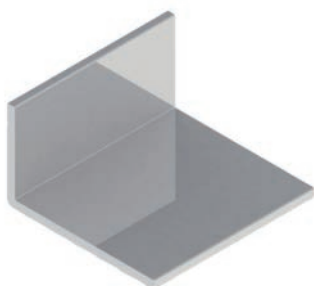

ALU-044

CANTONEIRA
0,861 Kg/m

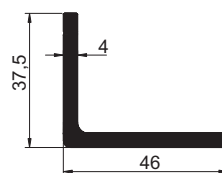

BXT-498

CANTONEIRA 50,8X2mm
0,548 Kg/m

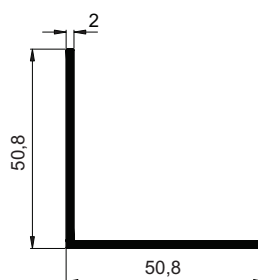

DES-1458

CANTONEIRA 19 x 19mm
0,117 Kg/m

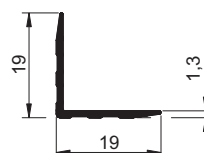

DES-027D6

SUPORE LUMINÁRIA
0,293 Kg/m

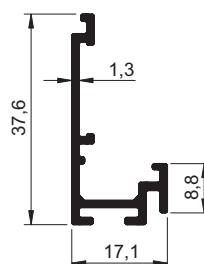

DES-083

CONECTOR MDF FUNDO MÓVEL

0,144 Kg/m

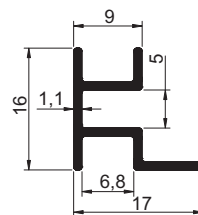

DES-093

GUIA DE ENCAIXE VIDRO 10

0,227 Kg/m

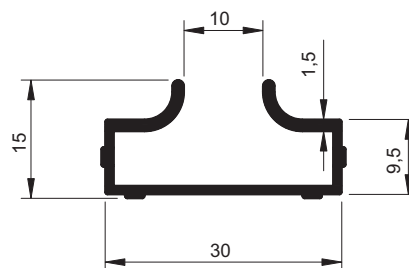

DES-171

PERFIL "U" 29x14

0,218 Kg/m

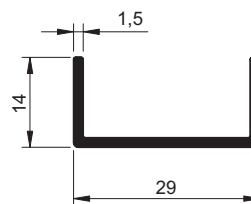
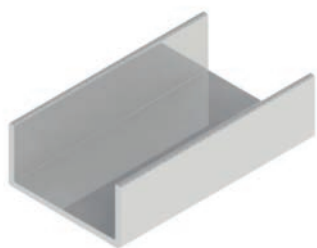

DES-229

PERFIL "J" 15x20,6

0,204 Kg/m

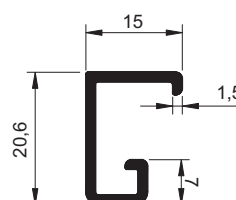

DES-246

PERFIL "H" C/ REFORÇO CENTRAL 17x8,8
0,169 Kg/m

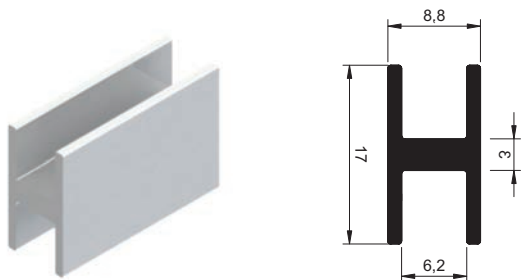

DES-2090

PERFIL DIVISOR H 18mm
0,552 Kg/m

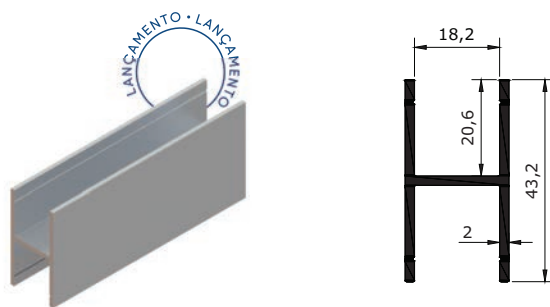

DES-615

PERFIL "U" 20x35 MDF 15
0,622 Kg/m

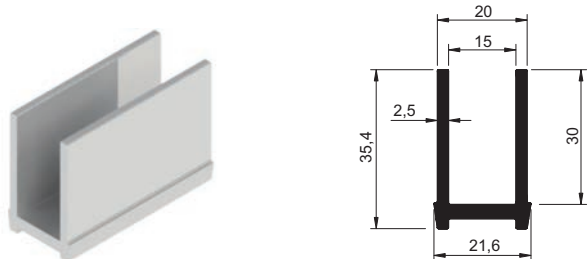

DES-2089

PERFIL DIVISOR H 15mm
0,533 Kg/m

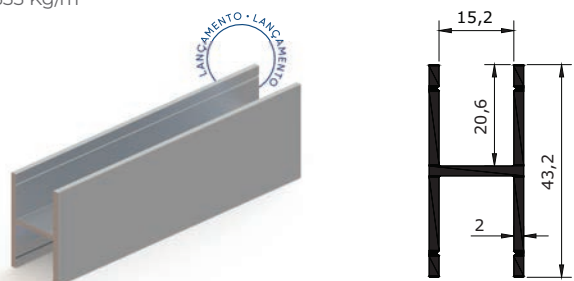

DES-616

PERFIL "U" 24x36 MDF 18
0,713 Kg/m



DES-666

PERFIL "U" 30x29,3 C/ ALOJAMENTO VEDAÇÃO
0,533 Kg/m



DES-670

CANTO VITRINE/EXPOSITOR
0,564 Kg/m

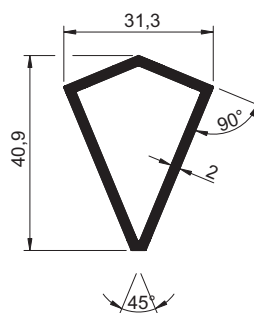
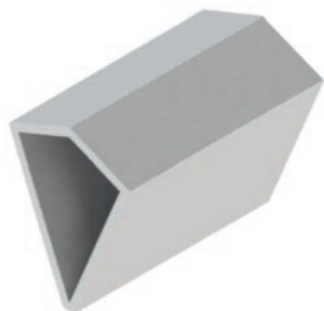

DES-841

PERFIL "C" 9,5x6
0,076 Kg/m

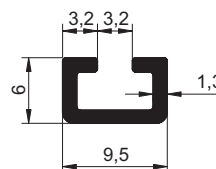

DES-888

PERFIL "U" C/ OLHAL INTERNO
0,292 Kg/m

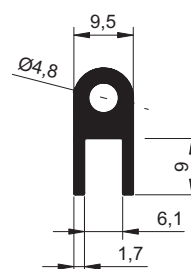

DES-1083

GUIA SISTEMA MESA DESLIZANTE
0,137 Kg/m

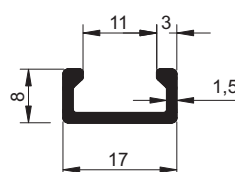

DES-1270

PUXADOR ENCAIXE MDF/VIDRO

0,357 Kg/m

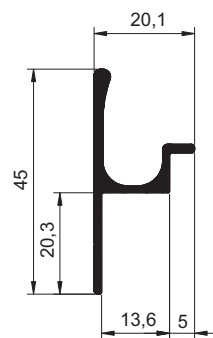

DES-1281

ESTRUTURAL BOLEADO

0,944 Kg/m

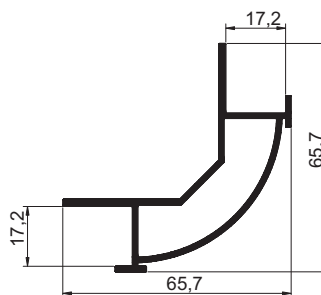

DES-1290

ONDULADO 72 x 3,6 mm

0,291 Kg/m

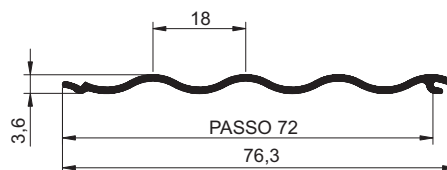

A ALUMICONTE reserva-se o direito de fazer modificações em qualquer informação escrita neste catálogo sem aviso prévio. Os desenhos aqui contidos possuem medidas teóricas de massa e tolerâncias dimensionais de acordo com a ABNT NBR-816, podendo haver variações dessas informações no produto final.

DES-1457

ENCAIXE 7mm
0,196 Kg/m

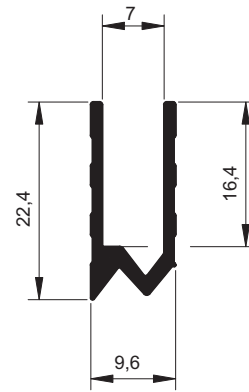
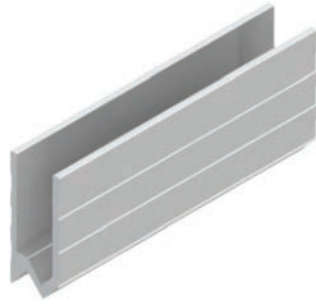

DES-1477

MONTANTE TRASEIRO VITRINE
0,952 Kg/m

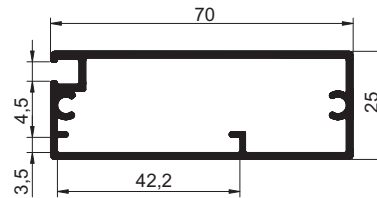
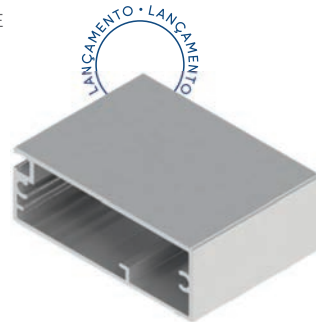

DES-1478

MONTANTE FRONTAL VITRINE | LED
0,989 Kg/m

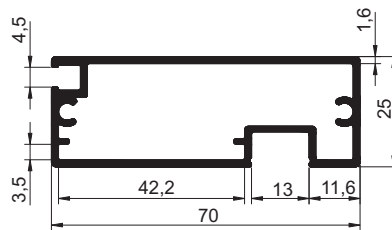
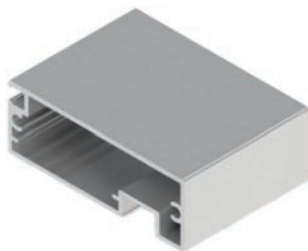

DES-1479

MONTANTE CENTRAL VITRINE
0,943 Kg/m

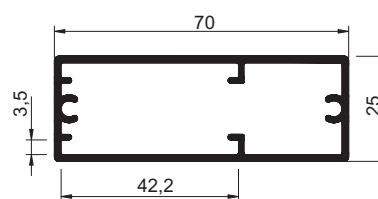
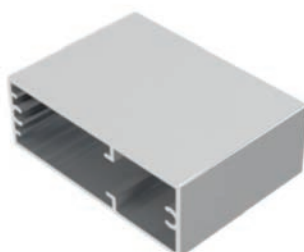

DES-1480

MONTANTE CENTRAL VITRINE LED
0,991 Kg/m

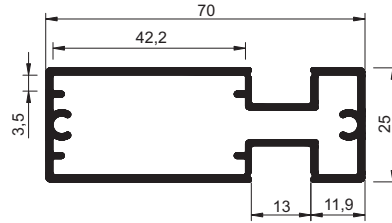
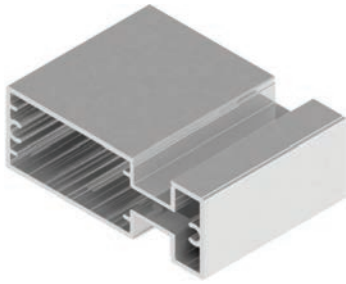

DES-1487

QUADRO PRATELEIRA LED
0,573 Kg/m

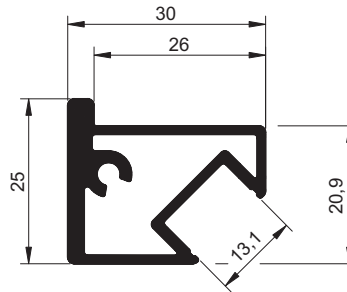

DES-1488

QUADRO PRATELEIRA LED
0,515 Kg/m

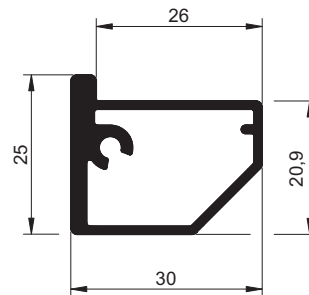

DES-1409

QUADRO PRATELEIRA LED
0,470 Kg/m

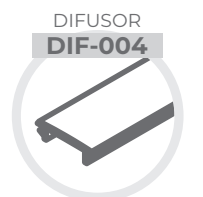
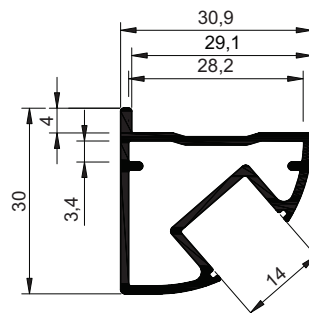

COMPATÍVEL • MONTAGEM

DES-1410
DES-1411

A ALUMICONTE reserva-se o direito de fazer modificações em qualquer informação escrita neste catálogo sem aviso prévio. Os desenhos aqui contidos possuem medidas teóricas de massa e tolerâncias dimensionais de acordo com a ABNT NBR-8116, podendo haver variações dessas informações no produto final.

DES-1410

QUADRO PRATELEIRA
0,396 Kg/m

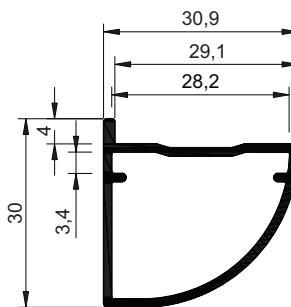

COMPATÍVEL · MONTAGEM

DES-1409
DES-1411

DES-1411

QUADRO LATERAL PRATELEIRA
0,445 Kg/m

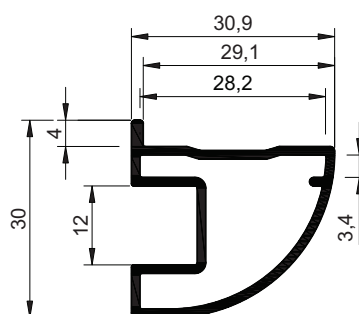

COMPATÍVEL · MONTAGEM

DES-1409
DES-1410

DES-1515

TRILHO MÃO DE AMIGO
0,080 Kg/m

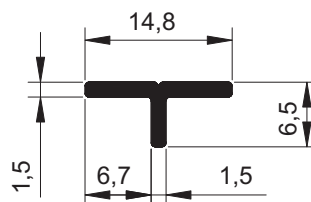

DES-1253

COMPLEMENTO CAVA DUPLA 49x22
0,559 Kg/m

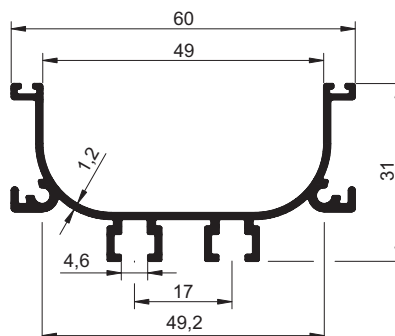

BAGUETE
BAG-001



Vidro 4mm

BAGUETE
BAG-002



Vidro 4mm

DES-1254

COMPLEMENTO CAVA SIMPLES 45x22,5

0,452 Kg/m

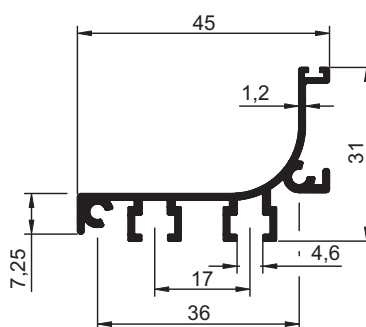

BAGUETE
BAG-001



Vidro 4mm

BAGUETE
BAG-002



Vidro 4mm

DES-1255

COMPLEMENTO CAVA SIMPLES 57x20

0,447 Kg/m

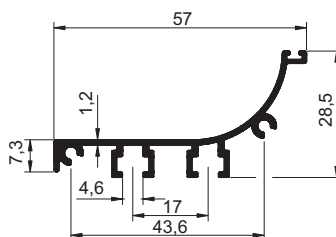
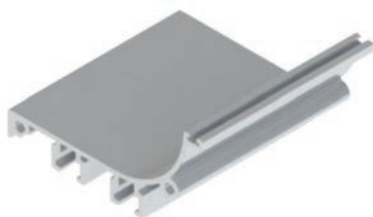

BAGUETE
BAG-001



Vidro 4mm

BAGUETE
BAG-002



Vidro 4mm

DES-880

TUBO QUADRADO 38mm C/ OLHAL FIXAÇÃO

0,928 Kg/m

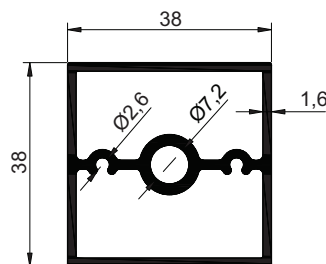
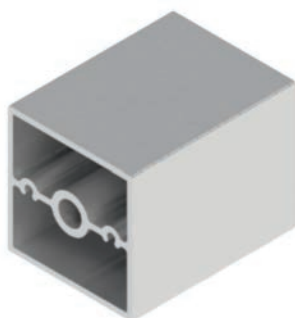

ALV-2511

LAMBRI RIPADO 35mm
1,017 Kg/m

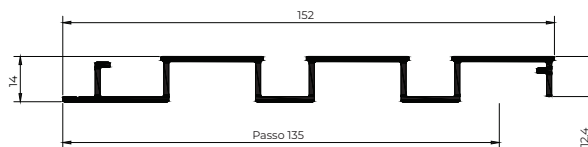
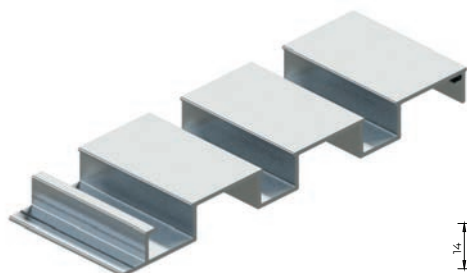

ALV-2512

LAMBRI RIPADO PASSO 120mm
1,019 Kg/m

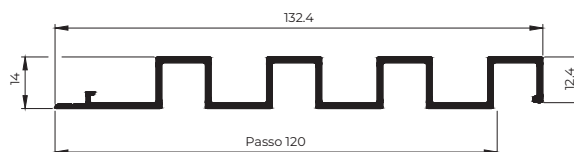
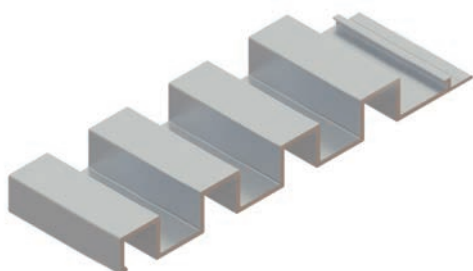

ALV-2513

PERFIL LAMBRI CONTEMPORANEO PASSO 73
0,708 Kg/m

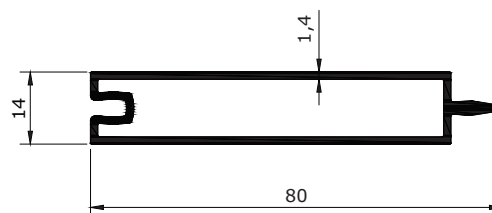
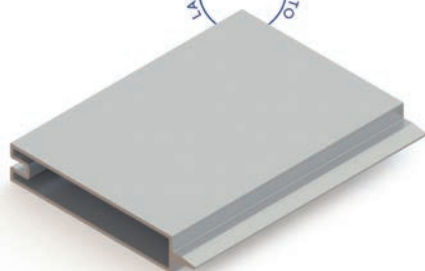

DES-1517

MONTANTE VIDRO DUPLO
0,738 Kg/m

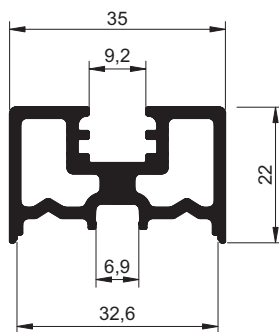
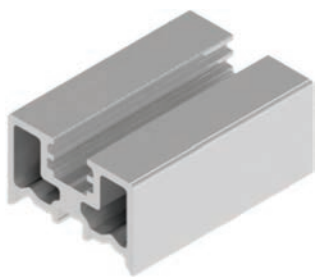

DES-1518

CAPA MONTANTE
0,140 Kg/m

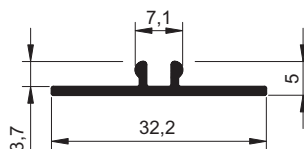
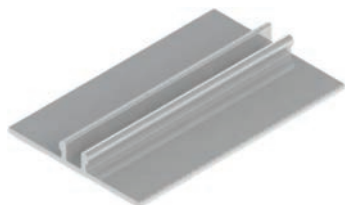

DES-1519

TRAVESSA DIVISÓRIA
0,783 Kg/m

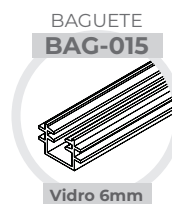
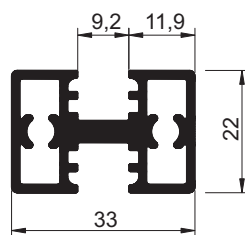
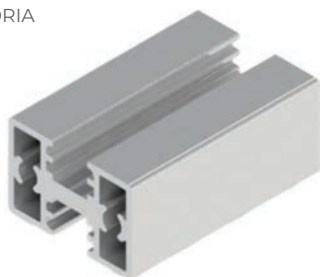

DES-1516

TRAVESSA SUP/INF VIDRO DUPLO
0,851 Kg/m

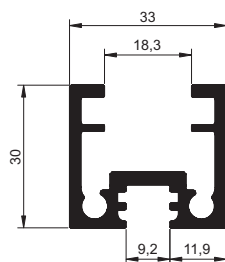

DES-1526

PERFIL TRAVESSA SUPERIOR
0,962 Kg/m

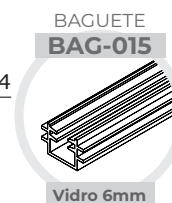
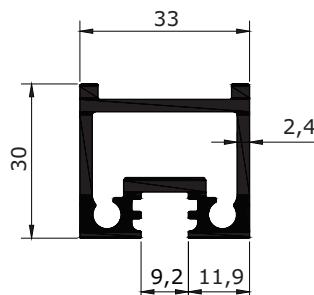
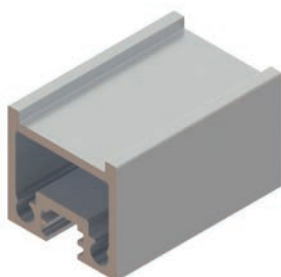

Alumiconte

ARMO

LANÇAMENTO!

A Alumiconte Armo foi desenvolvida para entregar o melhor custo-benefício para você. Praticidade, qualidade e leveza!



ARM-062

PERFIL QUADRO VIDRO
45 X 19,7 X 0,95 mm
0,335 Kg/m

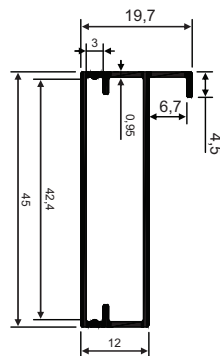
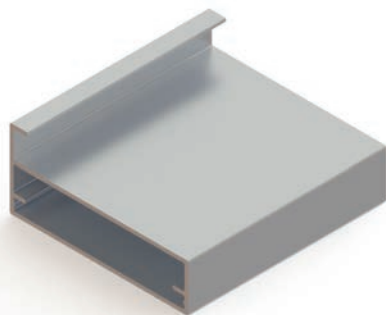

ESQUADRETA
ESQ-001



COMPATÍVEL · MONTAGEM

DES-239
DES-1252

ARM-198

PERFIL QUADRO VIDRO
5x20,05x0,95mm
0,350g/m

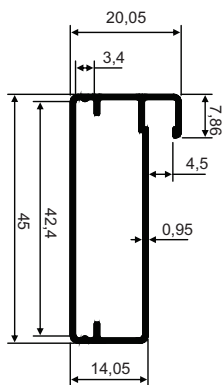
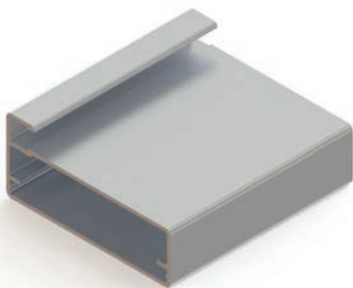

ESQUADRETA
ESQ-001



BAGUETE
BAG-008



Vidro 4mm

COMPATÍVEL · MONTAGEM

DES-239
DES-1252
ARM-204

ARM-204

PERFIL QUADRO VIDRO C/ PUXADOR
0,533 Kg/m

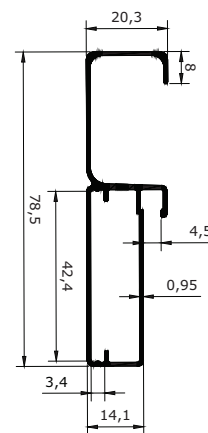

BAGUETE
BAG-007



Vidro 4mm

COMPATÍVEL · MONTAGEM

ARM-198

ARM-530

PERFIL QUADRO VIDRO
45x17,7x0,95mm
0,329 Kg/m

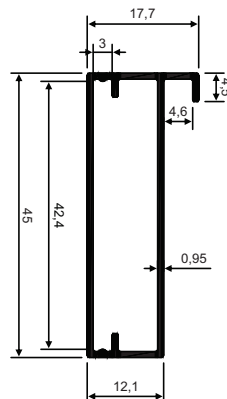

ESQUADRETA
ESQ-001



COMPATÍVEL · MONTAGEM

DES-395

TRILHOS PARA ESQUADRIAS DE **MADEIRA**

Perfis desenvolvidos especialmente para aplicação em esquadrias de madeira, contribuindo para seu desempenho e leveza de movimento.



DES-006

TRILHO ESQUADRIAS MADEIRA
0,181 Kg/m

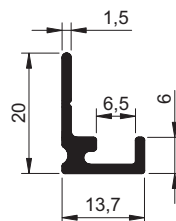

DES-027

TRILHO ESQUADRIAS MADEIRA
0,161 Kg/m

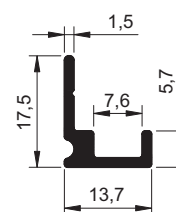

DES-028

TRILHO ESQUADRIAS MADEIRA
0,138 Kg/m

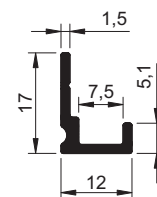

DES-059

TRILHO ESQUADRIAS MADEIRA
0,222 Kg/m

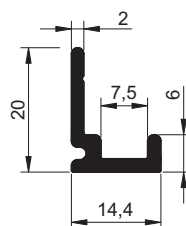

A ALUMICONTE reserva-se o direito de fazer modificações em qualquer informação escrita neste catálogo sem aviso prévio. Os desenhos aqui contidos possuem medidas teóricas de massa e tolerâncias dimensionais de acordo com a ABNT NBR-8116, podendo haver variações dessas informações no produto final.

DES-164

TRILHO ESQUADRIAS MADEIRA

0,265 Kg/m

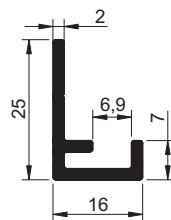
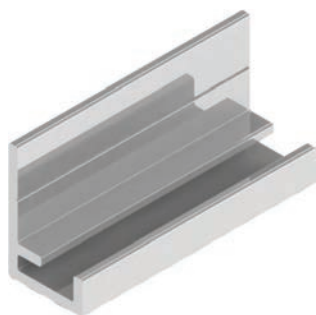

DES-242

TRILHO LINEAR - ROLDANA CÔNCAVA

0,166 Kg/m

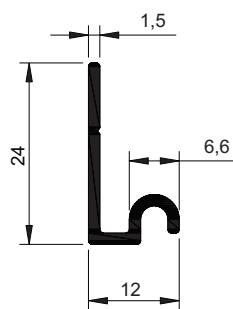

DES-033

TRILHO ESQUADRIAS MADEIRA

0,792 Kg/m

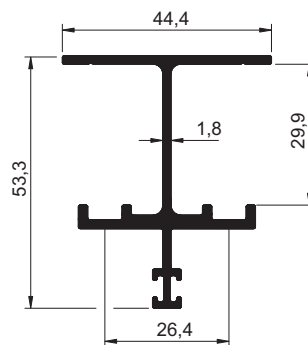
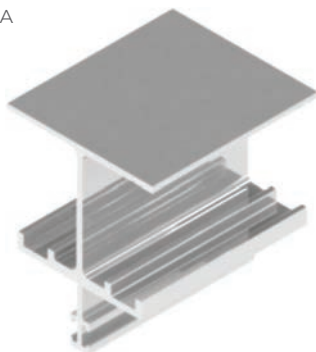

DES-034

TRILHO ESQUADRIAS MADEIRA

0,542 Kg/m

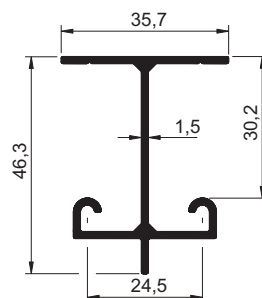
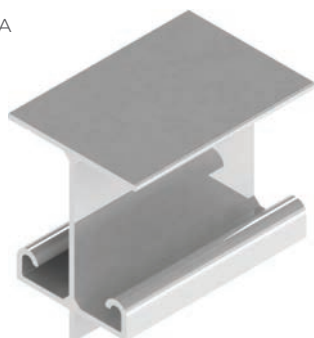

DES-040

TRILHO ESQUADRIAS MADEIRA

0,616 Kg/m

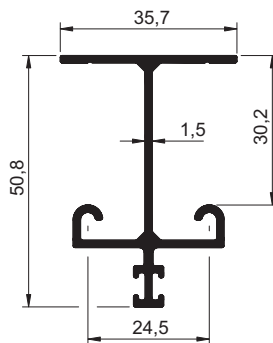

DES-166

TRILHO SUPERIOR ESQUADRIAS MADEIRA

1,434 Kg/m

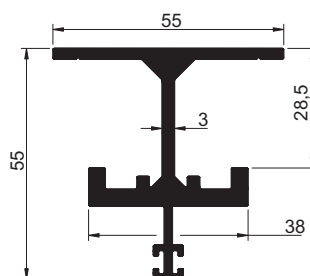
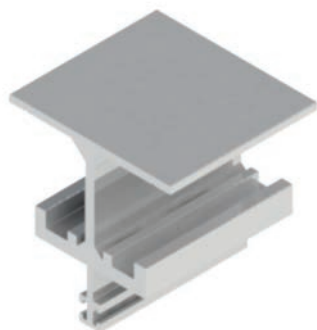

DES-876

TRILHO ESQUADRIAS MADEIRA

0,647 Kg/m

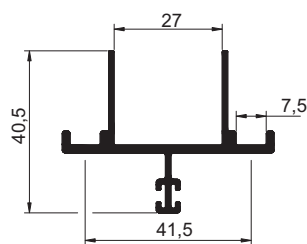

DES-029

TRILHO ESQUADRIAS MADEIRA

0,179 Kg/m

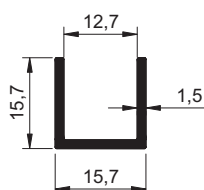

DES-031

TRILHO ESQUADRIAS MADEIRA

0,140 Kg/m

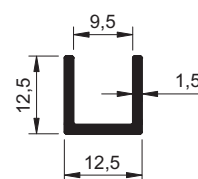

A ALUMICONTE reserva-se o direito de fazer modificações em qualquer informação escrita neste catálogo sem aviso prévio. Os desenhos aqui contidos possuem medidas teóricas de massa e tolerâncias dimensionais de acordo com a ABNT NBR-816, podendo haver variações dessas informações no produto final.

LANÇAMENTO!

ALUMICONTE **Ísis**

A Alumiconte Ísis é composta por perfis e componentes que formam estruturas robustas para portas pivotantes.

FECHAMENTO

Desenvolvida para receber fechamento em:

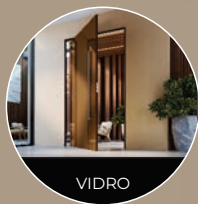

VIDRO



ACM

Recomendação:
vidro temperado
4mm.

FORMAS DE AQUISIÇÃO:

- Em Kit: composto por perfis e componentes na quantidade certa para a fabricação de 1 porta de até 2,0x3,0m.
- Perfis em barras de 6m e componentes separadamente.

ACABAMENTOS & CORES

Jateado e Anodizado

Fosco | Bronze 1001 | Bronze 1002

Pintura Eletrostática

Branco | Preto Órion



Na montagem da sua porta pivotante

ALUMICONTE ÍSIS

você vai utilizar:

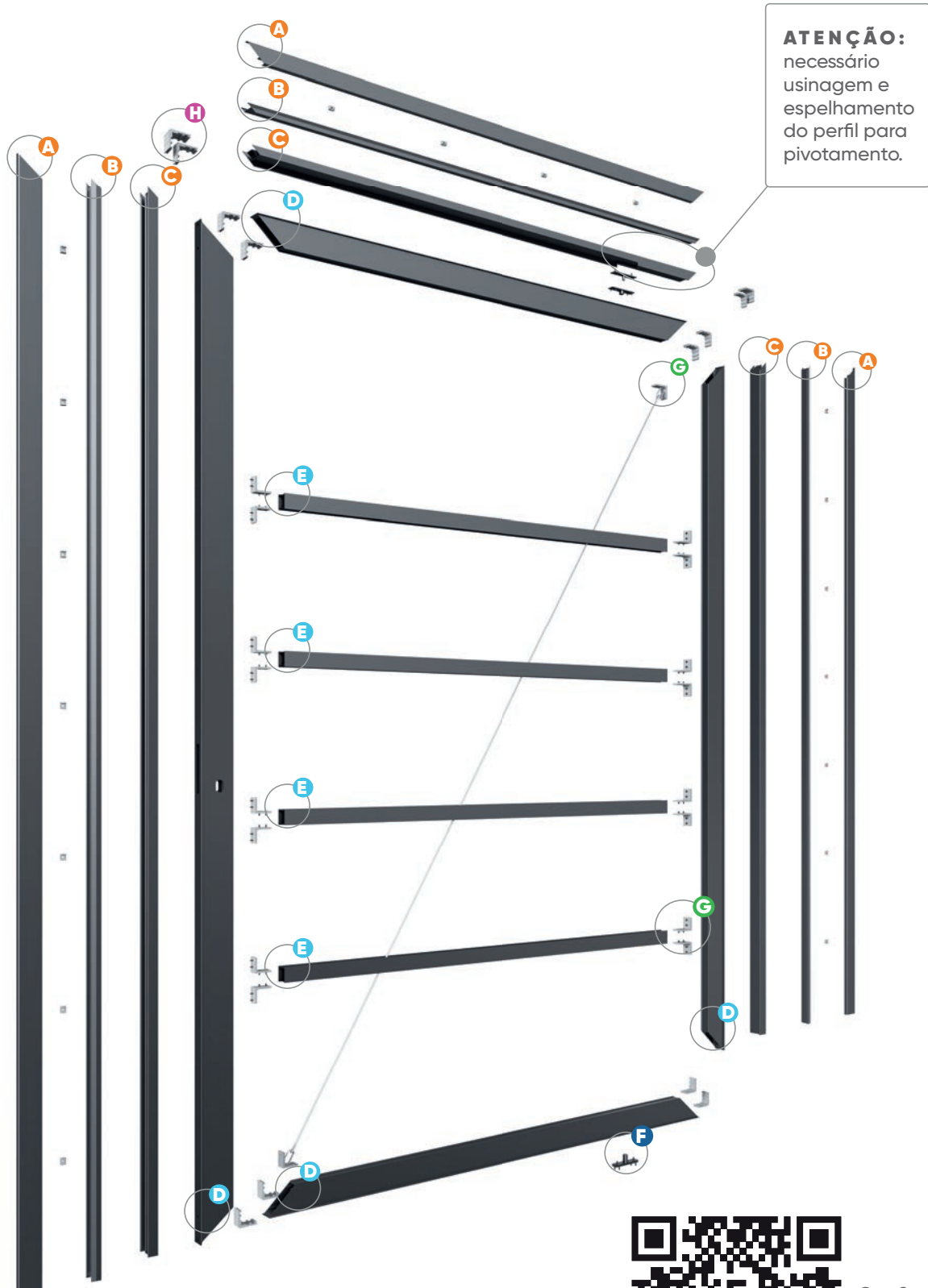

Cores disponíveis

Pintura Eletrostática

- Branco
- Preto ório

Anodizado

- Fosco
- Bronze 1001
- Bronze 1002



Confira a demonstração de montagem de uma Alumaticonte Ísis em nosso canal do Youtube.

Ísis 42 - Para portas de até 2x3m

Com os perfis e componentes abaixo, você poderá montar uma porta pivotante de até 2x3m.

Estrutura externa
(marco, contramarco e arremate)

A
RA-050
ARREIMATE
0,266 Kg/m

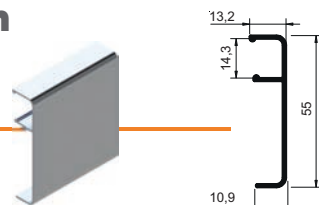

CORTE:
45°
FIXAÇÃO:
NYL-190

B
CA-060
CONTRAMARCO
0,244 Kg/m

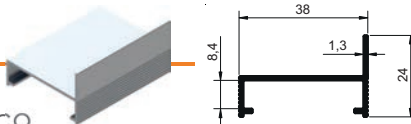

CORTE:
45°
MONTAGEM:
CAN-005
FIXAÇÃO:
CHU-787

RA-050 + CA-060
podem ser
substituídos por:

DES-1295
MARCO
0,438 Kg/m

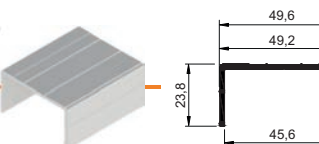

CORTE:
45°
FIXAÇÃO:
Parafuso 4,8x50mm
e bucha 8mm

C
DES-1294
MARCO
0,941 Kg/m

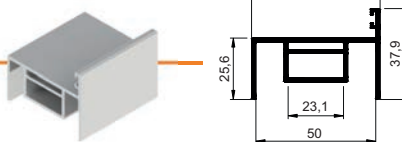

CORTE:
45°
MONTAGEM:
CAN-003
FIXAÇÃO:
Parafuso 3,9x16mm

D
DES-1293
MONTANTES e
TRAVESSAS
EXTERNAS
2,450 Kg/m

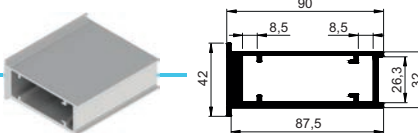

CORTE:
45°
MONTAGEM:
CAN-004
FIXAÇÃO:
PIV-0350IN

Estrutura da porta
(folha |
parte móvel)

E
DES-1483
TRAVESSAS
CENTRAIS
1,246 Kg/m

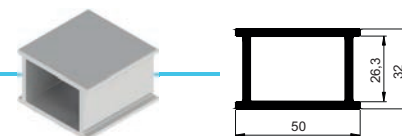

CORTE:
Reto
FIXAÇÃO:
CAN-008

E
DES-1482
TRAVESSAS
CENTRAIS
1,280 Kg/m

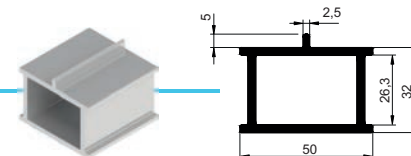

CORTE:
Reto
FIXAÇÃO:
CAN-008

E
DES-1481
TRAVESSAS
CENTRAIS
1,315 Kg/m

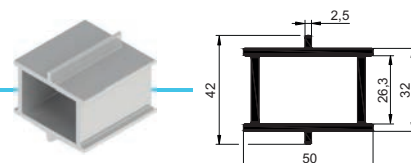

CORTE:
Reto
FIXAÇÃO:
CAN-008

Puxador

DES-2076
MONTANTE
PUXADOR USINADO
42 P / LED
2,160 Kg/m

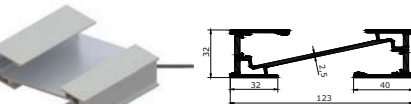

CORTE:
Reto
FIXAÇÃO:
CAN-008

G Tirante e Cantoneiras

- Ísis-001 - Esticador | Ísis-002 - Braçadeira | Ísis-003 - Tirante de aço 1/4";
- CAN-009 - Cantoneira de 2"x5/16"x26mm, com argola para aplicação do tirante;
- CAN-008 - Cantoneira de 2"x5/16"x26mm, para fixação das travessas centrais dos montantes.

F Pivô

PIV-0350IN | PIVÔ



H Canto e Cunha

CAN -003 | CAN-004 | CAN-005

Ísis 55 - Para portas de até 2x5,2m

Com os perfis e componentes abaixo, você poderá montar uma porta pivotante de até 2x5,2m.

Estrutura externa (marco, contramarco e arremate)

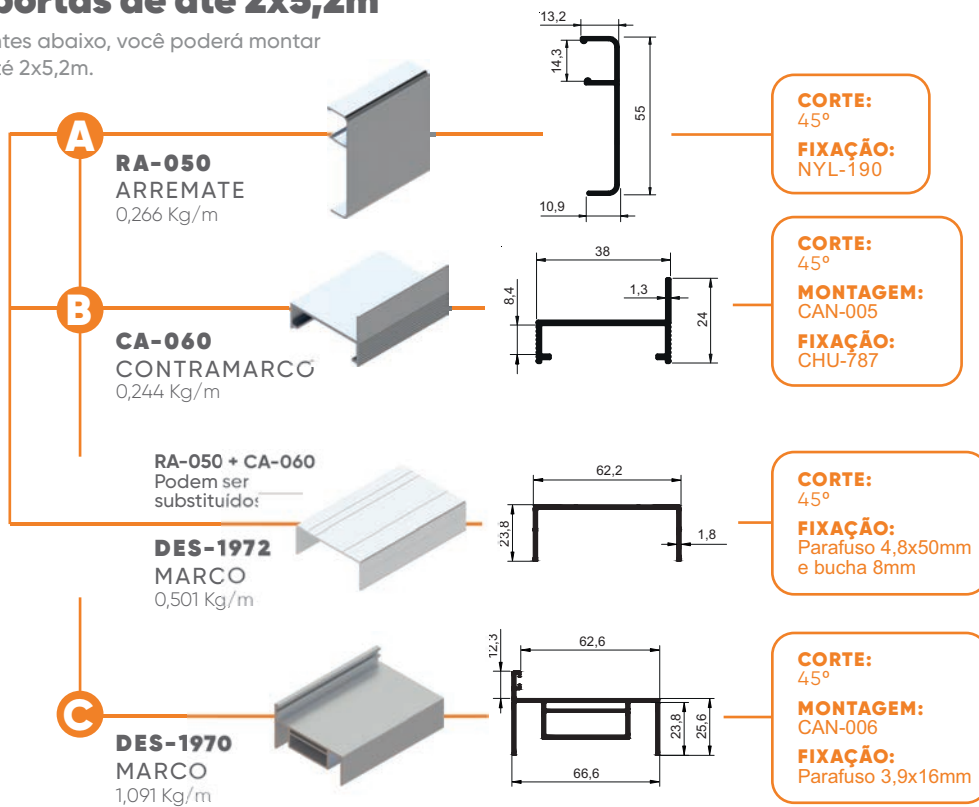

Estrutura da porta (folha | parte móvel)

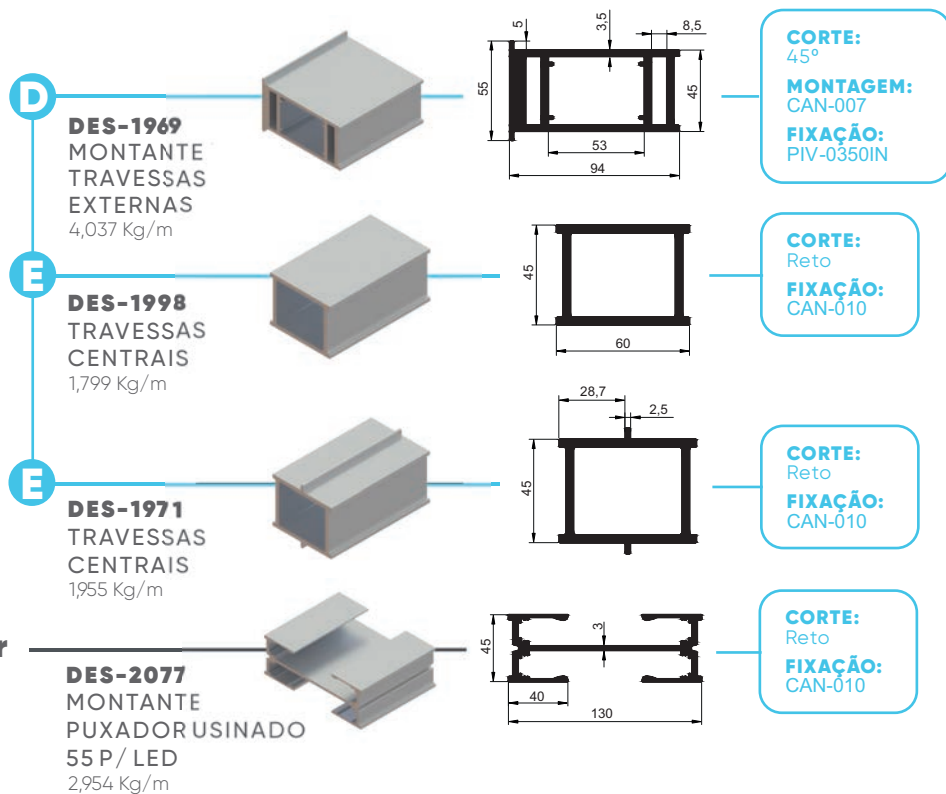

G Tirante e Cantoneiras

- ÍSIS-001 - Esticador | ÍSIS-002 - Braçadeira | ÍSIS-004 - Tirante de aço 1/4";
- CAN-011 - Cantoneira de 2"x5/16"x26mm, com argola para aplicação do tirante;
- CAN-010 - Cantoneira de 2"x5/16"x26mm, para fixação das travessas centrais dos montantes.

H Canto e Cunha

CAN -006 | CAN-007

F Pivô

PIV-0350IN | PIVÔ



NORMAS ABNT

A Associação Brasileira de Normas Técnicas (ABNT) é o órgão responsável pela normatização técnica no Brasil, fornecendo insumos ao desenvolvimento tecnológico brasileiro. Trata-se de uma entidade privada, sem fins lucrativos e de utilidade pública, fundada em 1940.

Todos os produtos desenvolvidos e produzidos pela Alumiconte contidos neste catálogo seguem rigorosamente, entre outras, as seguintes normas ABNT:

- **NBR 8116:** Alumínio e suas Ligas | Produtos Extrudados | Tolerâncias Dimensionais.
- **NBR 12609:** Alumínio e suas Ligas | Anodização para Fins Arquitetônicos | Requisitos.
- **NBR 14125:** Alumínio e suas Ligas | Tratamento de Superfícies | Revestimento Orgânico para Fins Arquitetônicos | Requisitos.



Grande como as minhas ideias.



ALUMICONTE

TEL. +55 (54) 3447-4000

RUA CONDE DE PORTO ALEGRE, 1000 - VILA FLORES/RS

WWW.ALUMICONTE.COM.BR

4ª EDIÇÃO • 2024 • REVISÃO 21

Você encontra a versão atualizada deste catálogo em nosso site,
www.alumicone.com.br



ALUMICONTE



ALUMICONTE