



# *Linha Moveleira*

CATÁLOGO GERAL

 **ALUMICONTE**



# ALUMICONTE

5.<sup>a</sup> EDIÇÃO • 2026 • REVISÃO 02

Você encontra a versão atualizada deste catálogo  
em nosso site, [www.alumicone.com.br](http://www.alumicone.com.br)



**Alumicone**

[alumicone@alumicone.com.br](mailto:alumicone@alumicone.com.br)

R. Conde de Porto Alegre, 1000 | Vila Flores | Rio Grande do Sul | Brasil

A ÚNICA  
**EMPRESA**  
NO **BRASIL**  
A PRODUZIR  
COMPONENTES,  
PERFIS E  
PERSIANAS

Fundada em 1988, a Alumiconte conta com amplo portfólio de componentes e persianas para esquadrias, além de perfis para indústria moveleira e construção civil, dispondo de processo próprio de anodização, pintura eletrostática e sublimação para acabamento dos produtos.

Destaca-se pela qualidade dos produtos e serviços prestados, resultado da dedicação em todas as etapas do processo produtivo, e pela assistência técnica especializada que oferece aos clientes, **elaborando soluções** que se adaptam perfeitamente aos projetos.



São mais de:

**37 anos**  
de experiência no setor

**4.500**  
itens

**25.000m<sup>2</sup>**  
de área fabril



## RESPEITO AO MEIO AMBIENTE

A empresa atende às diretrizes e os compromissos ambientais gerados nas esferas municipal, estadual e federal, atendendo os requisitos da Norma Internacional **ISO 14001:2015 - Gestão Ambiental**, na qual é certificada. Implantou em 1999 uma estação de tratamento de efluentes líquidos industriais com área construída de 1.158m<sup>2</sup>, além de:

- 1.** Priorizar a redução na geração de resíduos.
- 2.** Implantar técnicas de tratamento e disposição com baixo consumo de energia e espaço físico.
- 3.** Sempre que possível optar pelo reúso e/ou pela reciclagem.
- 4.** Operar o processo produtivo maximizando as tecnologias limpas.
- 5.** Gerenciar os resíduos, preservando assim, a qualidade ambiental e socioeconômica da comunidade na qual estamos inseridos.



## COMPROMISSO TOTAL COM A QUALIDADE

São premissas básicas da **Alumiconte** atuar na melhoria contínua de nossos produtos e processos, atendendo os requisitos da norma Internacional **ISO 9001:2015 - Gestão da Qualidade**, na qual é certificada, entre outras normas da ABNT - Associação Brasileira de Normas Técnicas, sempre que aplicáveis, visando o atendimento das necessidades e expectativas dos nossos clientes e partes interessadas, além de estimular, motivar e capacitar os colaboradores a participarem e se comprometerem com os **Programas de Qualidade** em todos os níveis do processo, garantindo assim, produtos com alto padrão de qualidade e a satisfação dos clientes.





## EXTRUSÃO DE ALUMÍNIO

A extrusão é um processo de produção de componentes mecânicos de forma semicontínua, no qual o alumínio é forçado através de uma matriz, adquirindo assim a forma predeterminada de acordo com a necessidade. Perfis de alumínio são utilizados nos ramos de construção civil, indústria naval, aeroespacial, automobilística e moveleira.

Na Alomiconte, contamos com 3 grandes extrusoras de alumínio, voltados a atender a construção civil, setor moveleiro e industrial.

### CONSTRUÇÃO CIVIL

Perfis voltados para a produção de esquadrias, oferecemos ampla gama de produtos, atendendo de forma eficiente às necessidades do serralheiro, entregando alto padrão estético, de qualidade e funcionalidade.

### INDÚSTRIA MOVELEIRA

Em nosso portfólio de itens voltados para indústria moveleira, você encontra mais de 600 produtos em linha, que atendem a inúmeras formas e aplicações.

### PERFIS PERSONALIZADOS

Dispomos de setor de engenharia focado na busca pela solução ideal para cada projeto, produzindo perfis personalizados, de acordo com o design e necessidade do cliente.



### ESCOVADO

O alumínio anodizado e escovado da Alumiconte veio para agregar ainda mais requinte e diferenciação aos seus ambientes.

Antes de ser anodizado, o perfil é submetido ao processo de escovação, que confere ao produto uma superfície com textura elegante e sofisticada.

#### CORES

Bronze 1003	Inox
Bronze 1002	Preto
Bronze 1001	Fosco



### JATEAMENTO

A Alumiconte conta com um grande diferencial no mercado quando o assunto é alumínio jateado, pois o nosso processo é mecânico, ou seja, acontece a partir do contato entre microesferas e o perfil, resultando em uma superfície de aspecto aveludado e sem quaisquer marcas.

**A BASE PERFEITA PARA POSTERIOR ANODIZAÇÃO.**  
Juntos, transformam o alumínio em um elemento essencial para o design do projeto.



## ANODIZAÇÃO

A anodização é um processo eletroquímico que transforma a superfície do alumínio em óxido de alumínio, aumentando sua resistência à corrosão e proporcionando um acabamento estético singular. Variações de tonalidade dentro de um mesmo padrão são naturais devido às variáveis do processo.

Este é um dos processos mais utilizados em perfis para o setor moveleiro, que ganha ainda mais beleza quando combinado à escovação ou jateamento.

### CORES

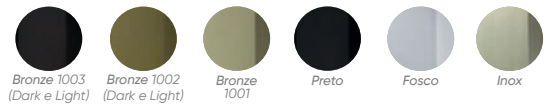

## PINTURA ELETROSTÁTICA

Perfeição de cobertura e acabamento são diferenciais da pintura eletrostática, além da resistência à abrasão e corrosão, bem como sua durabilidade perante exposição à intempéries (raios solares, calor, frio e umidade).

Este processo confere ao produto uma superfície lisa e de fácil higienização, combinados à alta durabilidade e aspecto impecável.

### CORES

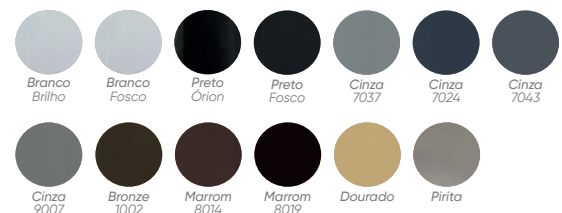

### Microtexturizados



Obs.: devido à impressão, podem ocorrer variações de tonalidade entre as amostras de cores do catálogo e produto físico.



## ALUMICONTE **MADLOR**

A Alumiconte **Madlor** é uma nova coleção de acabamentos amadeirados, com um processo de **sublimação** completo realizado na Alumiconte.

- Único sistema no mundo a oferecer **10 anos de garantia** na combinação de base + filme, além de contar com certificações Qualicoat e Qualideco.
- Conta com **Test in Flórida**, que garante a eficiência do acabamento.
- Tinta à base de **PU**, a mais eficiente do mercado para processo de sublimação.
- Acabamento **perfeito**, abrangendo todas as regiões da geometria do perfil.
- Variedade de acabamentos para todos os Perfis de Construção Civil e Moveleiro da Alumiconte.

*Uma nova proposta que irá trazer mais beleza e sofisticação aos seus projetos.*



Confira as cores disponíveis em nosso catálogo:



*Madlor Bambu Dourado*



*Madlor Bétula Marfim*

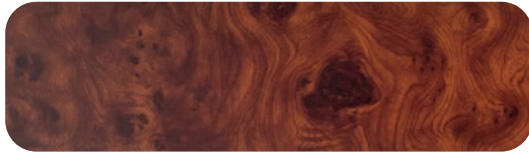

*Madlor Briar Marrom*



*Madlor Carvalho Branco*



*Madlor Carvalho Louro*



*Madlor Carvalho Marrom*

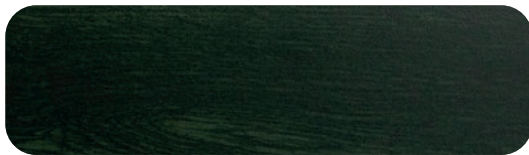

*Madlor Carvalho Verde*



*Madlor Castanha Café*



*Madlor Castanha Dourada*



*Madlor Castanha Sépia*

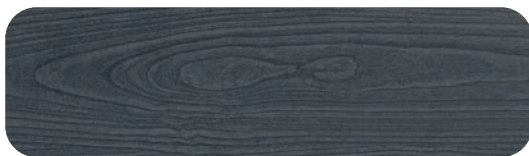

*Madlor Cerejeira Cinza*



*Madlor Cerejeira Marrom*



*Madlor Cerejeira Negra*



*Madlor Mogno Carmim*

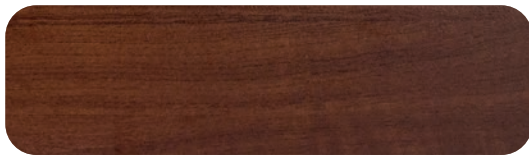

*Madlor Mogno Marrom*



*Madlor Pinus Dourado*

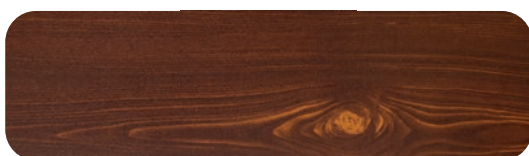

*Madlor Pinus Marrom*

Obs.: devido à impressão, podem ocorrer variações de tonalidade entre as amostras de cores do catálogo e produto físico.

IMPORTANTE: Os acabamentos sublimados são indicados para as ligas de alumínio 6060 e 6063. Para outras ligas, é necessário realizar testes prévios para validação da aplicação.

# REFFINE

CANETA CORRETIVA



A caneta Reffine da Alumiconte foi desenvolvida para retocar marcas e arranhões nas bordas e cantos de peças, refinando o acabamento da esquadria de forma prática e rápida.

Além disso, ela é ideal para realizar o selamento no corte do perfil e bordas expostas. O resultado é um visual uniforme, e grande redução na perda de alumínio por pequenas avarias!



CORES DISPONÍVEIS:



Branco



Preto



Cinza  
RAL 7037



Saiba mais sobre a caneta Reffine acessando o QR Code ao lado.

# ÍNDICE POR MODELO

## Perfil Puxador Oculto

---

DES-173..... 16	DES-404..... 16	DES-1270..... 17	DES-1431..... 17
DES-224..... 17	DES-933..... 17	DES-1404..... 17	DES-1432..... 17
DES-345..... 16	DES-1011..... 16	DES-1405..... 17	

## Perfil Puxador Oculto com Espiga

---

DES-022..... 18	DES-094..... 18	DES-1272..... 18
-----------------	-----------------	------------------

## Perfil Puxador Testeira com Espiga

---

DES-622..... 19	DES-623..... 19	DES-1273..... 19	DES-1696..... 19	DES-2167..... 19
-----------------	-----------------	------------------	------------------	------------------

## Perfil Puxador Gola

---

DES-009..... 20	DES-202..... 20	DES-270..... 20	DES-385..... 22	DES-1400..... 21
DES-074..... 22	DES-212..... 21	DES-275..... 21	DES-620..... 22	DES-1401..... 21
DES-089..... 22	DES-213..... 21	DES-284..... 21	DES-621..... 22	
DES-197..... 21	DES-214..... 20	DES-312..... 21	DES-949..... 22	
DES-201..... 22	DES-264..... 20	DES-339..... 20	DES-960..... 20	

## Perfil Puxador Gola com Espiga

---

DES-142..... 23	DES-238..... 23	DES-314..... 23	DES-611..... 23
-----------------	-----------------	-----------------	-----------------

## Perfil Puxador de Correr MDF

---

DES-102..... 24	DES-162..... 24	DES-222..... 24	DES-291..... 24	DES-307..... 24
-----------------	-----------------	-----------------	-----------------	-----------------

## Perfil Quadro de Vidro

---

DES-001.....37	DES-187..... 35	DES-721.....37	DES-1075.....33	DES-1414..... 41
DES-002..... 38	DES-198..... 30	DES-730..... 30	DES-1093..... 29	DES-1419..... 32
DES-007.....37	DES-204..... 30	DES-856..... 30	DES-1094..... 29	DES-1451..... 41
DES-010..... 38	DES-225..... 28	DES-856..... 36	DES-1225.....27	DES-1489..... 34
DES-011..... 35	DES-226..... 28	DES-875.....37	DES-1226.....27	DES-1490..... 34
DES-012..... 35	DES-227..... 28	DES-877..... 30	DES-1227.....27	DES-1491..... 34
DES-014..... 36	DES-232.....33	DES-897..... 30	DES-1228.....27	DES-1492..... 34
DES-015..... 42	DES-233.....33	DES-902.....39	DES-1250.....37	DES-1612.....39
DES-016.....39	DES-247..... 36	DES-912.....27	DES-1264..... 31	DES-1697.....33
DES-017..... 42	DES-279..... 36	DES-912..... 28	DES-1265..... 35	DES-1789..... 32
DES-019..... 42	DES-282..... 30	DES-929.....37	DES-1268..... 31	DES-1934.....39
DES-026..... 35	DES-297.....39	DES-950..... 30	DES-1271..... 28	DES-2074..... 40
DES-060.....39	DES-311..... 31	DES-951..... 36	DES-1279.....39	DES-2075..... 40
DES-062..... 38	DES-313..... 35	DES-952..... 36	DES-1291..... 42	DES-2192..... 32
DES-073..... 41	DES-318.....37	DES-953..... 41	DES-1321..... 41	DES-2193..... 32
DES-077..... 36	DES-320..... 35	DES-1012..... 35	DES-1326..... 38	DES-2349.....33
DES-078..... 36	DES-370..... 31	DES-1016..... 31	DES-1328..... 38	DES-2350..... 34
DES-084.....37	DES-530..... 38	DES-1042..... 29	DES-1402..... 31	DES-2351..... 34
DES-133..... 38	DES-550..... 38	DES-1043..... 29	DES-1403..... 31	DES-2425..... 41
DES-147..... 41	DES-691..... 32	DES-1073.....33	DES-1407..... 34	DES-3098..... 41
DES-178..... 42	DES-692..... 32	DES-1074.....33	DES-1408..... 34	

# ÍNDICE POR MODELO

## Perfil **Puxador de Encaixe**

---

DES-043..... 43	DES-395 ..... 45	DES-1251..... 43	DES-1332..... 45	DES-2347 ..... 46
DES-112..... 44	DES-519 ..... 43	DES-1278 ..... 44	DES-1420 ..... 44	DES-2348..... 46
DES-148..... 44	DES-842..... 44	DES-1299..... 45	DES-1613..... 43	DES-2822 ..... 46
DES-203..... 44	DES-901..... 45	DES-1319..... 45	DES-1614..... 43	DES-2892..... 46
DES-239 ..... 43	DES-909..... 44	DES-1324..... 45	DES-2184 ..... 43	
DES-296 ..... 45	DES-993 ..... 44	DES-1329..... 45	DES-2185..... 43	

## Alumiconte **Armo**

---

ARM-062..... 48	ARM-530 ..... 48	DES-239 ..... 48
ARM-198..... 48	ARM-3047..... 48	DES-395 ..... 48

## Perfil **Armário com Iluminação Interna**

---

DES-161..... 50	DES-1478..... 50	DES-1488 ..... 50	DES-1492..... 51
DES-600 ..... 51	DES-1479..... 50	DES-1489 ..... 51	DES-1899..... 50
DES-1016 ..... 51	DES-1480 ..... 50	DES-1490 ..... 51	DES-2428..... 51
DES-1477..... 50	DES-1487..... 50	DES-1491 ..... 51	DES-3002 ..... 51

## Perfil **Painel Movie**

---

DES-851..... 54	DES-852 ..... 54	DES-1298..... 54	DES-1303 ..... 54
-----------------	------------------	------------------	-------------------

## Alumiconte **Ísis**

---

CA-0060.....57	DES-1295.....57	DES-1969 ..... 60	DES-1998..... 60	RA-0050 .....59
CA-0060.....59	DES-1481 ..... 58	DES-1970.....59	DES-2076 ..... 58	
DES-1293.....57	DES-1482..... 58	DES-1971..... 60	DES-2077 ..... 60	
DES-1294.....57	DES-1483..... 58	DES-1972 .....59	RA-0050 .....57	

## Perfil **Porta de Passagem**

---

DES-036.....62	DES-039 .....62	DES-167 .....62	DES-261 .....62
DES-037 .....62	DES-044 .....62	DES-200 .....62	DES-886.....62

## Perfil **Porta de Passagem de Vidro**

---

BXT-505 ..... 64	DES-600 ..... 65	DES-1512..... 64	DES-1518 ..... 66	DES-1722 ..... 64
DES-597..... 65	DES-1302 ..... 64	DES-1514 ..... 64	DES-1519..... 66	DES-2343..... 65
DES-598 ..... 65	DES-1510 ..... 64	DES-1516..... 66	DES-1526..... 66	DES-2344 ..... 65
DES-599 ..... 65	DES-1511 ..... 64	DES-1517..... 66	DES-1721..... 64	

## Perfil **Porta de Correr**

---

DES-032..... 70	DES-058.....69	DES-294 .....69	DES-524 .....69	DES-980..... 68
DES-035..... 68	DES-113.....69	DES-309..... 71	DES-601..... 70	DES-992 ..... 68
DES-038.....69	DES-155..... 68	DES-315 ..... 68	DES-603..... 70	DES-1284 ..... 71
DES-041 ..... 68	DES-156.....69	DES-344..... 70	DES-820..... 71	DES-1433..... 68
DES-042..... 71	DES-188..... 71	DES-390.....69	DES-843..... 70	DES-1434 ..... 70
DES-051..... 70	DES-228 ..... 70	DES-511.....69	DES-844..... 71	
DES-055..... 68	DES-287 .....69	DES-512 .....69	DES-944..... 68	

# ÍNDICE POR MODELO

## Perfil Estrutural para Vidro

---

DES-257 .....72	DES-260.....72	DES-874.....72	DES-1409 .....73	DES-1412 .....73
DES-258 .....72	DES-334.....72	DES-932 .....73	DES-1410 .....73	DES-1413 .....73
DES-259 .....72	DES-400 .....73	DES-1304 .....73	DES-1411 .....73	DES-1445 .....73

## Perfil Testeira e Emenda

---

DES-165.....74	DES-241.....75	DES-596.....74	DES-1620 .....75	DES-3005 .....76
DES-171.....74	DES-248.....74	DES-616 .....75	DES-2089.....75	DES-3006 .....76
DES-205.....74	DES-249 .....74	DES-694 .....75	DES-2090 .....75	DES-3007 .....76
DES-240.....75	DES-292 .....74	DES-1281.....75	DES-2639 .....74	

## Perfis Ripados

---

ALV-2511 ..... 82	ALV-2513..... 81	ALV-2582.....79	ALV-2584 .....79	DES-1290 ..... 81
ALV-2512..... 82	ALV-2518 ..... 82	ALV-2583.....79	ALV-2585.....79	

## Perfis Trilhos para Esquadria de Madeira

---

DES-006 ..... 83	DES-029 ..... 84	DES-034..... 84	DES-164..... 83	DES-876..... 84
DES-027 ..... 83	DES-031..... 84	DES-040 ..... 84	DES-166 ..... 84	
DES-028..... 83	DES-033..... 83	DES-059 ..... 83	DES-242 ..... 83	

## Perfis Diversos

---

DES-052..... 86	DES-181.....87	DES-1254..... 88	DES-1515 .....87	DES-2261 ..... 86
DES-093.....87	DES-271 ..... 86	DES-1443 .....87	DES-1816.....87	
DES-161..... 86	DES-880.....87	DES-1444 .....87	DES-1899..... 86	
DES-163..... 86	DES-1253..... 88	DES-1458 .....87	DES-2259 ..... 89	

## Perfis Tubulares | Barras Chatas | Cantoneiras

---

ALU-043..... 91	BXT-499..... 90	DES-243 ..... 91	DES-386 ..... 90	DES-998 ..... 90
ALU-044..... 91	BXT-500..... 90	DES-244..... 91	DES-496 ..... 90	DES-1016 ..... 90
BXT-483..... 91	DES-086..... 91	DES-255 ..... 90	DES-602..... 90	DES-1026 ..... 90
BXT-484 ..... 91	DES-087 ..... 91	DES-256 ..... 90	DES-677 ..... 90	DES-1040..... 90
BXT-485 ..... 91	DES-097 ..... 90	DES-267..... 91	DES-678..... 90	DES-1297 ..... 90
BXT-497 ..... 90	DES-140 ..... 91	DES-289 ..... 90	DES-742 ..... 91	DES-1455..... 90
BXT-498..... 91	DES-151..... 91	DES-319 ..... 91	DES-873 ..... 91	DES-1923..... 90

# ÍNDICE GERAL

ALU-043..... 91	DES-074 .....22	DES-257 ..... 72	DES-691.....32	DES-1270.....17	DES-1492..... 34
ALU-044..... 91	DES-077 .....36	DES-258 ..... 72	DES-692 ..... 32	DES-1271.....28	DES-1492.....51
ALV-2511 .....82	DES-078 .....36	DES-259 ..... 72	DES-694 ..... 75	DES-1272 ..... 18	DES-1510 ..... 64
ALV-2512 .....82	DES-084 ..... 37	DES-260 ..... 72	DES-721..... 37	DES-1273 ..... 19	DES-1511 ..... 64
ALV-2513 .....81	DES-086 ..... 91	DES-261 ..... 62	DES-730 ..... 30	DES-1278 ..... 44	DES-1512 ..... 64
ALV-2518 .....82	DES-087 ..... 91	DES-264 ..... 20	DES-742 ..... 91	DES-1279 ..... 39	DES-1514 ..... 64
ALV-2582 .....79	DES-089 .....22	DES-267 ..... 91	DES-820 .....71	DES-1281 ..... 75	DES-1515 .....87
ALV-2583 .....79	DES-093 ..... 87	DES-270 ..... 20	DES-842 ..... 44	DES-1284 ..... 71	DES-1516 .....66
ALV-2584 .....79	DES-094 ..... 18	DES-271 ..... 86	DES-843 ..... 70	DES-1290 ..... 81	DES-1517 .....66
ALV-2585 .....79	DES-097 ..... 90	DES-275 .....21	DES-844 .....71	DES-1291 .....42	DES-1518 .....66
ARM-062 ..... 48	DES-102 ..... 24	DES-279 ..... 36	DES-851 ..... 54	DES-1293 ..... 57	DES-1519 .....66
ARM-198 ..... 48	DES-112 ..... 44	DES-282 ..... 30	DES-852 ..... 54	DES-1294 ..... 57	DES-1526 .....66
ARM-530 ..... 48	DES-113 ..... 69	DES-284 .....21	DES-856 ..... 30	DES-1295 ..... 57	DES-1612 .....39
ARM-3047 ..... 48	DES-133 ..... 38	DES-287 ..... 69	DES-856 ..... 36	DES-1297 ..... 90	DES-1613 .....43
BXT-483..... 91	DES-140 ..... 91	DES-289 ..... 90	DES-873 ..... 91	DES-1298 ..... 54	DES-1614 .....43
BXT-484 ..... 91	DES-142 ..... 23	DES-291 ..... 24	DES-874 ..... 72	DES-1299 ..... 45	DES-1620 ..... 75
BXT-485 ..... 91	DES-147 ..... 41	DES-292 ..... 74	DES-875 ..... 37	DES-1302 ..... 64	DES-1696 ..... 19
BXT-497 ..... 90	DES-148 ..... 44	DES-294 ..... 69	DES-876 ..... 84	DES-1303 ..... 54	DES-1697 ..... 33
BXT-498 ..... 91	DES-151 ..... 91	DES-296 ..... 45	DES-877 ..... 30	DES-1304 ..... 73	DES-1721 ..... 64
BXT-499 ..... 90	DES-155 ..... 68	DES-297 ..... 39	DES-880 ..... 87	DES-1319 ..... 45	DES-1722 ..... 64
BXT-500 ..... 90	DES-156 ..... 69	DES-307 ..... 24	DES-881 ..... 25	DES-1321 ..... 41	DES-1789 ..... 32
BXT-505 ..... 64	DES-161 ..... 50	DES-309 ..... 71	DES-886 ..... 62	DES-1324 ..... 45	DES-1816 ..... 87
CA-0060 ..... 57	DES-161 ..... 86	DES-311 ..... 31	DES-897 ..... 30	DES-1326 ..... 38	DES-1899 ..... 50
CA-0060 ..... 59	DES-162 ..... 24	DES-312 ..... 21	DES-901 ..... 45	DES-1328 ..... 38	DES-1899 ..... 86
DES-001 ..... 37	DES-163 ..... 86	DES-313 ..... 35	DES-902 ..... 39	DES-1329 ..... 45	DES-1923 ..... 90
DES-002 ..... 38	DES-164 ..... 83	DES-314 ..... 23	DES-909 ..... 44	DES-1332 ..... 45	DES-1934 ..... 39
DES-006 ..... 83	DES-165 ..... 74	DES-315 ..... 68	DES-912 ..... 27	DES-1400 ..... 21	DES-1969 ..... 60
DES-007 ..... 37	DES-166 ..... 84	DES-318 ..... 37	DES-912 ..... 28	DES-1401 ..... 21	DES-1970 ..... 59
DES-009 ..... 20	DES-167 ..... 62	DES-319 ..... 91	DES-929 ..... 37	DES-1402 ..... 31	DES-1971 ..... 60
DES-010 ..... 38	DES-171 ..... 74	DES-320 ..... 35	DES-932 ..... 73	DES-1403 ..... 31	DES-1972 ..... 59
DES-011 ..... 35	DES-173 ..... 16	DES-334 ..... 72	DES-933 ..... 17	DES-1404 ..... 17	DES-1998 ..... 60
DES-012 ..... 35	DES-178 ..... 42	DES-339 ..... 20	DES-944 ..... 68	DES-1405 ..... 17	DES-2074 ..... 40
DES-014 ..... 36	DES-181 ..... 87	DES-344 ..... 70	DES-949 ..... 22	DES-1407 ..... 34	DES-2075 ..... 40
DES-015 ..... 42	DES-187 ..... 35	DES-345 ..... 16	DES-950 ..... 30	DES-1408 ..... 34	DES-2076 ..... 58
DES-016 ..... 39	DES-188 ..... 71	DES-347 ..... 25	DES-951 ..... 36	DES-1409 ..... 73	DES-2077 ..... 60
DES-017 ..... 42	DES-197 ..... 21	DES-370 ..... 31	DES-952 ..... 36	DES-1410 ..... 73	DES-2089 ..... 75
DES-019 ..... 42	DES-198 ..... 30	DES-385 ..... 22	DES-953 ..... 41	DES-1411 ..... 73	DES-2090 ..... 75
DES-022 ..... 18	DES-200 ..... 62	DES-386 ..... 90	DES-960 ..... 20	DES-1412 ..... 73	DES-2167 ..... 19
DES-026 ..... 35	DES-201 ..... 22	DES-390 ..... 69	DES-980 ..... 68	DES-1413 ..... 73	DES-2184 ..... 43
DES-027 ..... 83	DES-202 ..... 20	DES-395 ..... 45	DES-992 ..... 68	DES-1414 ..... 41	DES-2185 ..... 43
DES-028 ..... 83	DES-203 ..... 44	DES-395 ..... 48	DES-993 ..... 44	DES-1419 ..... 32	DES-2192 ..... 32
DES-029 ..... 84	DES-204 ..... 30	DES-400 ..... 73	DES-998 ..... 90	DES-1420 ..... 44	DES-2193 ..... 32
DES-031 ..... 84	DES-205 ..... 74	DES-404 ..... 16	DES-1011 ..... 16	DES-1431 ..... 17	DES-2259 ..... 89
DES-032 ..... 70	DES-212 ..... 21	DES-496 ..... 90	DES-1012 ..... 35	DES-1432 ..... 17	DES-2261 ..... 86
DES-033 ..... 83	DES-213 ..... 21	DES-511 ..... 69	DES-1016 ..... 31	DES-1433 ..... 68	DES-2343 ..... 65
DES-034 ..... 84	DES-214 ..... 20	DES-512 ..... 69	DES-1016 ..... 51	DES-1434 ..... 70	DES-2344 ..... 65
DES-035 ..... 68	DES-222 ..... 24	DES-519 ..... 43	DES-1016 ..... 90	DES-1443 ..... 87	DES-2347 ..... 46
DES-036 ..... 62	DES-224 ..... 17	DES-524 ..... 69	DES-1026 ..... 90	DES-1444 ..... 87	DES-2348 ..... 46
DES-037 ..... 62	DES-225 ..... 28	DES-530 ..... 38	DES-1040 ..... 90	DES-1445 ..... 73	DES-2349 ..... 33
DES-038 ..... 69	DES-226 ..... 28	DES-550 ..... 38	DES-1042 ..... 29	DES-1451 ..... 41	DES-2350 ..... 34
DES-039 ..... 62	DES-227 ..... 28	DES-596 ..... 74	DES-1043 ..... 29	DES-1455 ..... 90	DES-2351 ..... 34
DES-040 ..... 84	DES-228 ..... 70	DES-597 ..... 65	DES-1073 ..... 33	DES-1458 ..... 87	DES-2425 ..... 41
DES-041 ..... 68	DES-232 ..... 33	DES-598 ..... 65	DES-1074 ..... 33	DES-1477 ..... 50	DES-2428 ..... 51
DES-042 ..... 71	DES-233 ..... 33	DES-599 ..... 65	DES-1075 ..... 33	DES-1478 ..... 50	DES-2639 ..... 74
DES-043 ..... 43	DES-238 ..... 23	DES-600 ..... 51	DES-1093 ..... 29	DES-1479 ..... 50	DES-2822 ..... 46
DES-044 ..... 62	DES-239 ..... 43	DES-600 ..... 65	DES-1094 ..... 29	DES-1480 ..... 50	DES-2892 ..... 46
DES-046 ..... 25	DES-239 ..... 48	DES-601 ..... 70	DES-1225 ..... 27	DES-1481 ..... 58	DES-3002 ..... 51
DES-051 ..... 70	DES-240 ..... 75	DES-602 ..... 90	DES-1226 ..... 27	DES-1482 ..... 58	DES-3005 ..... 76
DES-052 ..... 86	DES-241 ..... 75	DES-603 ..... 70	DES-1227 ..... 27	DES-1483 ..... 58	DES-3006 ..... 76
DES-055 ..... 68	DES-242 ..... 83	DES-611 ..... 23	DES-1228 ..... 27	DES-1487 ..... 50	DES-3007 ..... 76
DES-058 ..... 69	DES-243 ..... 91	DES-616 ..... 75	DES-1250 ..... 37	DES-1488 ..... 50	DES-3098 ..... 41
DES-059 ..... 83	DES-244 ..... 91	DES-620 ..... 22	DES-1251 ..... 43	DES-1489 ..... 34	RA-0050 ..... 57
DES-060 ..... 39	DES-247 ..... 36	DES-621 ..... 22	DES-1253 ..... 88	DES-1489 ..... 51	RA-0050 ..... 59
DES-062 ..... 38	DES-248 ..... 74	DES-622 ..... 19	DES-1254 ..... 88	DES-1490 ..... 34	
DES-063 ..... 25	DES-249 ..... 74	DES-623 ..... 19	DES-1264 ..... 31	DES-1490 ..... 51	
DES-064 ..... 25	DES-255 ..... 90	DES-677 ..... 90	DES-1265 ..... 35	DES-1491 ..... 34	
DES-073 ..... 41	DES-256 ..... 90	DES-678 ..... 90	DES-1268 ..... 31	DES-1491 ..... 51	



## PUXADORES

Desenvolvidos para facilitar a abertura e o fechamento de portas e gavetas de móveis em geral, os perfis puxadores aliam funcionalidade, durabilidade e design moderno.

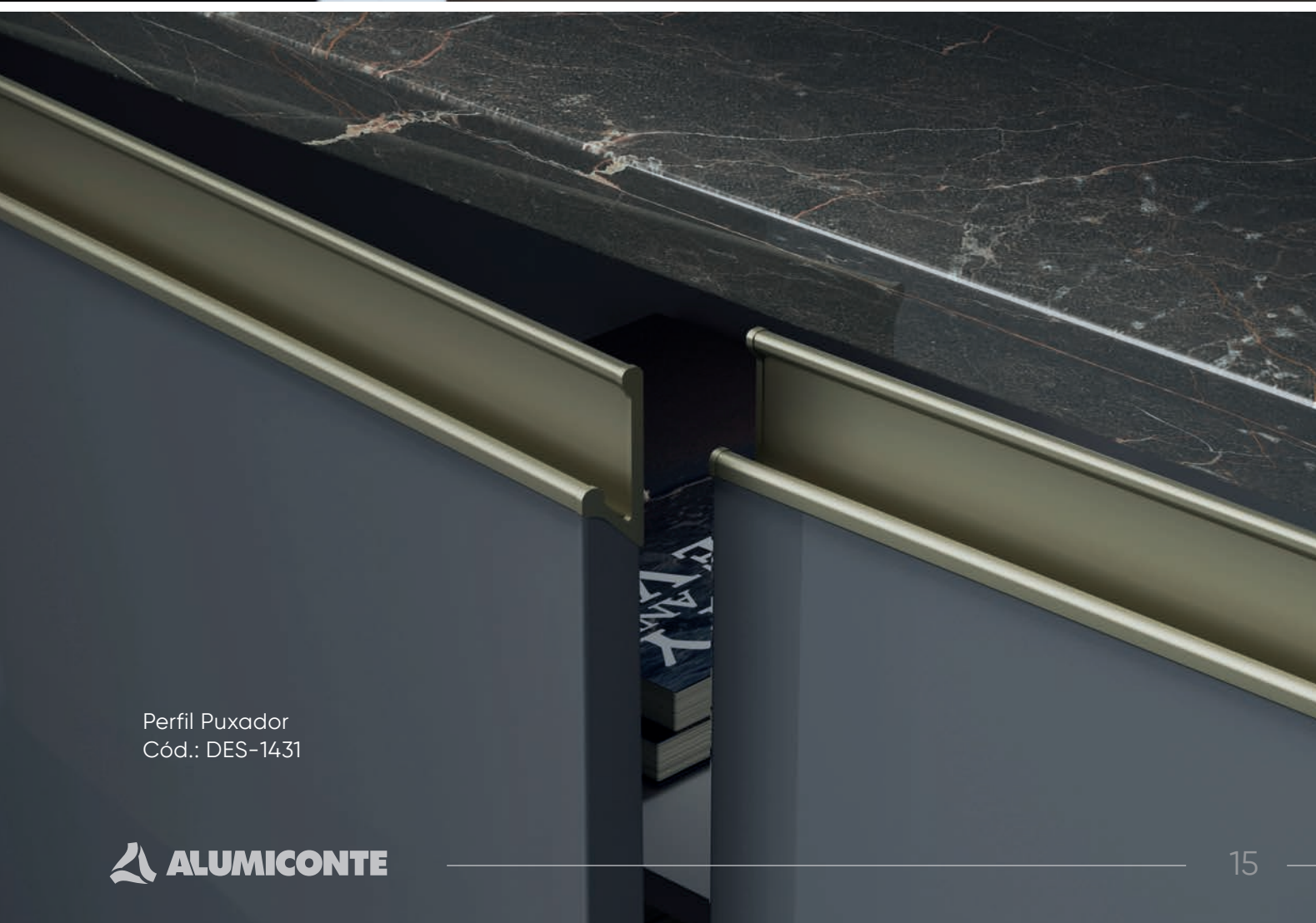

Perfil Puxador  
Cód.: DES-1431

### DES-173

Puxador de Encaixe | MDF 18 mm  
0,437 Kg/m

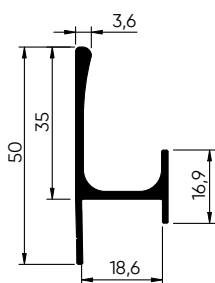
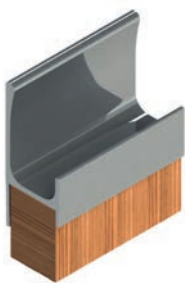

### DES-1011

Puxador de Encaixe | MDF 15 mm  
0,273 Kg/m

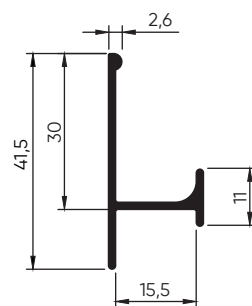

### DES-404

Puxador de Encaixe | MDF 18 mm  
0,327 Kg/m

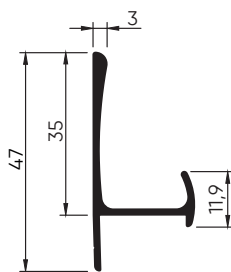

### DES-345

Puxador de Encaixe | MDF 15 mm  
0,273 Kg/m

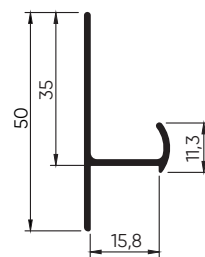

Perfil Puxador  
Cód.: DES-1011



### DES-224

Puxador de Encaixe | MDF 18 mm  
0,378 Kg/m

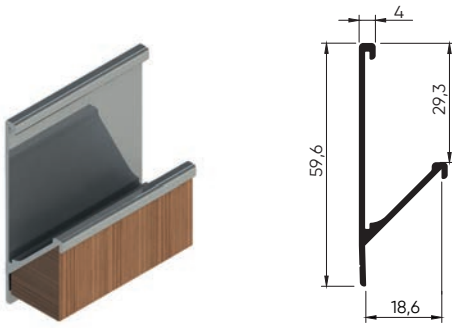

### DES-933

Puxador de Encaixe | MDF 15 mm  
0,342 Kg/m

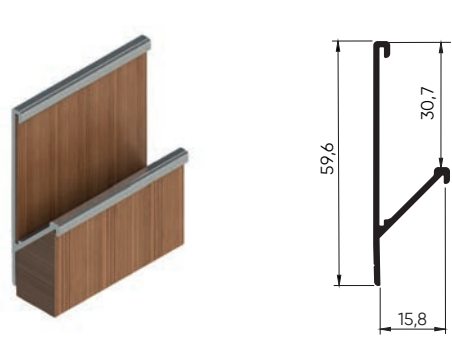

### DES-1404

Puxador de Encaixe | MDF 18 mm  
0,369 Kg/m

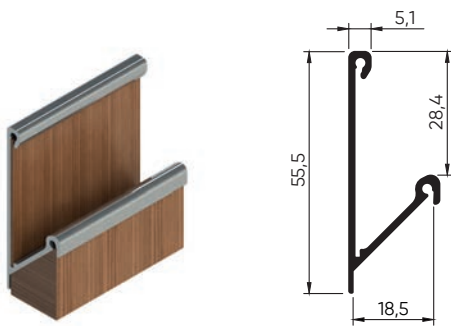

### DES-1405

Puxador de Encaixe | MDF 15 mm  
0,363 Kg/m



### DES-1432

Puxador de Encaixe | MDF 18mm  
0,397 Kg/m  
Ponteira disponível

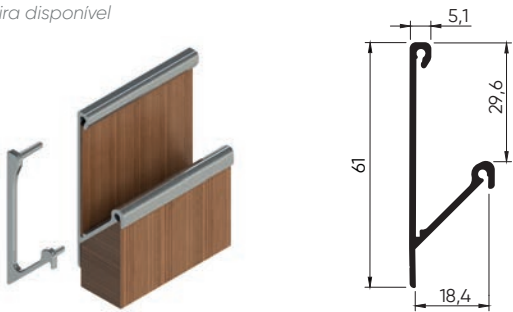

### DES-1431

Puxador de Encaixe | MDF 15mm  
0,383 Kg/m  
Ponteira disponível

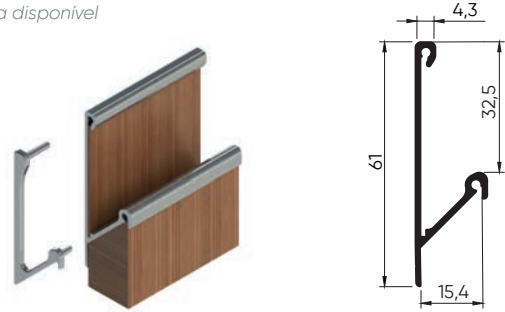

### DES-1270

Puxador de Encaixe | MDF 18mm  
0,357 Kg/m

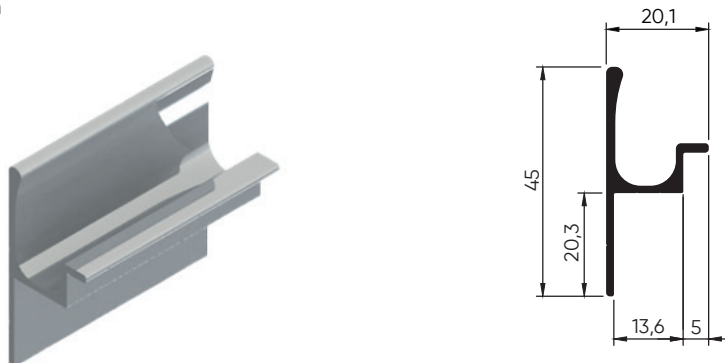

A ALUMICONTE reserva-se o direito de fazer modificações em qualquer informação escrita neste catálogo sem aviso prévio. Os desenhos aqui contidos possuem medidas teóricas de massa e tolerâncias dimensionais de acordo com a ABNT NBR-8116, podendo haver variações dessas informações no produto final.



Perfil Puxador  
com Espiga  
Cód.: DES-022

## DES-022

Puxador de Encaixe com Espiga | MDF 18 mm

0,438 Kg/m

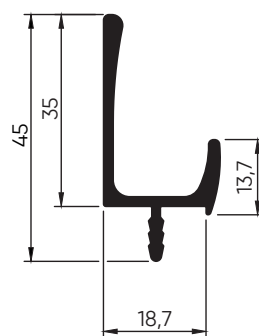

## DES-094

Puxador de Encaixe com Espiga | MDF 18 mm

0,392 Kg/m

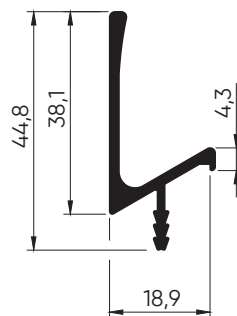

## DES-1272

Puxador de Encaixe com Espiga | MDF 18 mm

0,347 Kg/m

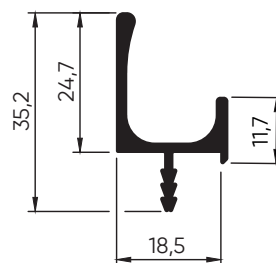
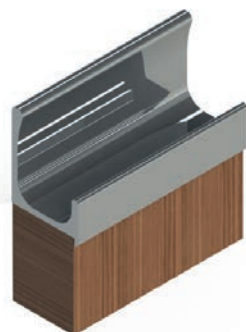

A ALUMICONTE reserva-se o direito de fazer modificações em qualquer informação escrita neste catálogo sem aviso prévio. Os desenhos aqui contidos possuem medidas teóricas de massa e tolerâncias dimensionais de acordo com a ABNT NBR-8116, podendo haver variações dessas informações no produto final.

### DES-622

Puxador de Encaixe com Espiga | MDF 18 mm  
0,505 Kg/m

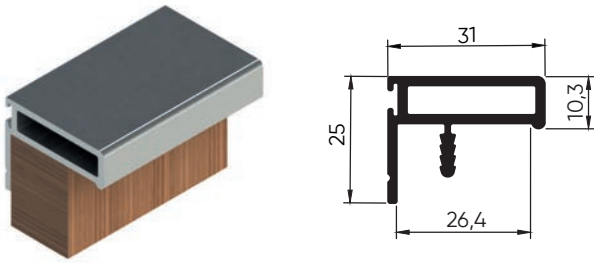

### DES-623

Puxador de Encaixe com Espiga | MDF 18 mm  
0,745 Kg/m

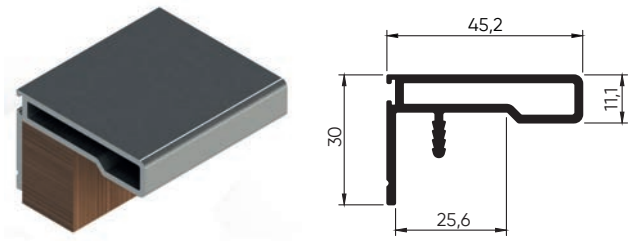

### DES-1273

Puxador de Encaixe com Espiga | MDF 18 mm  
0,290 Kg/m

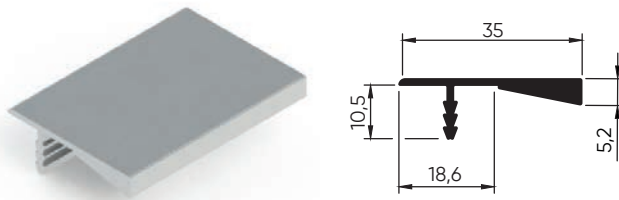

### DES-1696

Puxador de Encaixe com Espiga | MDF 18 mm  
0,268 Kg/m

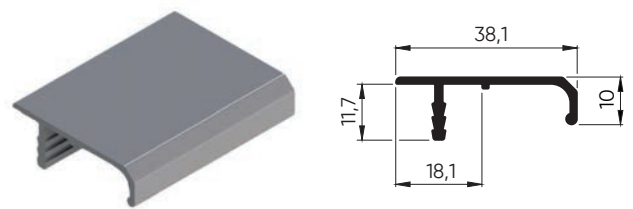

### DES-2167

Puxador de Encaixe com Espiga | MDF 18 mm  
0,244 Kg/m

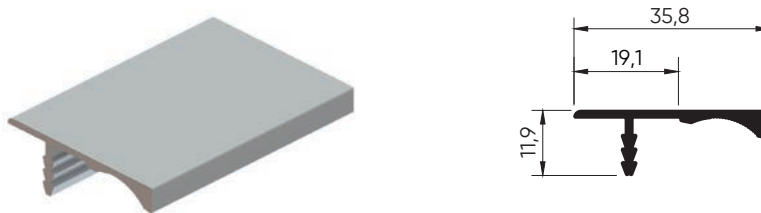

Perfil Puxador  
Cód.: DES-2167

### DES-009

Puxador de Encaixe | MDF 18 mm  
0,336 Kg/m

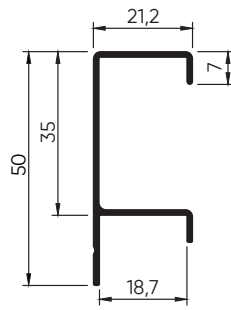

### DES-270

Puxador de Encaixe | MDF 15 mm  
0,315 Kg/m

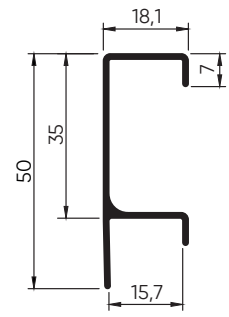

### DES-264

Puxador de Encaixe | MDF 18 mm  
0,367 Kg/m

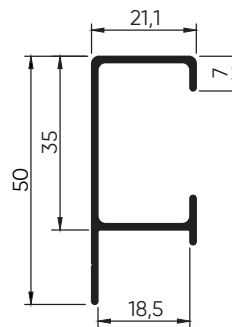

### DES-960

Puxador de Encaixe | MDF 18 mm  
0,319 Kg/m

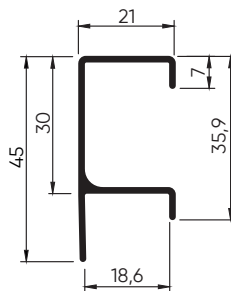

### DES-339

Puxador de Encaixe | MDF 15 mm  
0,284 Kg/m

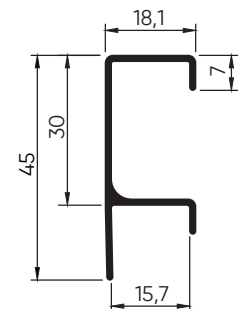

### DES-202

Puxador de Encaixe | MDF 18 mm  
0,517 Kg/m

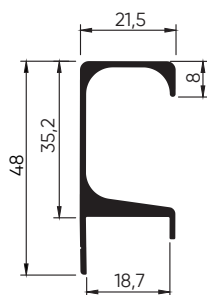

### DES-214

Puxador de Encaixe | MDF 15 mm  
0,498 Kg/m

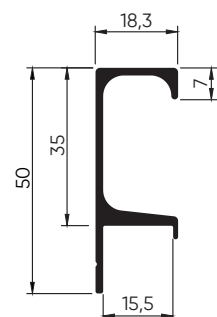

A ALUMICONTE reserva-se o direito de fazer modificações em qualquer informação escrita neste catálogo sem aviso prévio. Os desenhos aqui contidos possuem medidas teóricas de massa e tolerâncias dimensionais de acordo com a ABNT NBR-8116, podendo haver variações dessas informações no produto final.

### DES-212

Puxador de Encaixe | MDF 18 mm  
0,419 Kg/m

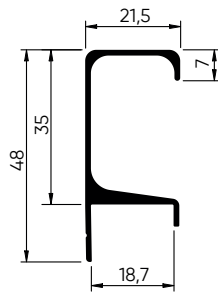

### DES-213

Puxador de Encaixe | MDF 15 mm  
0,392 Kg/m

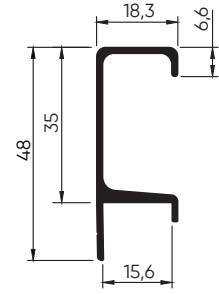

### DES-275

Puxador de Encaixe | MDF 18 mm  
0,434 Kg/m  
Ponteira disponível

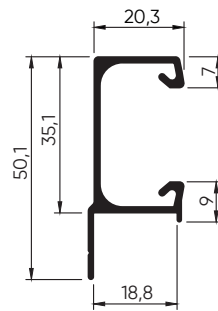

### DES-284

Puxador de Encaixe | MDF 15 mm  
0,349 Kg/m  
Ponteira disponível

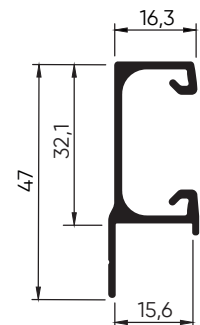

### DES-1400

Puxador de Encaixe | MDF 18 mm  
0,386 Kg/m  
Ponteira disponível

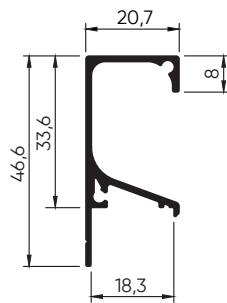

### DES-1401

Puxador de Encaixe | MDF 15 mm  
0,340 Kg/m  
Ponteira disponível

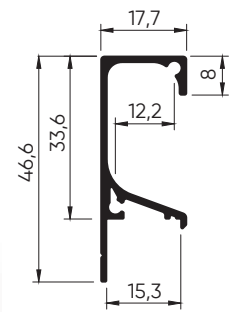
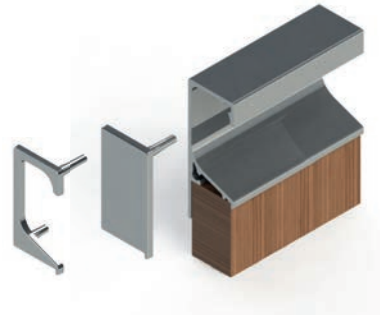

### DES-197

Puxador de Encaixe | MDF 18 mm  
0,387 Kg/m  
Ponteira disponível

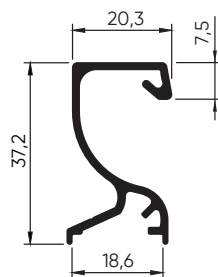
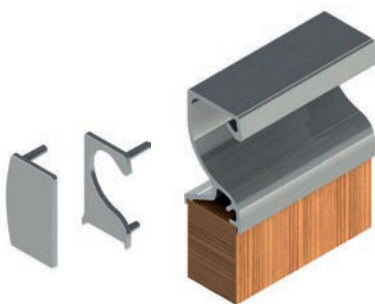

### DES-312

Puxador de Encaixe | MDF 15 mm  
0,315 Kg/m  
Ponteira disponível

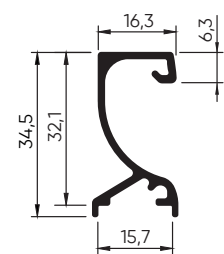
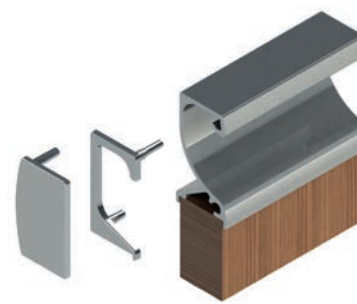

A ALUMICONTE reserva-se o direito de fazer modificações em qualquer informação escrita neste catálogo sem aviso prévio. Os desenhos aqui contidos possuem medidas teóricas de massa e tolerâncias dimensionais de acordo com a ABNT NBR-8116, podendo haver variações dessas informações no produto final.

### DES-620

Puxador de Encaixe | MDF 18 mm

0,461 Kg/m

Ponteira disponível

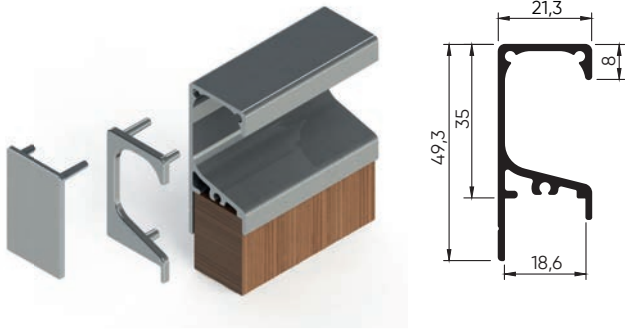

### DES-621

Puxador de Encaixe | MDF 15 mm

0,420 Kg/m

Ponteira disponível

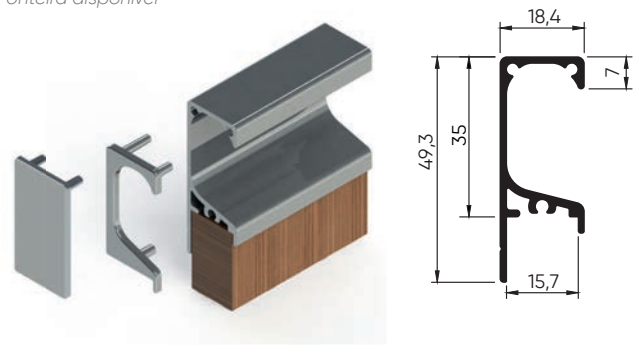

### DES-074

Puxador de Encaixe | MDF 18 mm

0,446 Kg/m

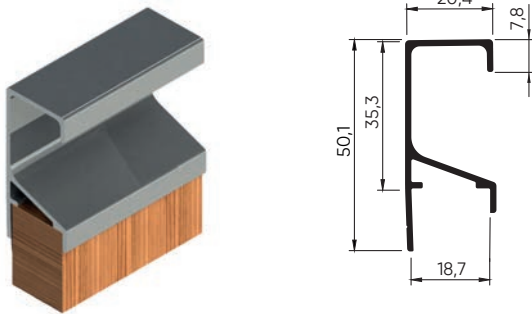

### DES-089

Puxador de Encaixe | MDF 18 mm

0,461 Kg/m

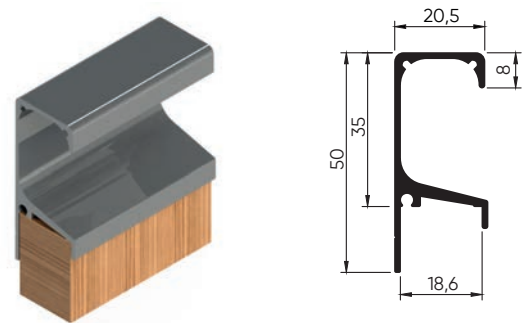

### DES-385

Puxador de Encaixe | MDF 18 mm

0,469 Kg/m

Ponteira disponível

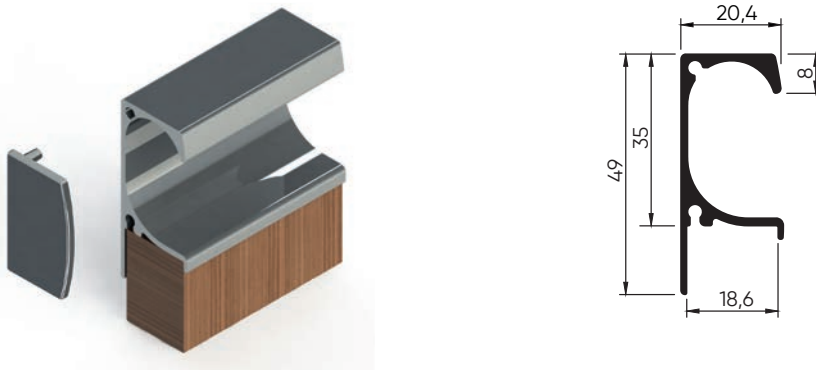

### DES-201

Puxador de Encaixe | MDF 18 mm

0,456 Kg/m

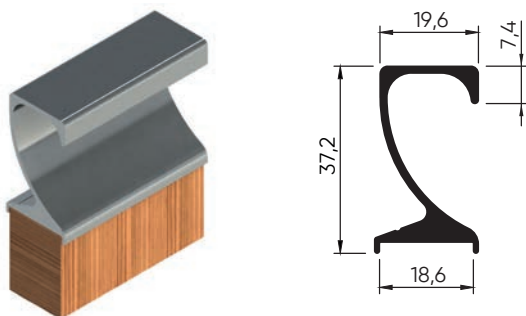

### DES-949

Puxador de Encaixe | MDF 18 mm

0,469 Kg/m

Ponteira disponível

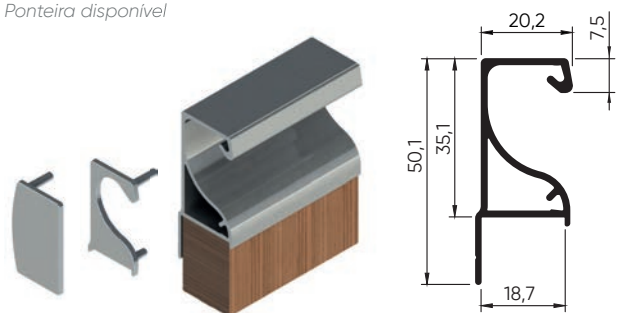

A ALUMICONTE reserva-se o direito de fazer modificações em qualquer informação escrita neste catálogo sem aviso prévio. Os desenhos aqui contidos possuem medidas teóricas de massa e tolerâncias dimensionais de acordo com a ABNT NBR-8116, podendo haver variações dessas informações no produto final.

### DES-142

Puxador de Encaixe com Espiga | MDF 18 mm  
0,441 Kg/m

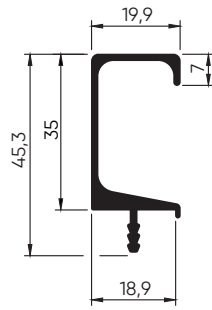
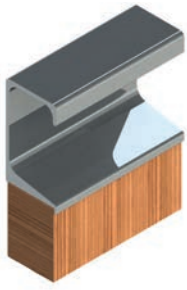

### DES-238

Puxador de Encaixe com Espiga | MDF 15 mm  
0,377 Kg/m

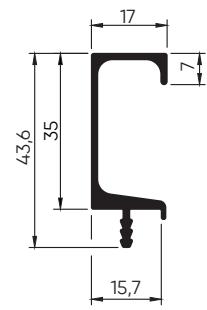

### DES-314

Puxador de Encaixe com Espiga | MDF 18 mm  
0,457 Kg/m  
Ponteira disponível

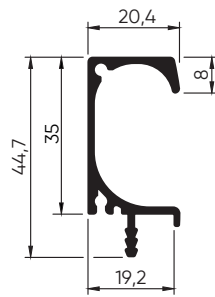

### DES-611

Puxador de Encaixe com Espiga | MDF 18 mm  
0,437 Kg/m  
Ponteira disponível

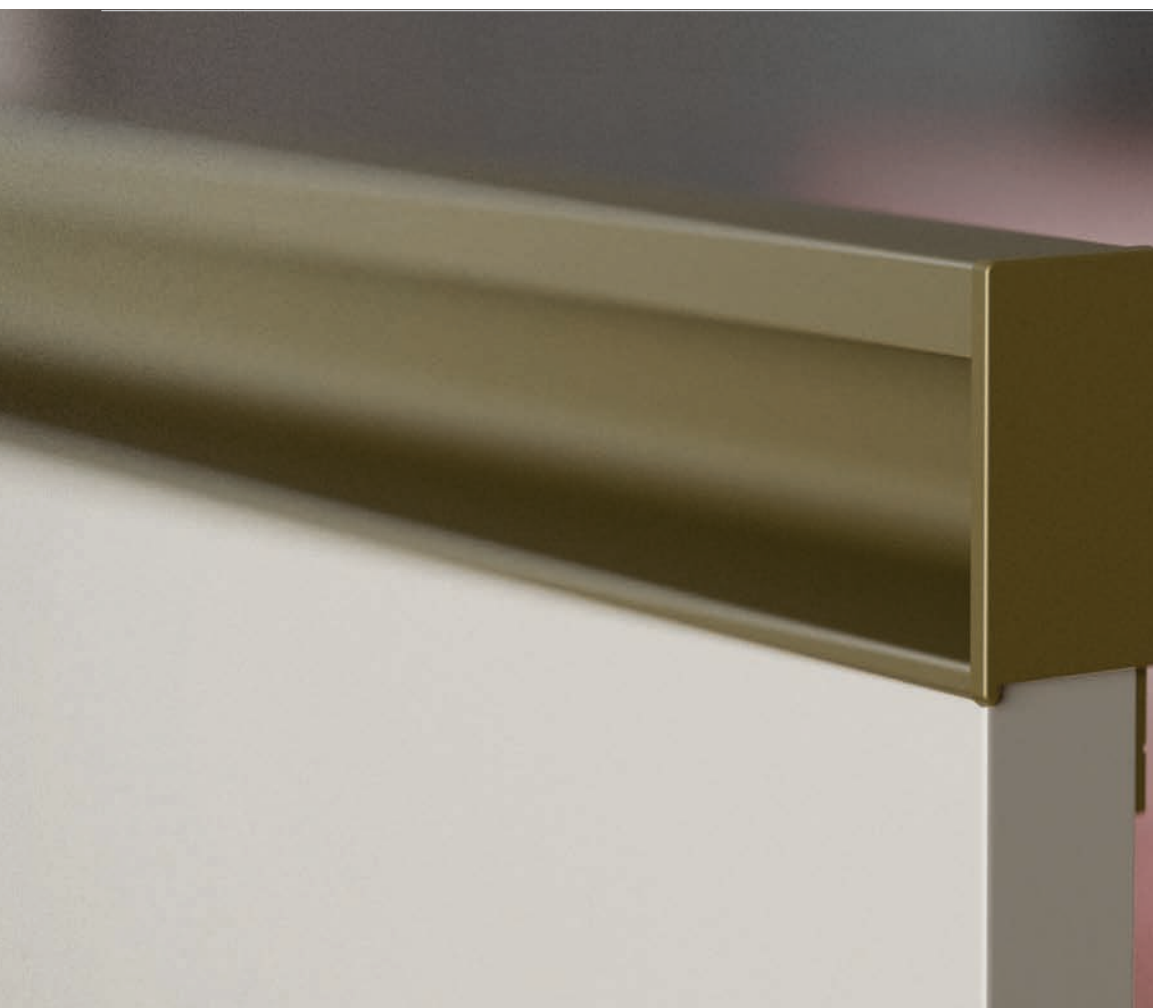
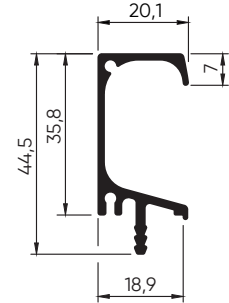

Perfil Puxador  
Cód.: DES-1401

A ALUMICONTE reserva-se o direito de fazer modificações em qualquer informação contida neste catálogo sem aviso prévio. Os desenhos aqui contidos possuem medidas técnicas que podem sofrer alterações dimensionais de acordo com o ABNT NBR-8116, podendo haver variações dessas informações no produto final.

### DES-102

Puxador de Encaixe | MDF 18 mm

0,423 Kg/m

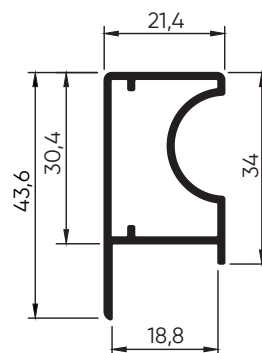
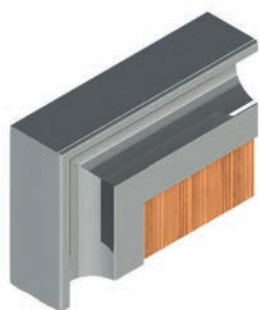

### DES-162

Puxador de Encaixe | MDF 15 mm

0,437 Kg/m

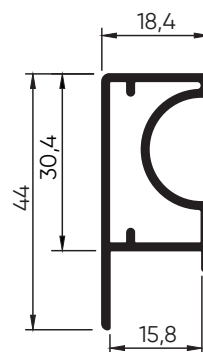

### DES-222

Puxador de Encaixe | MDF 15 mm

0,384 Kg/m

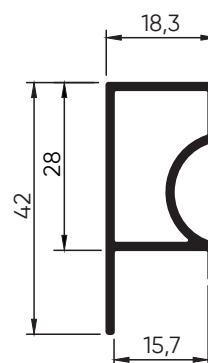
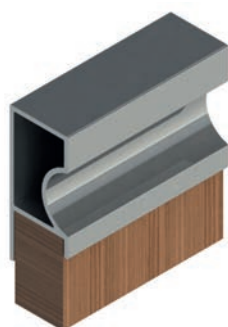

### DES-307

Puxador de Encaixe | MDF 15 mm

0,396 Kg/m

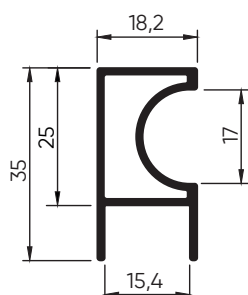

### DES-291

Puxador de Encaixe | MDF 18 mm

0,445 Kg/m

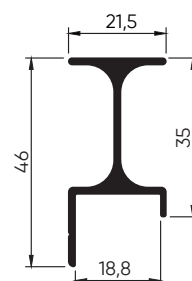
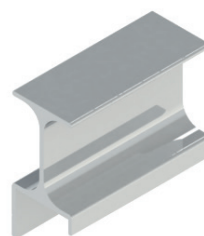

A ALUMICONTE reserva-se o direito de fazer modificações em qualquer informação escrita neste catálogo sem aviso prévio. Os desenhos aqui contidos possuem medidas teóricas de massa e tolerâncias dimensionais de acordo com a ABNT NBR-8116, podendo haver variações dessas informações no produto final.

### DES-063

Puxador de Embutir  
0,440 Kg/m

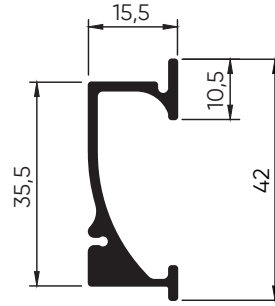

### DES-064

Puxador de Embutir  
0,366 Kg/m

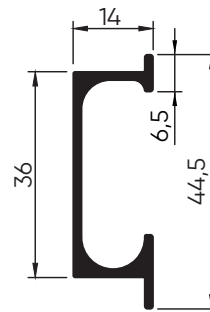
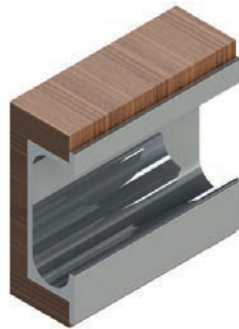

### DES-046

Puxador de Embutir  
0,112 Kg/m

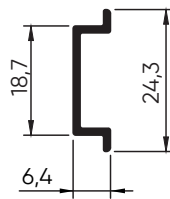

### DES-347

Puxador de Embutir  
0,354 Kg/m

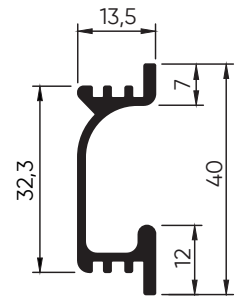
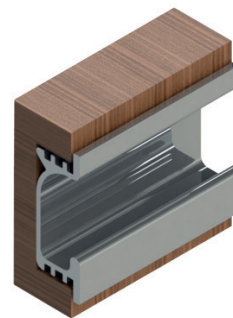

### DES-881

Puxador de Embutir  
0,383 Kg/m  
*Ponteira disponível*

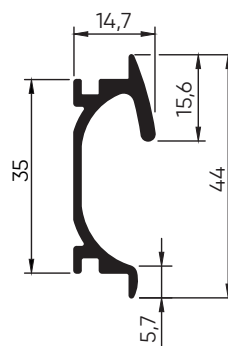

PONTEIRA  
COMPATÍVEL



A ALUMICONTE reserva-se o direito de fazer modificações em qualquer informação escrita neste catálogo sem aviso prévio. Os desenhos aqui contidos possuem medidas teóricas de massa e tolerâncias dimensionais de acordo com a ABNT NBR-8116, podendo haver variações dessas informações no produto final.

## QUADRO DE VIDRO

Projetados para estruturar o quadro e acomodar a folha de vidro com precisão, esses perfis se adaptam a diferentes posições, garantindo flexibilidade e excelência em cada projeto.



**DES-912**  
Requadro do Vidro  
0,552 Kg/m

Compatível • MONTAGEM  
DES-1614 | DES-1226 | DES-226

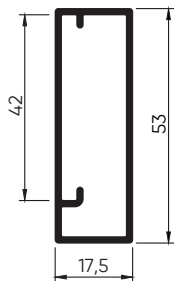

**DES-1226**  
Quadro de Vidro  
0,615 Kg/m

Compatível • MONTAGEM  
DES-1225 | DES-1227 | DES-1228

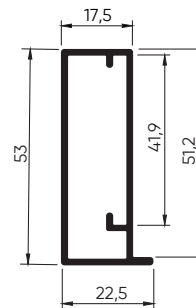

**DES-1225**  
Quadro de Vidro com Puxador  
0,676 Kg/m

Compatível • MONTAGEM  
DES-1226 | DES-1227

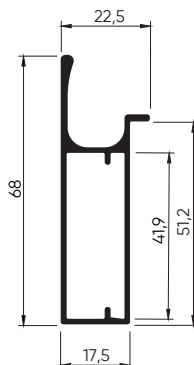

PONTEIRA COMPATÍVEL



**DES-1227**  
Quadro de Vidro com Puxador  
0,633 Kg/m

Compatível • MONTAGEM  
DES-1225 | DES-1226 | DES-1228

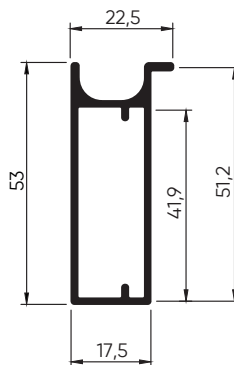
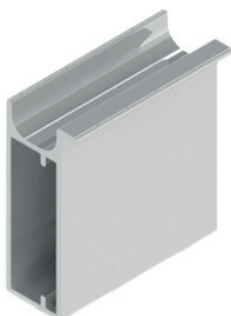

PONTEIRA COMPATÍVEL



**DES-1228**  
Quadro de Vidro com Puxador  
0,862 Kg/m

Compatível • MONTAGEM  
DES-1226 | DES-1227

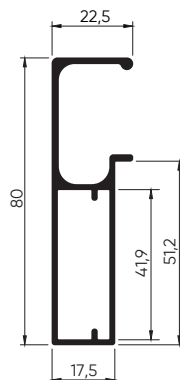

PONTEIRA COMPATÍVEL



A ALUMICONTE reserva-se o direito de fazer modificações em qualquer informação escrita neste catálogo sem aviso prévio. Os desenhos aqui contidos possuem medidas teóricas de massa e tolerâncias dimensionais de acordo com a ABNT NBR-8116, podendo haver variações dessas informações no produto final.

Perfis Quadro de Vidro e Quadro de Vidro com Puxador

Cód.: DES-1226 e DES-1225



## DES-912

Requadro do Vidro

0,552 Kg/m

Compatível • MONTAGEM  
DES-1614 | DES-1226 | DES-226

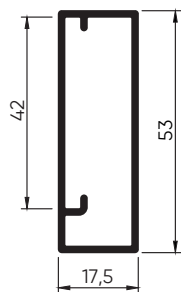

## DES-225

Quadro Pele de Vidro com Puxador

0,698 Kg/m

Compatível • MONTAGEM  
DES-226 | DES-227

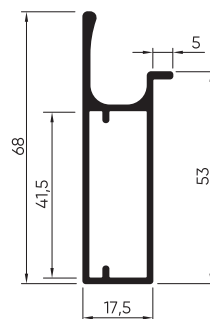
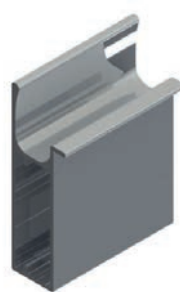

PONTEIRA COMPATÍVEL



## DES-226

Requadro do Vidro

0,591 Kg/m

Compatível • MONTAGEM  
DES-1614 | DES-1226 | DES-226

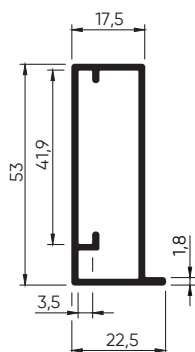

## DES-227

Quadro Pele de Vidro com Puxador

0,608 Kg/m

Compatível • MONTAGEM  
DES-226 | DES-227

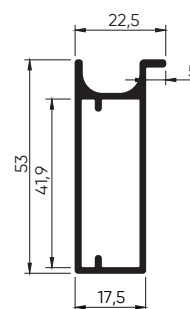

PONTEIRA COMPATÍVEL



## DES-1271

Quadro de Vidro com Puxador

0,862 Kg/m

Compatível • MONTAGEM  
DES-1614 | DES-1226 | DES-226

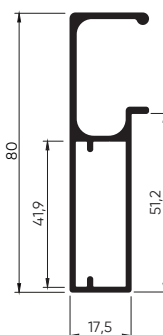

PONTEIRA COMPATÍVEL



A ALUMICONTE reserva-se o direito de fazer modificações em qualquer informação escrita neste catálogo sem aviso prévio. Os desenhos aqui contidos possuem medidas teóricas de massa e tolerâncias dimensionais de acordo com a ABNT NBR-8116, podendo haver variações dessas informações no produto final.

### DES-1042

Quadro de Vidro  
0,562 Kg/m

Compatível • MONTAGEM  
DES-1043

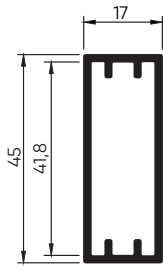

ESQUADRETA  
ESQ-001



### DES-1043

Requadro de Vidro com Puxador  
0,939 Kg/m

Compatível • MONTAGEM  
DES-1042

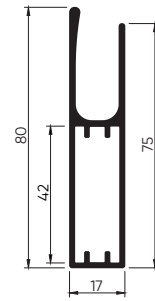

ESQUADRETA  
ESQ-001



### DES-1093

Requadro de Vidro  
0,536 Kg/m

Compatível • MONTAGEM  
DES-1094

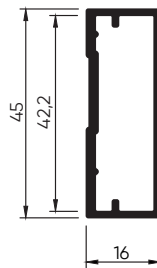

ESQUADRETA  
ESQ-001



### DES-1094

Requadro Pele de Vidro com Puxador  
0,879 Kg/m

Compatível • MONTAGEM  
DES-1093

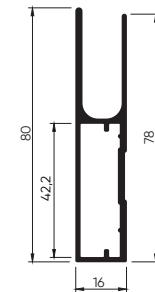

ESQUADRETA  
ESQ-001



Perfil Requadro Pele  
de Vidro com Puxador  
Cód.: DES-1094

A ALUMICONTE reserva-se o direito de fazer modificações em qualquer informação escrita neste catálogo sem aviso prévio. Os desenhos aqui contidos possuem medidas teóricas de massa e tolerâncias dimensionais de acordo com a ABNT NBR 3100, podendo haver variações dessas informações no produto final.

### DES-198

Quadro de Vidro - 4,5mm  
0,462 Kg/m

Compatível • MONTAGEM  
DES-877 | DES-950 | DES-282  
DES-204 | DES-897 | DES-856  
Compatível • PUXADOR  
DES-112 | DES-203 | DES-239  
DES-1252 | DES-1299 | DES-1324

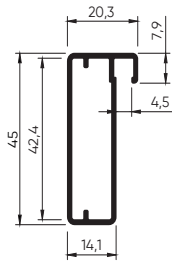

### DES-204

Quadro de Vidro com Puxador  
0,855 Kg/m

Compatível • MONTAGEM  
DES-198

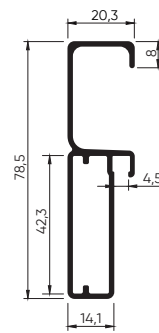
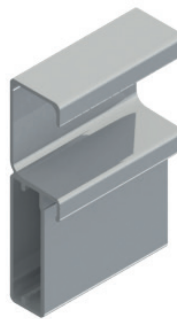

### DES-877

Quadro de Vidro com Puxador  
0,524 Kg/m

Compatível • MONTAGEM  
DES-198

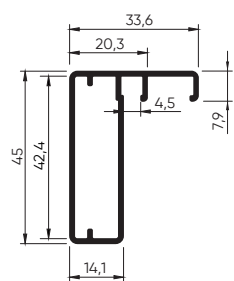
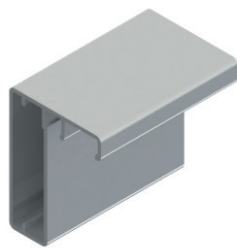

### DES-950

Quadro de Vidro com Puxador  
0,801 Kg/m  
Ponteira disponível

Compatível • MONTAGEM  
DES-198

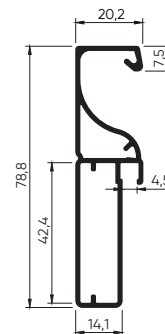

### DES-282

Quadro de Vidro com Puxador  
0,800 Kg/m  
Ponteira disponível

Compatível • MONTAGEM  
DES-198

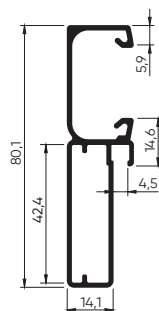
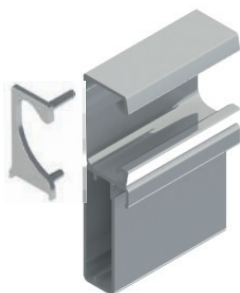

### DES-897

Quadro de Vidro com Puxador  
0,681 Kg/m

Compatível • MONTAGEM  
DES-198

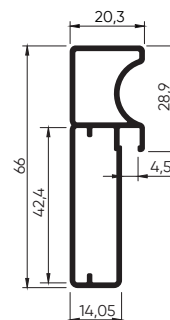
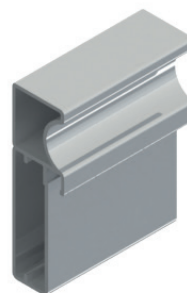

### DES-730

Quadro de Vidro com Puxador  
0,831 Kg/m  
Ponteira disponível

Compatível • MONTAGEM  
DES-198

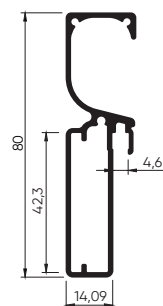
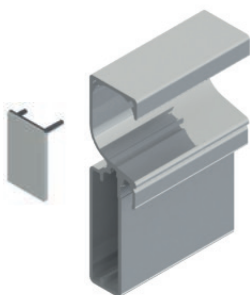

### DES-856

Travessa Quadro de Vidro  
0,196 Kg/m

Compatível • MONTAGEM  
DES-198 | DES-311

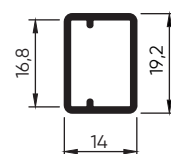

**DES-311**  
Quadro de Vidro  
0,454 Kg/m

Compatível • MONTAGEM  
DES-370 | DES-856

Compatível • PUXADOR  
DES-203 | DES-1299 | DES-1324 | DES-2185  
DES-296 | DES-395 | DES-1319

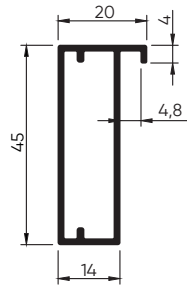

**DES-370**  
Quadro de Vidro com Puxador  
0,701 Kg/m

Compatível • MONTAGEM  
DES-1311

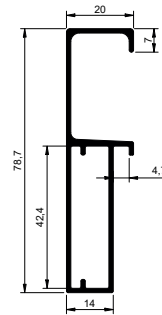

**DES-1402**  
Quadro de Vidro  
0,497 Kg/m

Compatível • MONTAGEM  
DES-1403 | DES-1016

Compatível • PUXADOR  
DES-239 | DES-112 | DES-2185  
DES-296 | DES-395 | DES-1319

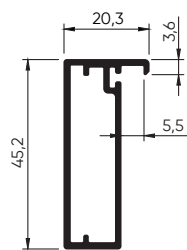

Vidro 4mm

**DES-1016**  
Travessa Quadro de Vidro  
0,232 Kg/m

Compatível • MONTAGEM  
DES-1403

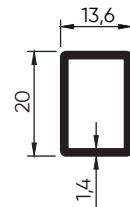

**DES-1403**  
Quadro Pele de Vidro com Puxador  
0,772 Kg/m  
Ponteira disponível

Compatível • MONTAGEM  
DES-1402

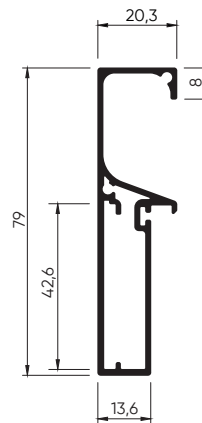
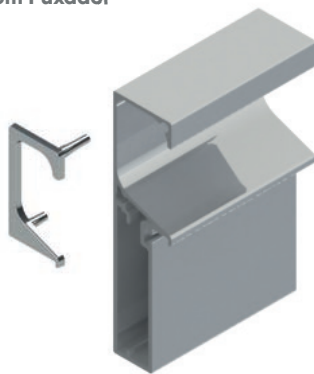

Vidro 4mm

**DES-1264**  
Quadro de Vidro  
0,395 Kg/m

Compatível • MONTAGEM  
DES-1268

Compatível • PUXADOR  
DES-239 | DES-112 | DES-2185  
DES-296 | DES-395 | DES-1319

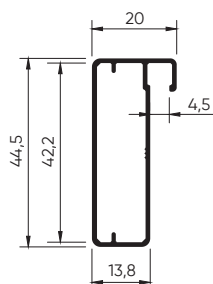

Vidro 4mm

**DES-1268**  
Quadro de Vidro com Puxador  
0,754 Kg/m

Compatível • MONTAGEM  
DES-1264

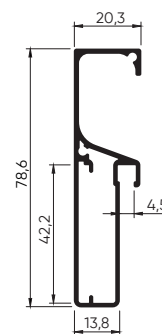

Vidro 4mm

A ALUMICONTE reserva-se o direito de fazer modificações em qualquer informação escrita neste catálogo sem aviso prévio. Os desenhos aqui contidos possuem medidas teóricas de massa e tolerâncias dimensionais de acordo com a ABNT NBR-8116, podendo haver variações dessas informações no produto final.

### DES-691

Quadro de Vidro  
0,502 Kg/m

Compatível • MONTAGEM  
DES-1419 | DES-692

Compatível • PUXADOR  
DES-239 | DES-112 | DES-2185  
DES-296 | DES-395 | DES-1319

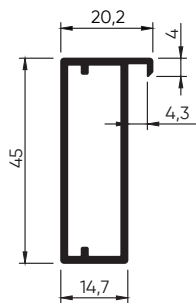

### DES-1419

Quadro de Vidro com Puxador  
0,809 Kg/m  
Ponteira disponível

Compatível • MONTAGEM  
DES-691

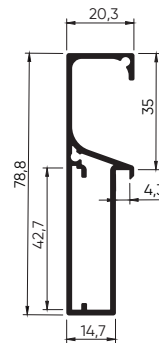

### DES-692

Quadro de Vidro  
0,619 Kg/m

Compatível • MONTAGEM  
DES-691

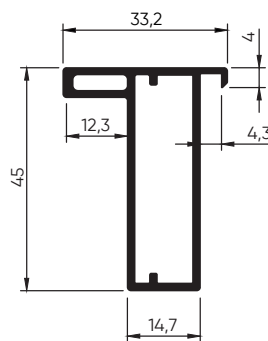

### DES-1789

Quadro de Vidro Porta Reforçado  
1,066 Kg/m

Compatível • MONTAGEM  
DES-2192

Compatível • PUXADOR  
DES-2193

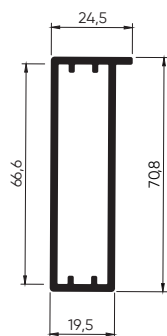
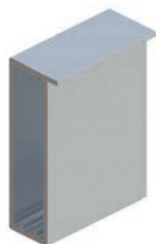

### DES-2192

Quadro de Vidro com Puxador  
1,175 Kg/m

Compatível • MONTAGEM  
DES-1789

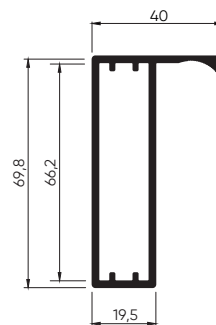

### DES-2193

Puxador 25  
0,409 Kg/m

Compatível • MONTAGEM  
DES-1789

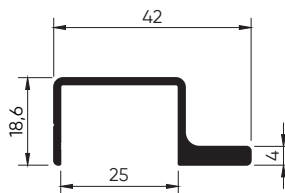
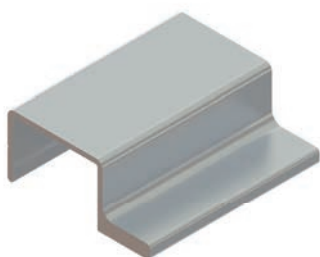

### DES-1073

Quadro de Vidro  
0,481 Kg/m

Compatível • MONTAGEM  
DES-1074 | DES-1075  
DES-2349 | DES-1697

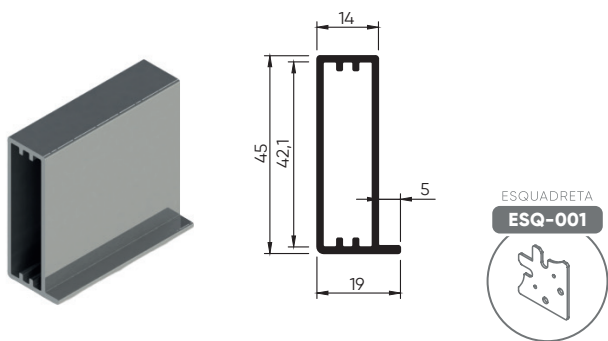

### DES-1074

Quadro de Vidro com Puxador  
0,628 Kg/m

Compatível • MONTAGEM  
DES-1073 | DES-1075

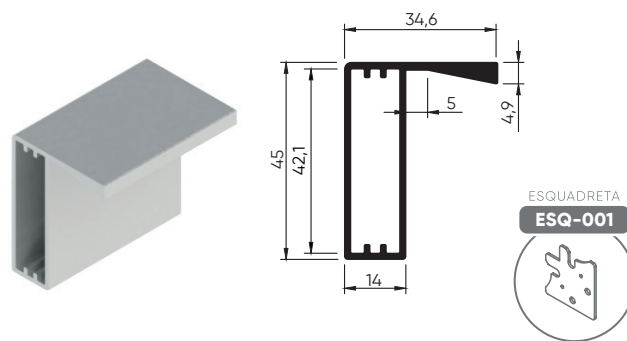

### DES-1075

Travessa Intermediária  
0,469 Kg/m

Compatível • MONTAGEM  
DES-1074 | DES-1073  
DES-2349 | DES-1697

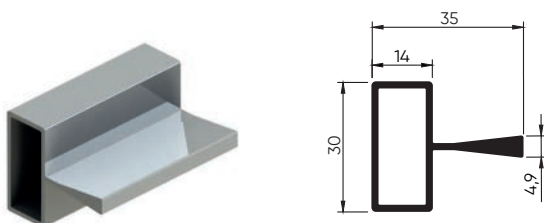

### DES-2349

Quadro de vidro com puxador  
0,601 Kg/m

Compatível • MONTAGEM  
DES-1073 | DES-1075

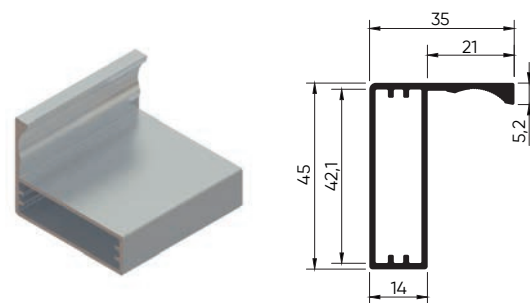

### DES-1697

Quadro de Vidro com Puxador  
0,599 Kg/m

Compatível • MONTAGEM  
DES-1073 | DES-1075

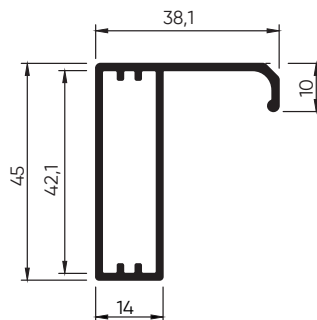

### DES-233

Quadro de Vidro  
0,479 Kg/m

Compatível • PUXADOR  
DES-232 | DES-043 | DES-112  
DES-842 | DES-1278 | DES-1324

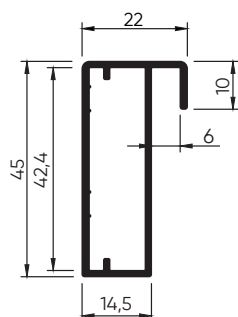

### DES-232

Puxador Encaixe Interno 11mm  
0,151 Kg/m

Compatível • MONTAGEM  
DES-233

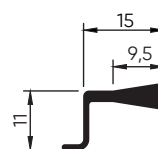

A ALUMICONTE reserva-se o direito de fazer modificações em qualquer informação escrita neste catálogo sem aviso prévio. Os desenhos aqui contidos possuem medidas teóricas de massa e tolerâncias dimensionais de acordo com a ABNT NBR-8116, podendo haver variações dessas informações no produto final.

**DES-1407**

Quadro Pele de Vidro  
0,285 Kg/m

Compatível • MONTAGEM  
DES-1408

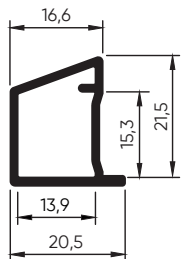

**DES-1408**

Quadro de Vidro com Puxador  
0,704 Kg/m

Compatível • MONTAGEM  
DES-1407

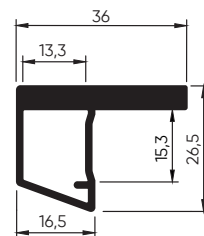

**DES-1490**

Quadro de Vidro  
0,546 Kg/m

Compatível • MONTAGEM  
DES-1489

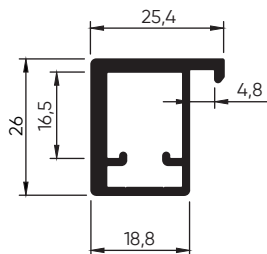
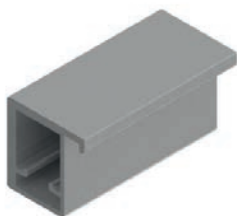

**DES-1489**

Quadro de Vidro com Puxador  
0,684 Kg/m

Compatível • MONTAGEM  
DES-1490

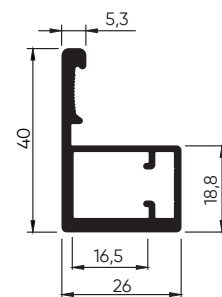

**DES-1492**

Quadro Pele de Vidro  
0,524 Kg/m

Compatível • MONTAGEM  
DES-1491

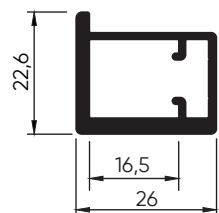

**DES-1491**

Quadro de Vidro com Puxador  
0,644 Kg/m

Compatível • MONTAGEM  
DES-1492

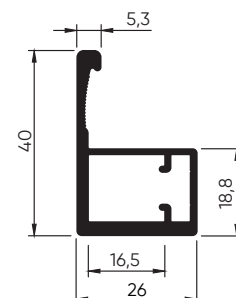

**DES-2351**

Quadro de Vidro  
0,551 Kg/m

Compatível • MONTAGEM  
DES-2350

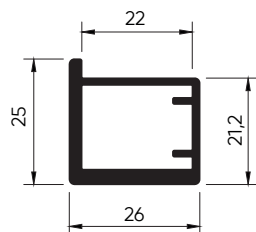
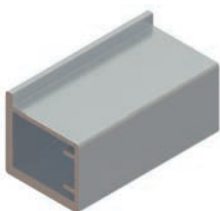

**DES-2350**

Quadro de Vidro com Puxador  
0,686 Kg/m

Compatível • MONTAGEM  
DES-2351

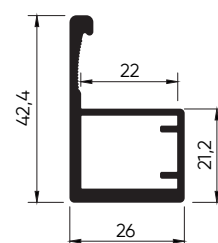
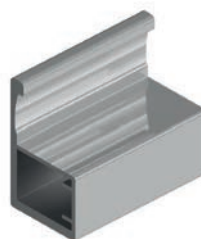

A ALUMICONTE reserva-se o direito de fazer modificações em qualquer informação escrita neste catálogo sem aviso prévio. Os desenhos aqui contidos possuem medidas teóricas de massa e tolerâncias dimensionais de acordo com a ABNT NBR-8116, podendo haver variações dessas informações no produto final.

### DES-313

Quadro de Vidro com Puxador  
0,574 Kg/m

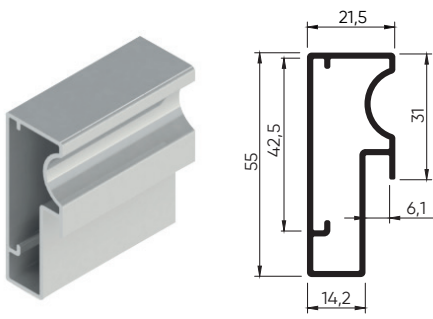

### DES-320

Quadro de Vidro com Puxador  
0,566 Kg/m

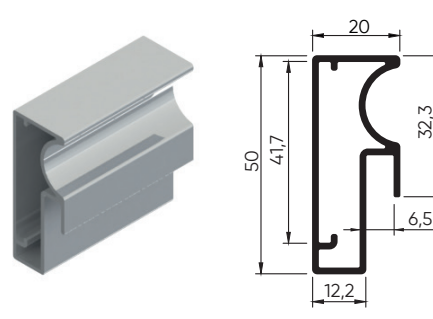

### DES-012

Quadro de Vidro com Puxador  
0,558 Kg/m

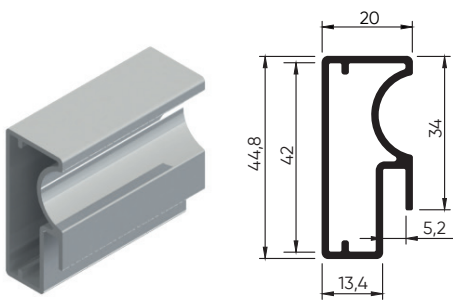

### DES-1265

Quadro de Vidro com Puxador  
0,505 Kg/m

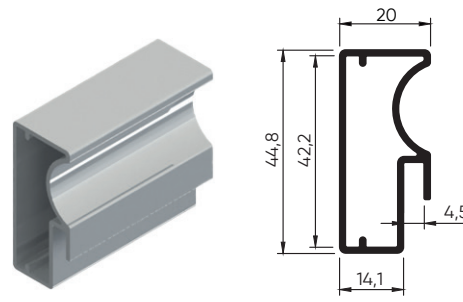

### DES-011

Quadro de Vidro com Puxador  
0,668 Kg/m

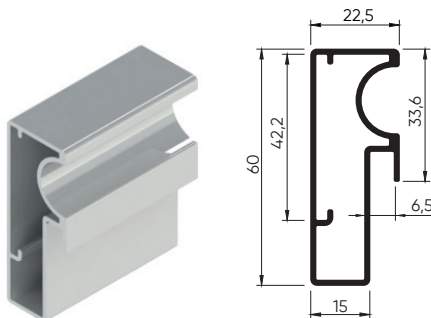

### DES-1012

Quadro de Vidro com Puxador  
0,486 Kg/m

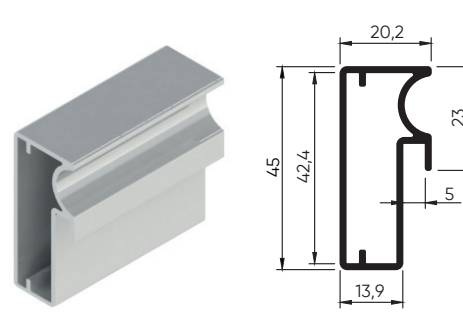

### DES-026

Quadro de Vidro com Puxador  
0,453 Kg/m

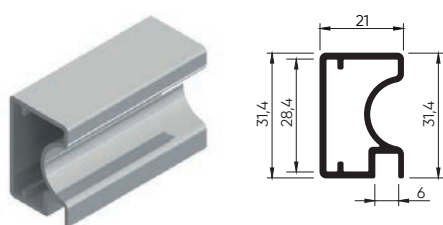

### DES-187

Quadro de Vidro com Puxador  
0,635 Kg/m

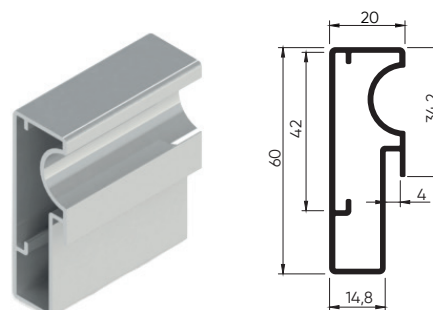

A ALUMICONTE reserva-se o direito de fazer modificações em qualquer informação escrita neste catálogo sem aviso prévio. Os desenhos aqui contidos possuem medidas teóricas de massa e tolerâncias dimensionais de acordo com a ABNT NBR-8116, podendo haver variações dessas informações no produto final.

**DES-078**

Quadro de Vidro com Puxador  
0,520 Kg/m

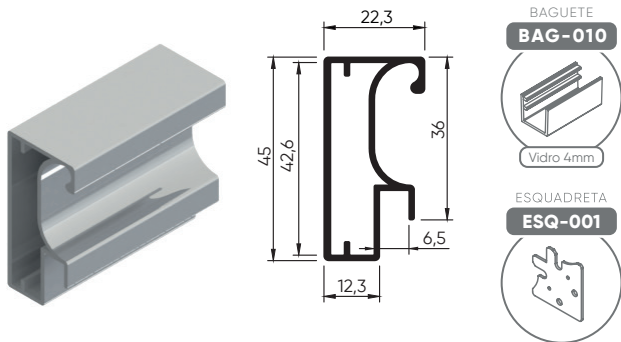

**DES-279**

Quadro de Vidro com Puxador  
0,523 Kg/m

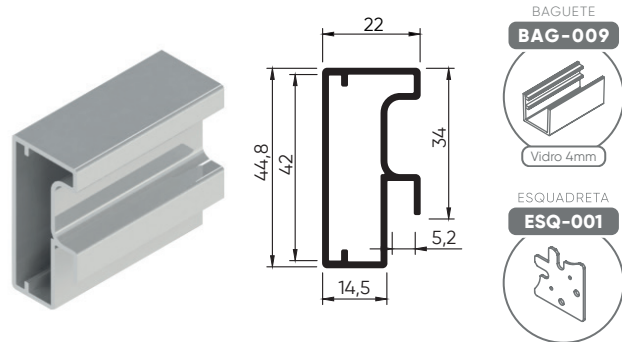

**DES-951**

Quadro Pele de Vidro  
0,721 Kg/m

Compatível • MONTAGEM  
DES-952

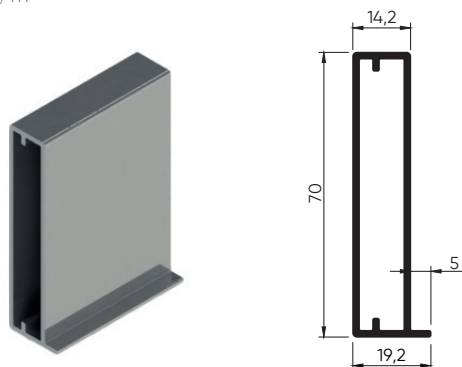

**DES-952**

Travessa Quadro de Vidro  
0,317 Kg/m

Compatível • MONTAGEM  
DES-951

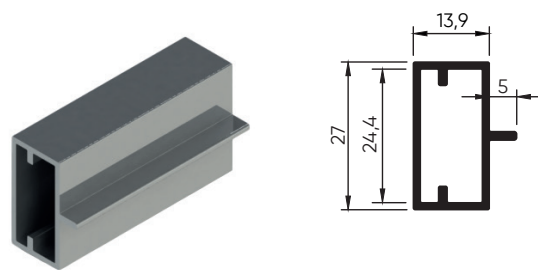

**DES-247**

Travessa Quadro de Vidro  
0,262 Kg/m

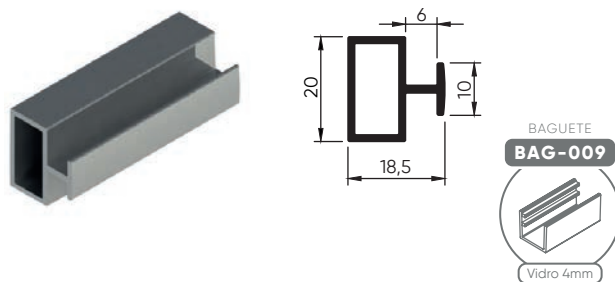

**DES-077**

Travessa Quadro de Vidro  
0,160 Kg/m

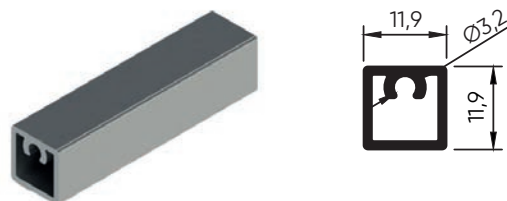

**DES-014**

Quadro de Vidro  
0,459 Kg/m

Compatível • MONTAGEM  
DES-856

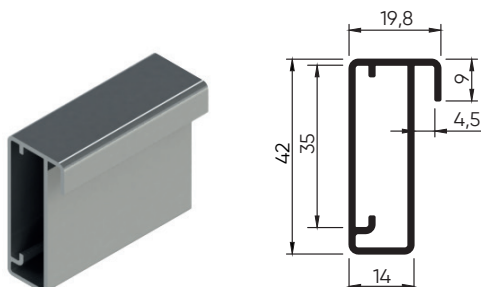

**DES-856**

Travessa Quadro de Vidro  
0,196 Kg/m

Compatível • MONTAGEM  
DES-014

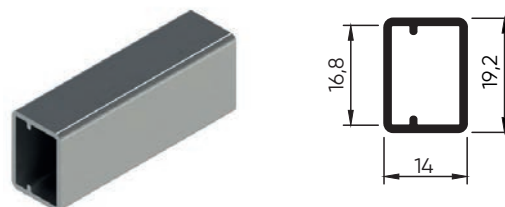

A ALUMICONTE reserva-se o direito de fazer modificações em qualquer informação escrita neste catálogo sem aviso prévio. Os desenhos aqui contidos possuem medidas teóricas de massa e tolerâncias dimensionais de acordo com a ABNT NBR-8116, podendo haver variações dessas informações no produto final.

**DES-1250**

Quadro de Vidro  
0,443 Kg/m

Compatível • PUXADOR  
DES-519

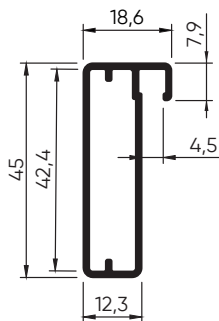

**DES-929**

Quadro de Vidro  
0,488 Kg/m

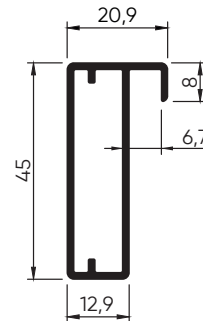

**DES-001**

Quadro de Vidro  
0,466 Kg/m

Compatível • PUXADOR  
DES-112 | DES-842

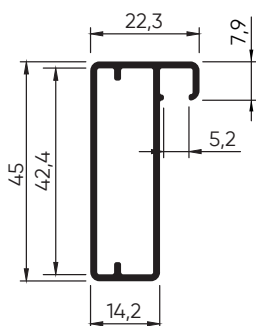

**DES-007**

Quadro de Vidro  
0,508 Kg/m

Compatível • PUXADOR  
DES-239

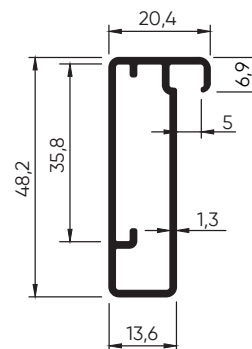

**DES-721**

Quadro de Vidro  
0,559 Kg/m

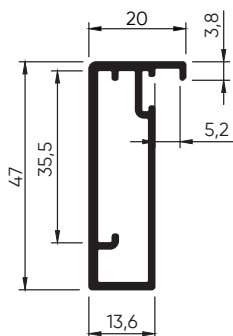

**DES-875**

Quadro de Vidro  
0,443 Kg/m

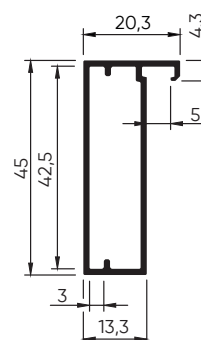

**DES-084**

Quadro de Vidro  
0,407 Kg/m

Compatível • PUXADOR  
DES-519

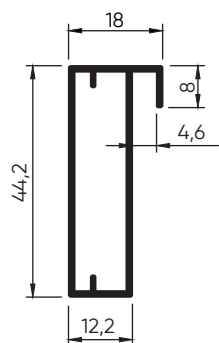
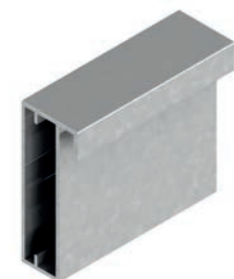

**DES-318**

Quadro de Vidro  
0,427 Kg/m

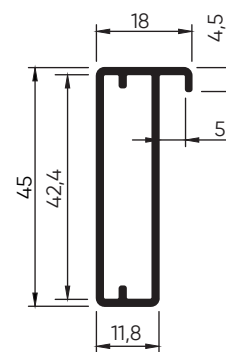

A ALUMICONTE reserva-se o direito de fazer modificações em qualquer informação escrita neste catálogo sem aviso prévio. Os desenhos aqui contidos possuem medidas teóricas de massa e tolerâncias dimensionais de acordo com a ABNT NBR-8116, podendo haver variações dessas informações no produto final.

**DES-062**

Quadro de Vidro  
0,455 Kg/m

Compatível • PUXADOR  
DES-1299 | DES-1324

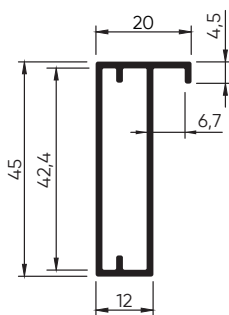

**DES-530**

Quadro de Vidro  
0,433 Kg/m

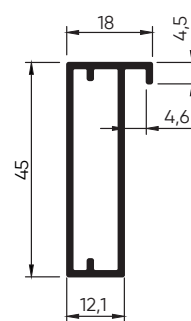

**DES-550**

Quadro de Vidro  
0,438 Kg/m

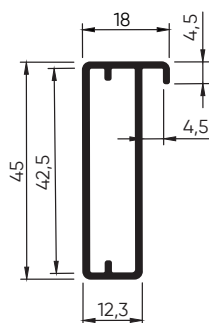

**DES-133**

Quadro de Vidro  
0,508 Kg/m

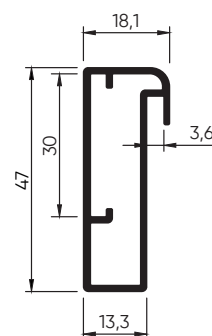

**DES-002**

Quadro de Vidro  
0,798 Kg/m

Compatível • PUXADOR  
DES-112 | DES-842 | DES-1613

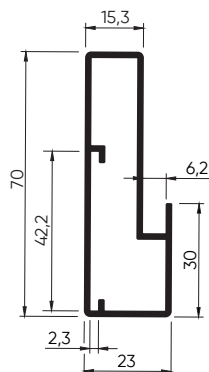

**DES-010**

Quadro de Vidro  
0,451 Kg/m

Compatível • PUXADOR  
DES-203 | DES-1299 | DES-1324

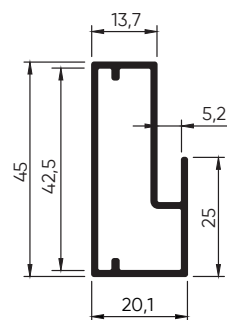

**DES-1326**

Quadro de Vidro  
0,658 Kg/m

Compatível • PUXADOR  
DES-043

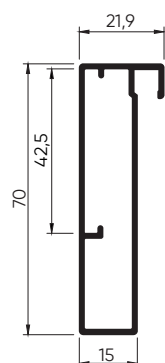

**DES-1328**

Quadro de Vidro  
0,863 Kg/m

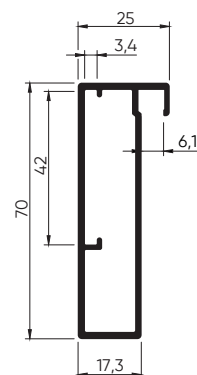

A ALUMICONTE reserva-se o direito de fazer modificações em qualquer informação escrita neste catálogo sem aviso prévio. Os desenhos aqui contidos possuem medidas teóricas de massa e tolerâncias dimensionais de acordo com o ABNT NBR-8116, podendo haver variações dessas informações no produto final.

### DES-1612

Quadro de Vidro  
0,819 Kg/m

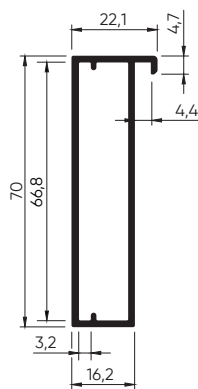

Compatível • PUXADOR  
DES-043 | DES-112 | DES-842

### DES-902

Quadro de Vidro  
0,792 Kg/m

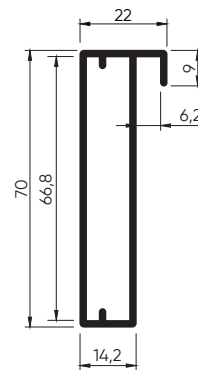

Compatível • PUXADOR  
DES-239 | DES-1299 | DES-1324

### DES-297

Quadro de Vidro  
0,671 Kg/m

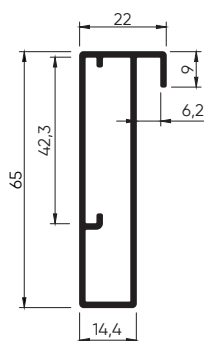

Compatível • PUXADOR  
DES-043 | DES-112 | DES-842 | DES-1278

### DES-060

Quadro de Vidro  
0,422 Kg/m

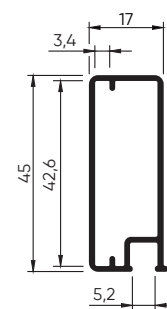

### DES-1934

Folha Encaixilhada  
0,301 Kg/m

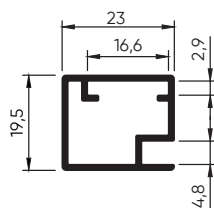
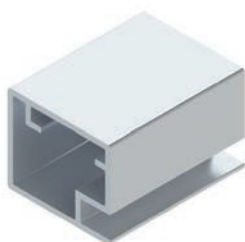

### DES-016

Quadro de Vidro  
0,469 Kg/m

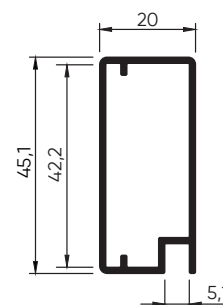

### DES-1279

Quadro Pele de Vidro  
0,472 Kg/m

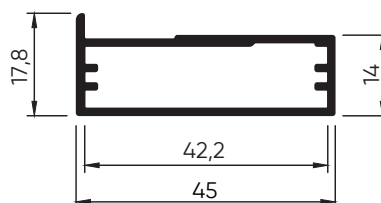
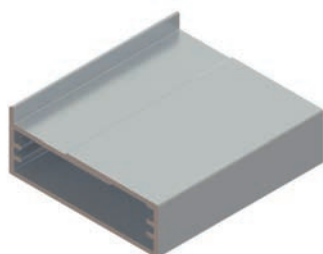

A ALUMICONTE reserva-se o direito de fazer modificações em qualquer informação escrita neste catálogo sem aviso prévio. Os desenhos aqui contidos possuem medidas teóricas de massa e tolerâncias dimensionais de acordo com a ABNT NBR-8116, podendo haver variações dessas informações no produto final.



Perfil Quadro para MDF  
Cód.: DES-2074

### DES-2074

Requadro Aplicação MDF 6mm  
0,516 Kg/m

Compatível • PUXADOR  
DES-239 | DES-1299

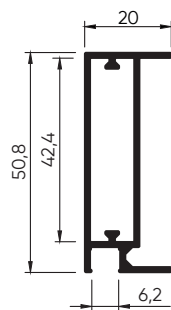

Simulação de montagem

### DES-2075

Quadro Porta Aplicação para Porcelanato  
0,488 Kg/m

Compatível • PUXADOR  
DES-043 | DES-112

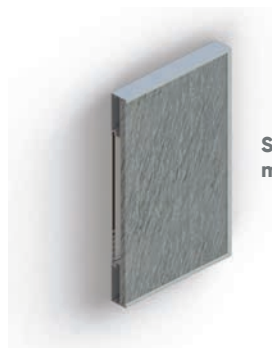
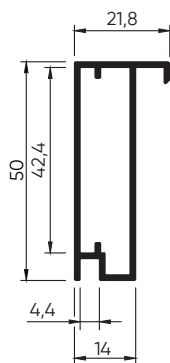

Simulação de montagem

ESQUADRETA

ESQ-001



A ALUMICONTE reserva-se o direito de alterar sem qualquer informação escrita neste catálogo sem aviso prévio. Os desenhos aqui contidos possuem medidas teóricas e não representam a realidade. Podem ocorrer variações de cor e acabamento devido a variações de materiais e processos de fabricação. Não são garantidos prazos de entrega e prazo de validade. Não são garantidos prazos de entrega e prazo de validade.

Perfil Quadro para Porcelanato  
Cód.: DES-2075



**DES-2425**

Quadro Pele de Vidro  
0,458 Kg/m

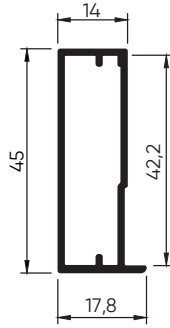
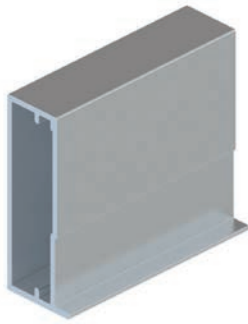

**DES-953**

Quadro Pele de Vidro  
0,459 Kg/m

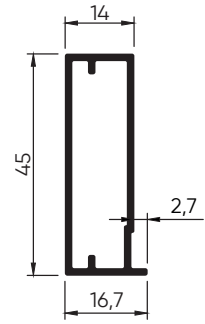
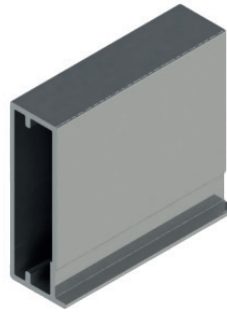

**DES-1451**

Quadro Pele de Vidro  
0,983 Kg/m

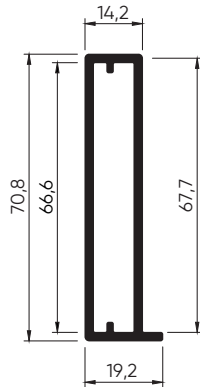

**DES-1414**

Quadro Pele de Vidro  
0,506 Kg/m

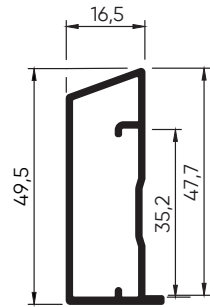

**DES-073**

Quadro Pele de Vidro  
0,491 Kg/m

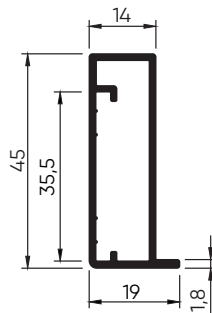

Compatível • PUXADOR  
DES-909

**DES-1321**

Quadro Pele de Vidro  
0,890 Kg/m

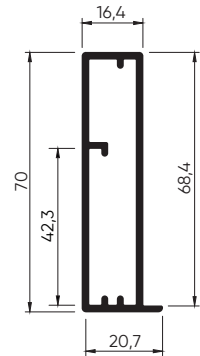

**DES-147**

Quadro Pele de Vidro  
0,382 Kg/m

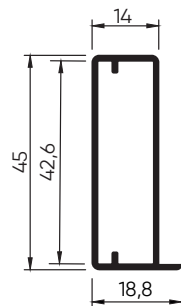
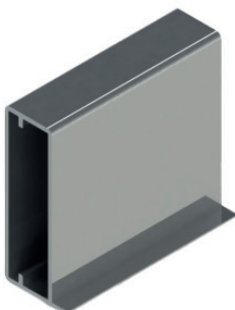

**DES-3098**

Quadro Pele de Vidro 45x18,8mm  
0,383 Kg/m

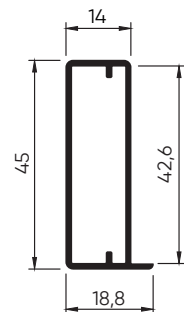

A ALUMICONTE reserva-se o direito de fazer modificações em qualquer informação escrita neste catálogo sem aviso prévio. Os desenhos aqui contidos possuem medidas teóricas de massa e tolerâncias dimensionais de acordo com a ABNT NBR-8116, podendo haver variações dessas informações no produto final.

### DES-1291

Quadro de Vidro  
0,576 Kg/m

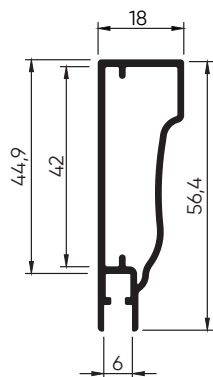

### DES-178

Quadro de Vidro  
0,376 Kg/m

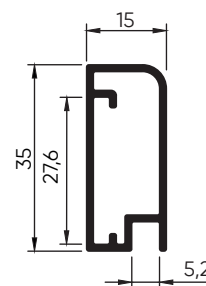

### DES-019

Quadro de Vidro  
0,421 Kg/m

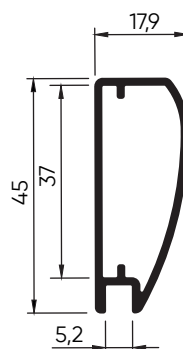

### DES-017

Quadro de Vidro  
0,495 Kg/m

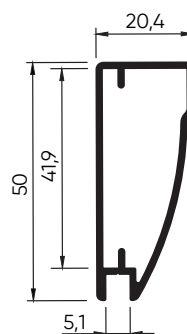

### DES-015

Quadro de Vidro  
0,372 Kg/m

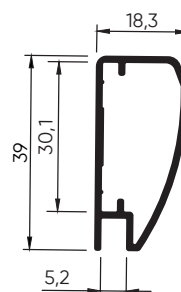
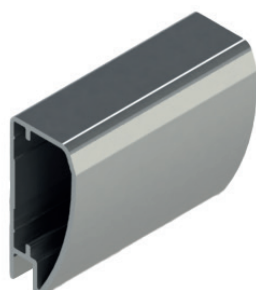

A ALUMICONTE reserva-se o direito de fazer modificações em qualquer informação escrita neste catálogo sem aviso prévio. Os desenhos aqui contidos possuem medidas teóricas de massa e tolerâncias dimensionais de acordo com a ABNT NBR-8116, podendo haver variações dessas informações no produto final.

### DES-043

Puxador de Encaixe  
0,304 Kg/m

Compatível • MONTAGEM  
DES-233 | DES-297 | DES-832  
DES-902 | DES-1326 | DES-1612

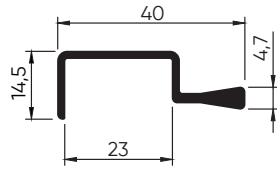
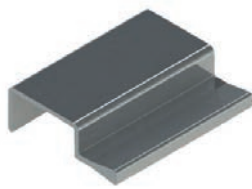

### DES-239

Puxador de Encaixe  
0,283 Kg/m

Compatível • MONTAGEM  
DES-007 | DES-008 | DES-014 | DES-198  
DES-721 | DES-875 | DES-1264

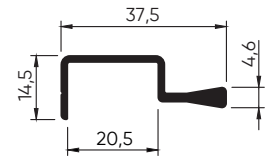
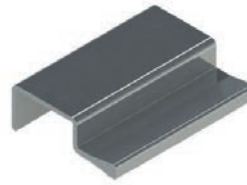

### DES-519

Puxador de Encaixe  
0,282 Kg/m

Compatível • MONTAGEM  
DES-089 | DES-300  
DES-1250 | DES-1443

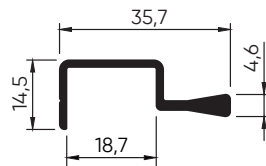
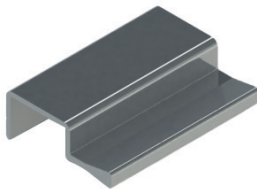

### DES-1613

Puxador de Encaixe  
0,356 Kg/m

Compatível • MONTAGEM  
DES-002

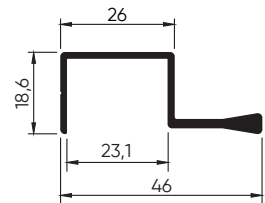
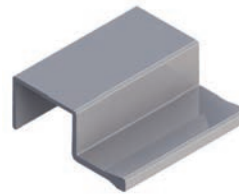

### DES-1614

Puxador de Encaixe  
0,345 Kg/m

Compatível • MONTAGEM  
DES-300 | DES-912

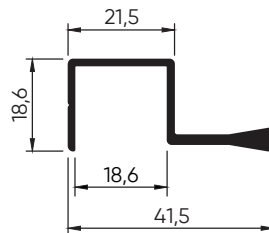
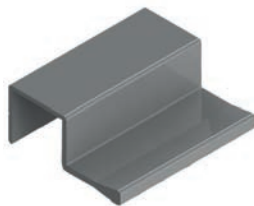

### DES-1251

Puxador de Encaixe  
0,266 Kg/m

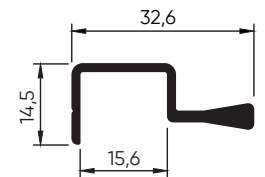

### DES-2185

Puxador Quadro 20  
0,277 Kg/m

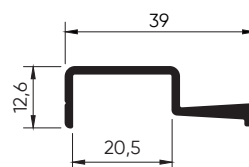
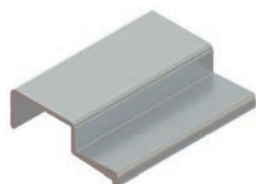

### DES-2184

Puxador de Encaixe  
0,269 Kg/m

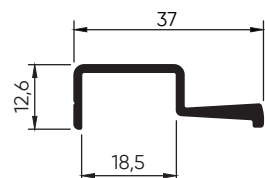
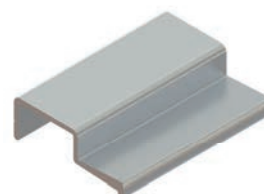

A ALUMICONTE reserva-se o direito de fazer modificações em qualquer informação escrita neste catálogo sem aviso prévio. Os desenhos aqui contidos possuem medidas teóricas de massa e tolerâncias dimensionais de acordo com a ABNT NBR-8116, podendo haver variações dessas informações no produto final.

### DES-1420

Puxador de Encaixe  
0,352 Kg/m

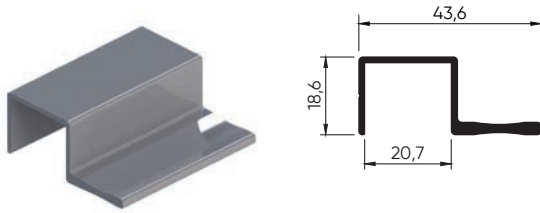

### DES-112

Puxador de Encaixe  
0,316 Kg/m

Compatível · MONTAGEM  
DES-001 | DES-002 | DES-198 | DES-233  
DES-297 | DES-902 | DES-1612

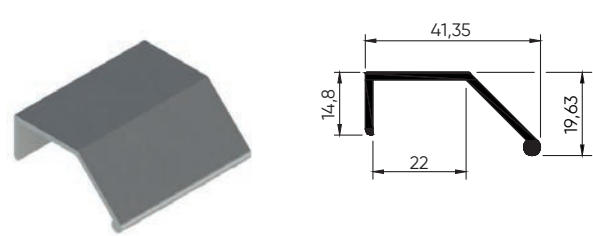

### DES-842

Puxador de Encaixe  
0,240 Kg/m

Compatível · MONTAGEM  
DES-001 | DES-002 | DES-233  
DES-297 | DES-902 | DES-1612

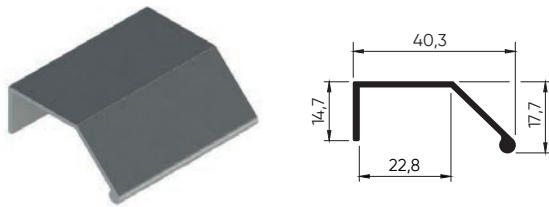

### DES-203

Puxador de Encaixe - 15mm  
0,259 Kg/m

Compatível · MONTAGEM  
DES-010 | DES-198  
DES-311 | DES-691

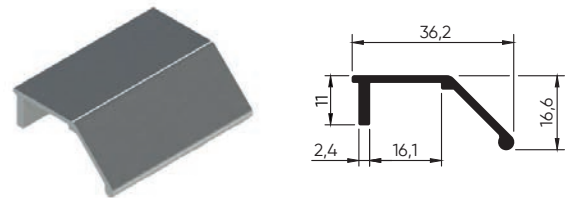

### DES-909

Puxador de Encaixe  
0,279 Kg/m

Compatível · MONTAGEM  
DES-073

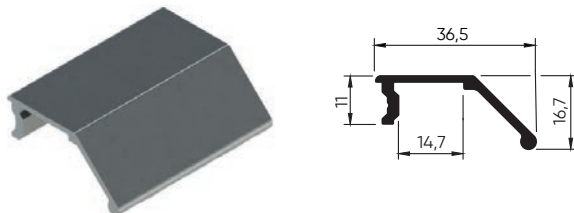

### DES-993

Puxador de Encaixe  
0,214 Kg/m

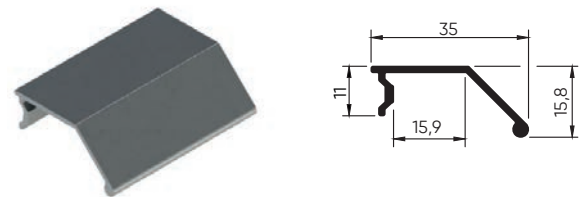

### DES-1278

Puxador de Encaixe  
0,268 Kg/m

Compatível · MONTAGEM  
DES-233 | DES-297

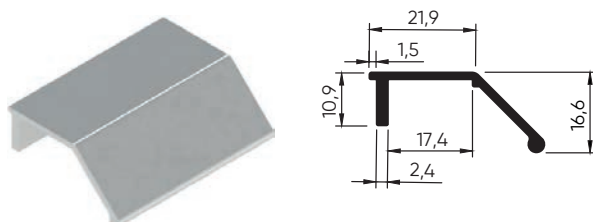

### DES-148

Puxador de Encaixe Interno  
0,245 Kg/m

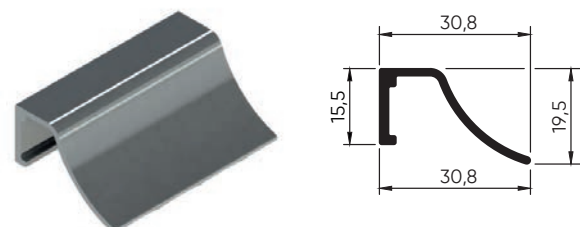

### DES-296

Puxador de Encaixe  
0,246 Kg/m

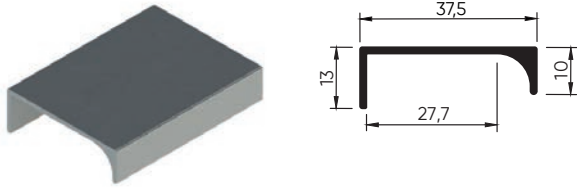

### DES-395

Puxador de Encaixe  
0,293 Kg/m

Compatível · MONTAGEM  
ARM-062 | ARM-198

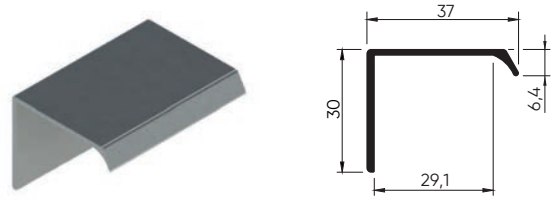

### DES-1319

Puxador de Encaixe  
0,372 Kg/m

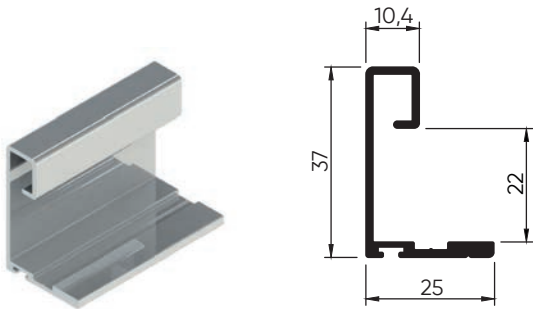

### DES-1329

Puxador de Encaixe  
0,364 Kg/m

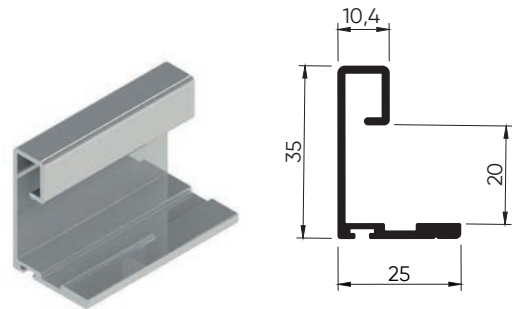

### DES-1332

Puxador de Encaixe  
0,383 Kg/m

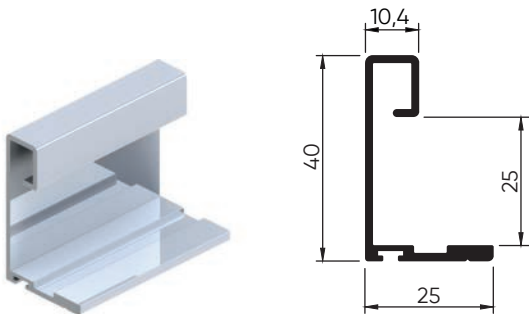

### DES-901

Puxador de Encaixe  
0,230 Kg/m

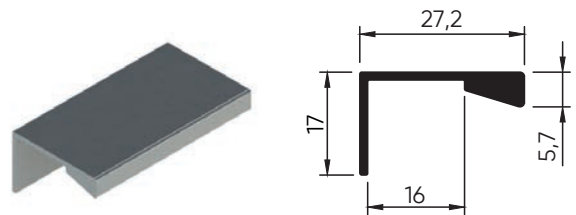

### DES-1324

Puxador de Encaixe  
0,218 Kg/m

Compatível · MONTAGEM  
DES-010 | DES-062 | DES-198 | DES-233 |  
DES-311 | DES-691 | DES-875

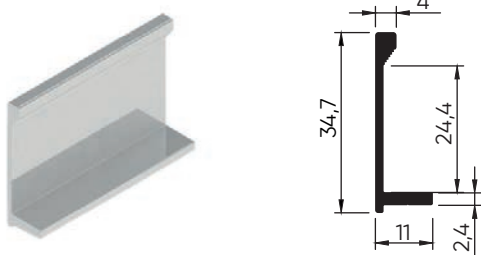

### DES-1299

Puxador de Encaixe  
0,261 Kg/m

Compatível · MONTAGEM  
DES-010 | DES-198  
DES-311 | DES-691

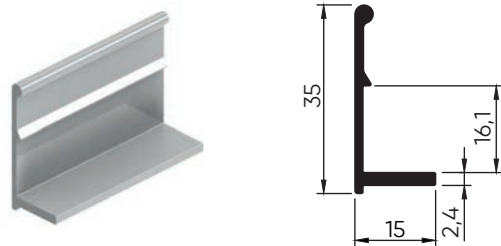

A ALUMICONTE reserva-se o direito de fazer modificações em qualquer informação escrita neste catálogo sem aviso prévio. Os desenhos aqui contidos possuem medidas teóricas de massa e tolerâncias dimensionais de acordo com a ABNT NBR-8116, podendo haver variações dessas informações no produto final.

**DES-2347**

Puxador de Encaixe  
0,170 Kg/m

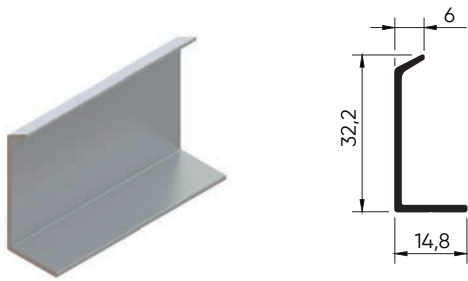

**DES-2348**

Puxador de Encaixe  
0,157 Kg/m

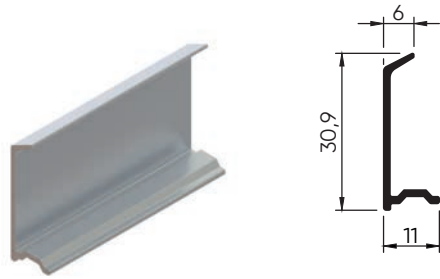

**DES-2822**

Puxador de Embutir Reto  
0,218 Kg/m

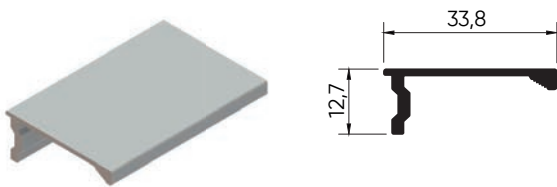

**DES-2892**

Puxador de Sobrepor Reto  
0,191 Kg/m

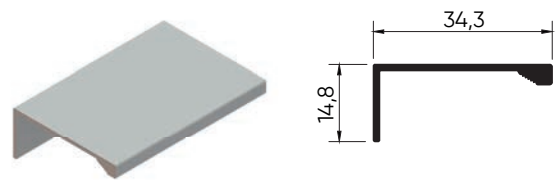

Perfil Puxador de Encaixe  
Cód.: DES-2185



A ALUMICONTE reserva-se o direito de fazer modificações em qualquer informação escrita neste catálogo sem aviso prévio. Os desenhos aqui contidos possuem medidas teóricas de massa e técnicas dimensionais de acordo com o padrão NBR-8116, podendo haver variações dessas informações no produto final.

# Alumiconte ARMO



## ALUMICONTE ARMO

Especialmente desenvolvida para entregar o melhor custo-benefício para você. Praticidade, qualidade e leveza!

### ARM-062

Quadro de Vidro  
0,335 Kg/m

Compatível • PUXADOR  
DES-239

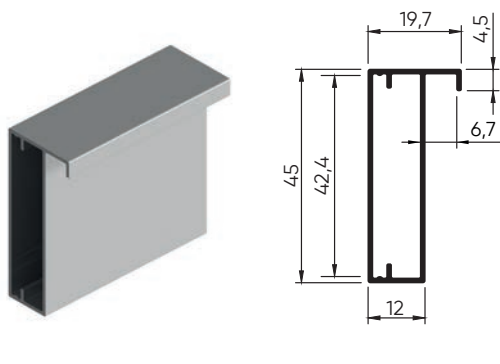

### DES-239

Puxador Encaixe  
0,283 Kg/m

Compatível • MONTAGEM  
ARM-062 | DES-007 | DES-008  
DES-014 | DES-198 | DES-721  
DES-875 | DES-1264

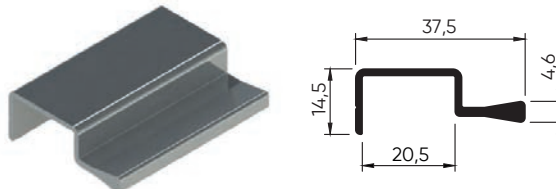

### ARM-530

Quadro de Vidro  
0,329 Kg/m

Compatível • PUXADOR  
DES-395

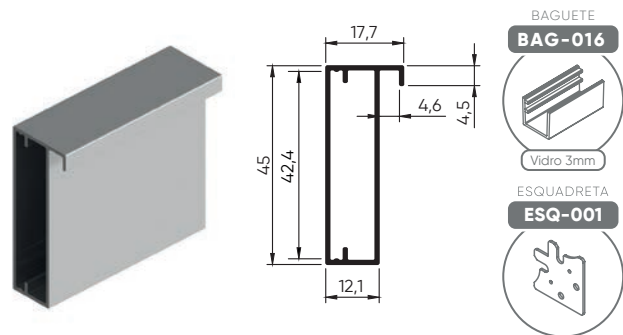

### DES-395

Puxador Encaixe  
0,293 Kg/m

Compatível • MONTAGEM  
ARM-062 | ARM-198 | ARM-530

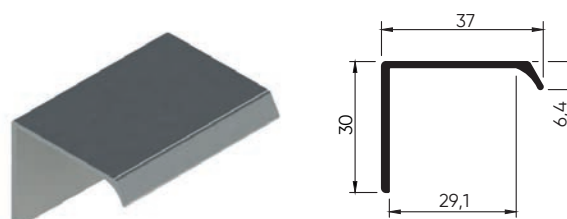

### ARM-198

Quadro de Vidro  
0,350 Kg/m

Compatível • MONTAGEM  
ARM-204

Compatível • PUXADOR  
ARM-239 | DES-395

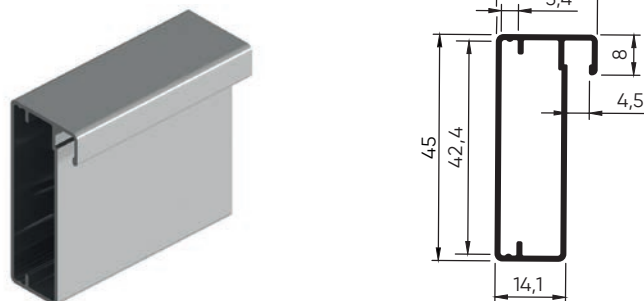

### ARM-3047

Puxador  
0,286 Kg/m

Compatível • MONTAGEM  
DES-198

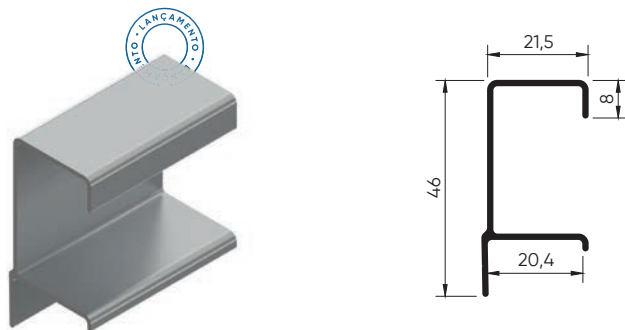

A ALUMICONTE reserva-se o direito de fazer modificações em qualquer informação escrita neste catálogo sem aviso prévio. Os desenhos aqui contidos possuem medidas teóricas de massa e tolerâncias dimensionais de acordo com a ABNT NBR-816, podendo haver variações dessas informações no produto final.

## ARMÁRIO COM ILUMINAÇÃO

Desenvolvidos para móveis de vidro com iluminação interna, esses perfis garantem montagem precisa, alta durabilidade e um visual sofisticado que transforma o ambiente.

A ALUMICONTE recebe o selo de aprovação do Instituto Brasileiro de Normas Técnicas e de Qualidade (IBRNT) em 2018, podendo haver variações de seus produtos no produto final.

### DES-1477

Montante Traseiro Vitrine  
0,952 Kg/m

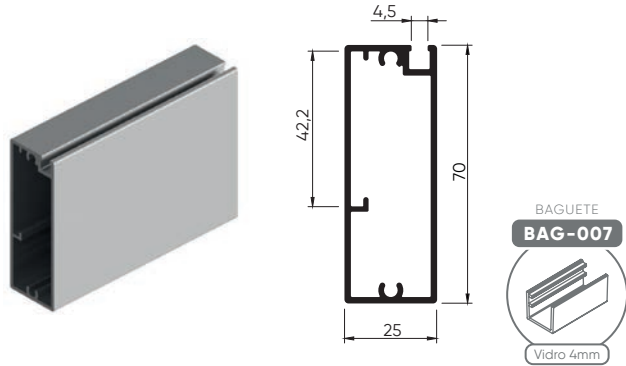

### DES-1478

Montante Frontal Vitrine  
0,989 Kg/m

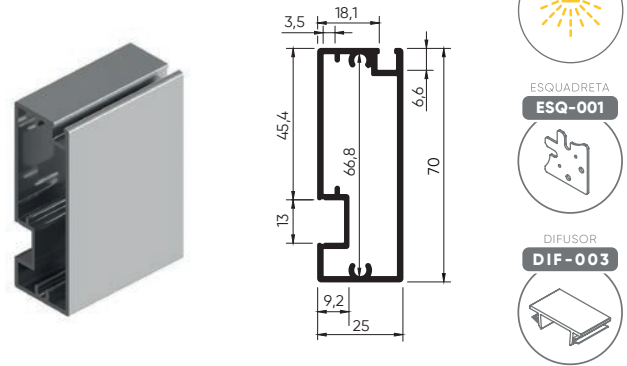

### DES-1479

Montante Central Vitrine  
0,943 Kg/m

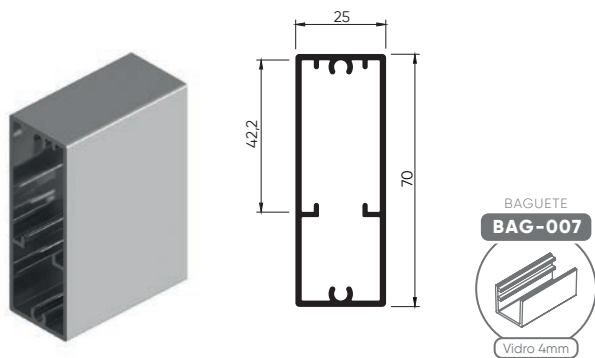

### DES-1480

Montante Central Vitrine  
0,991 Kg/m

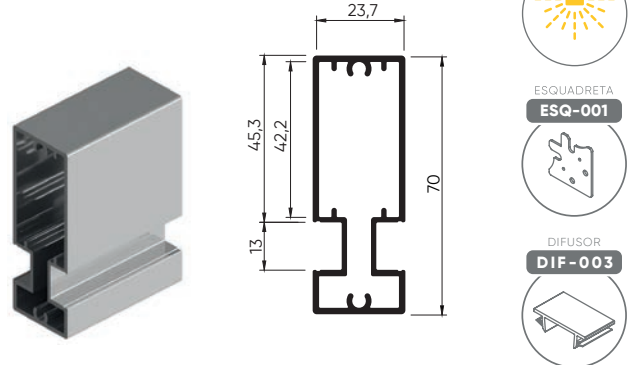

### DES-1488

Quadro Prateleira  
0,515 Kg/m

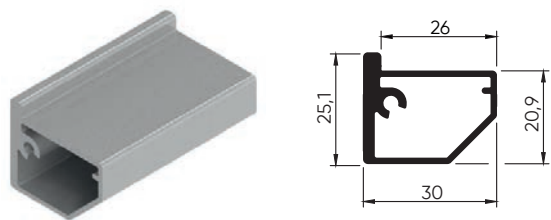

**MONTAGEM**  
Indicamos o uso da esquadreta R493 da Zimac

### DES-1487

Quadro Prateleira  
0,573 Kg/m

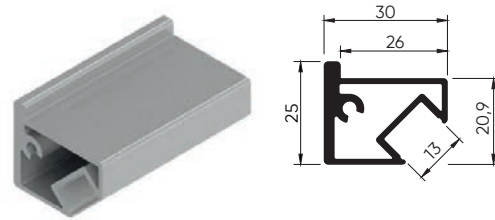

**MONTAGEM**  
Indicamos o uso da esquadreta R493 da Zimac

### DES-161

Perfil Cabideiro  
0,248 Kg/m

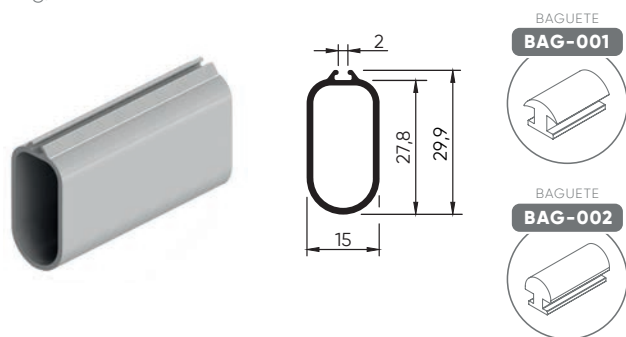

### DES-1899

Perfil Cabideiro  
0,291 Kg/m

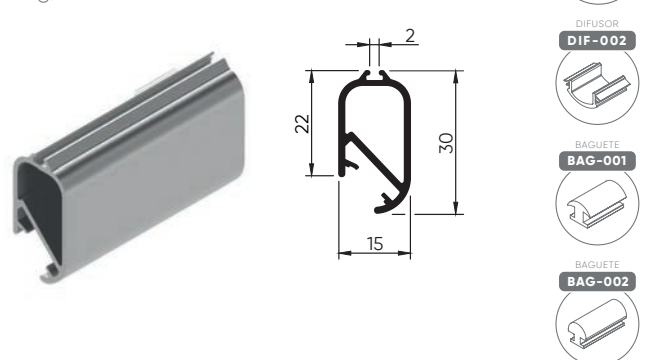

A ALUMICONTE reserva-se o direito de fazer modificações em qualquer informação escrita neste catálogo sem aviso prévio. Os desenhos aqui contidos possuem medidas teóricas de massa e tolerâncias dimensionais de acordo com a ABNT NBR-816, podendo haver variações dessas informações no produto final.

### DES-600

Travessa Superior  
0,810 Kg/m

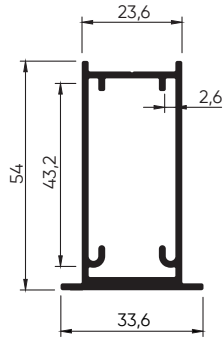
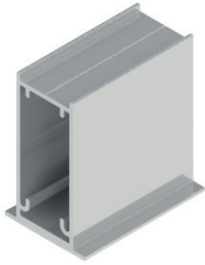

### DES-1016

Travessa Quadro de Vidro  
0,232 Kg/m

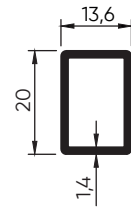

### DES-1489

Requadro de Vidro com Puxador  
0,684 Kg/m

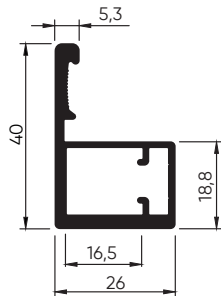

### DES-1490

Quadro de Vidro  
0,546 Kg/m

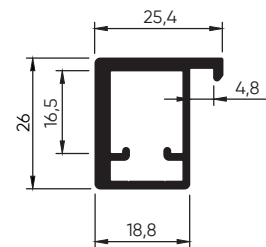

### DES-1491

Quadro de Vidro com Puxador  
0,644 Kg/m

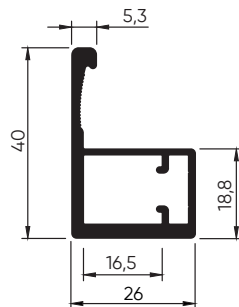

### DES-1492

Quadro Pele de Vidro  
0,524 Kg/m

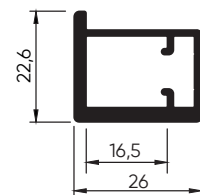

### DES-3002

Puxador Dobradiça  
23 mm

0,608 Kg/m

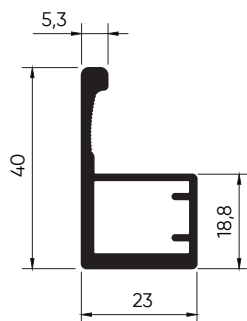

### DES-2428

Quadro de Vidro  
Dobradiça 23 mm

0,480 Kg/m

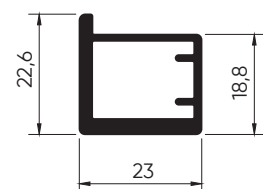

# ARMÁRIO COM ILUMINAÇÃO



A ALUMICONTE reserva-se o direito de fazer modificações sem aviso prévio. Os desenhos aqui contidos possuem medidas teóricas de massa e podem variar de acordo com a ABNT NBR-816, podendo haver variações dessas informações no produto final.





## PAINEL MOVIE

Indicado para esconder TVs e dispositivos eletrônicos, o PAINEL MOVIE contribui para um ambiente mais limpo visualmente.

A ALUMICONTE reserva-se o direito de fazer modificações em qualquer informação escrita neste catálogo sem aviso prévio. Os dados aqui contidos possuem medidas teóricas de massa e tolerâncias dimensionais de acordo com a ABNT NBR 5716, podendo haver variações dessas informações em um lote final.

## DES-1298

Quadro Painei TV

2,343 Kg/m

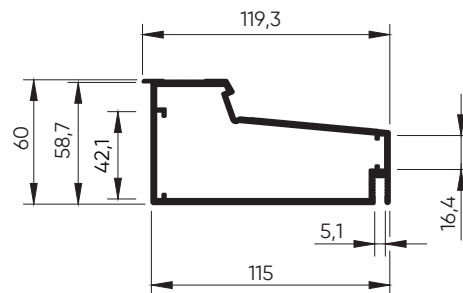
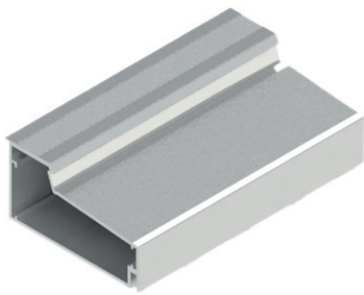

## DES-1303

Quadro Painei TV

0,946 Kg/m

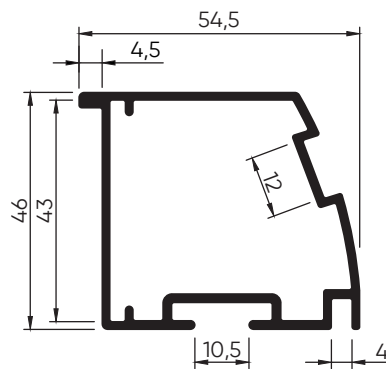

## DES-851

Tubular Suporte TV - Recebe LED

1,356 Kg/m

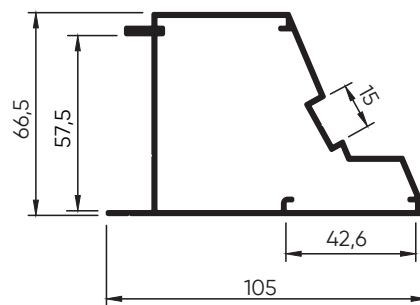

## DES-852

Tubular Suporte TV - Recebe LED

0,927 Kg/m

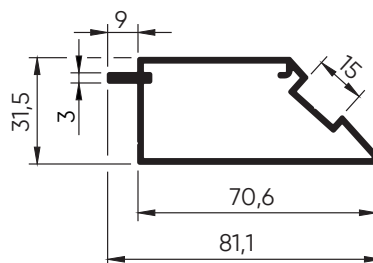

A ALUMICONTE reserva-se o direito de fazer modificações em qualquer informação escrita neste catálogo sem aviso prévio. Os desenhos aqui contidos possuem medidas teóricas de massa e tolerâncias dimensionais de acordo com a ABNT NBR-8116, podendo haver variações dessas informações no produto final.

# ALUMICONTE ÍSIS

O sistema Alumaticonte Ísis reúne perfis e componentes projetados para compor portas pivotantes com estrutura robusta, prontas para receber fechamento em:



ACM



VIDRO

Recomendação:  
vidro temperado **4mm**.

Na montagem da sua porta pivotante  
**ALUMICONTE ÍSIS**  
 você vai utilizar:

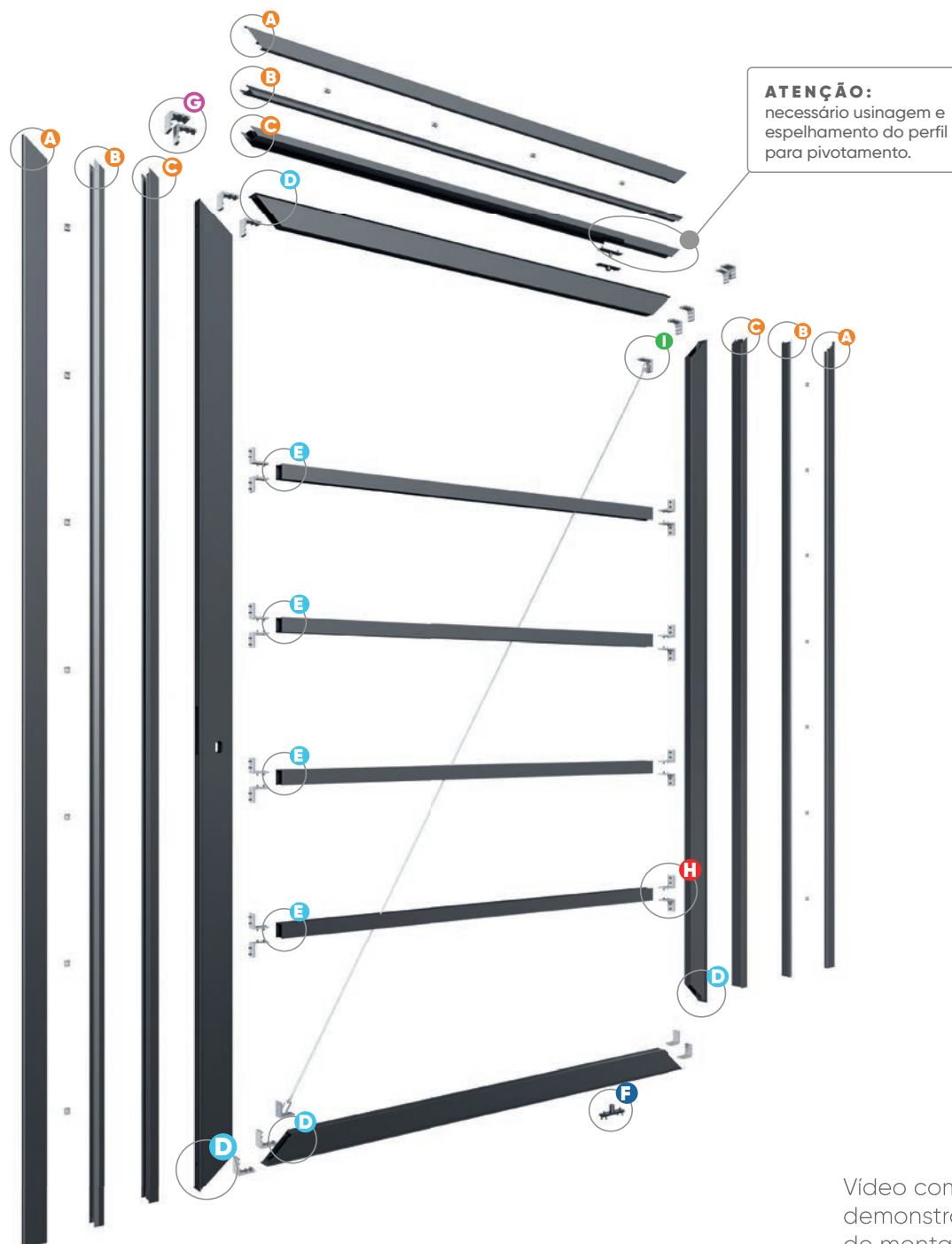

**Formas de aquisição:**

- Kit de perfis + componentes para porta de 2x3m - KPISIS01;
- Kit de componentes para ambos os tamanhos - KITISIS42 | KITISIS55;
- Perfis e componentes individualmente.

Video com demonstração de montagem



A ALUMICONTE reserva-se o direito de fazer modificações em qualquer informação escrita neste catálogo sem aviso prévio. Os desenhos aqui contidos possuem medidas teóricas de massa e tolerâncias dimensionais de acordo com a ABNT NBR-8116, podendo haver variações dessas informações no produto final.

## ÍSIS 42 - PARA PORTAS DE ATÉ 2X3m

### Estrutura externa

(marco, contramarco e arremate)

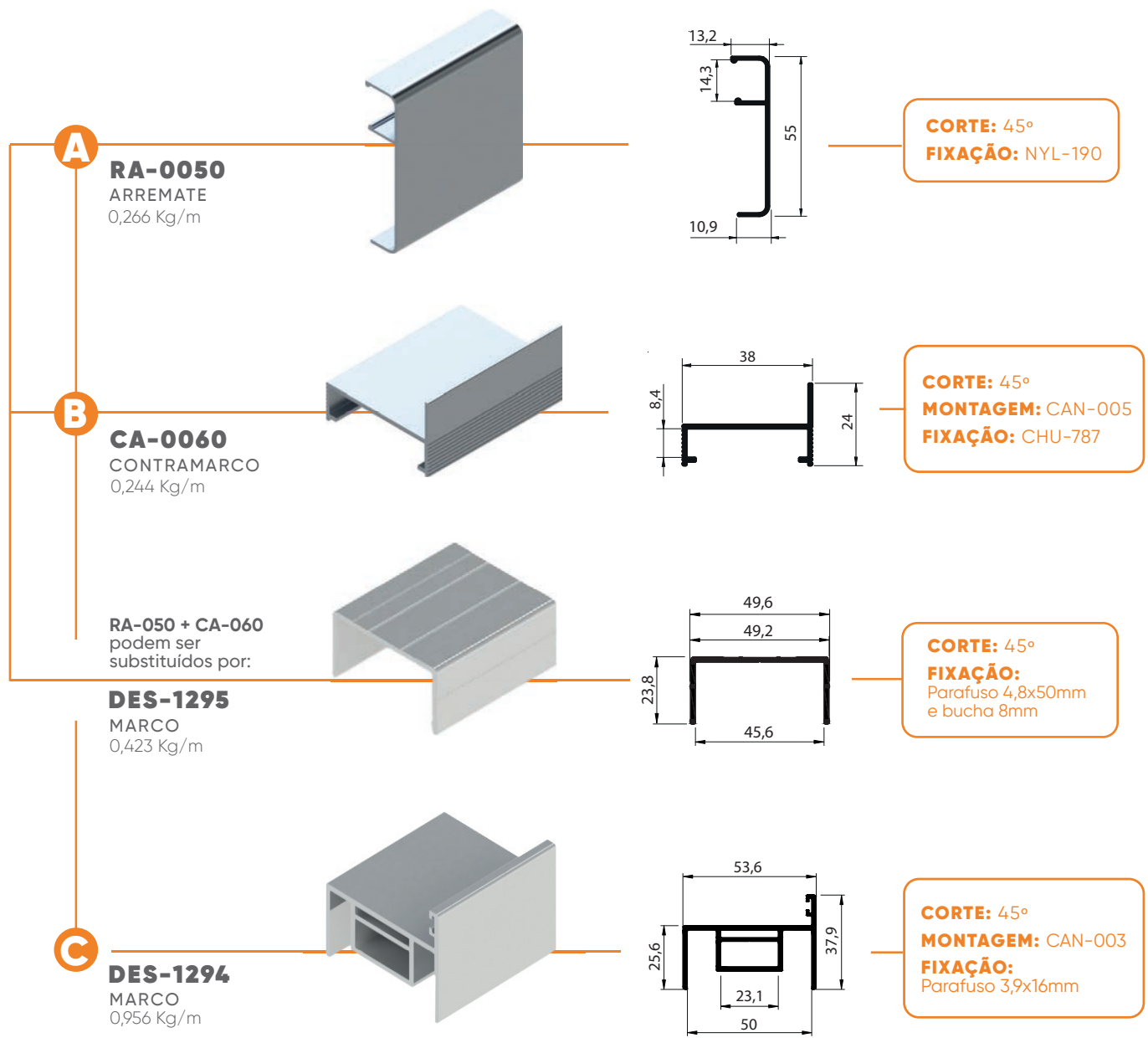

### Estrutura da porta

(folha | parte móvel)

**D**

**DES-1293**  
MONTANTES e  
TRAVESSAS EXTERNAS  
2,450 Kg/m

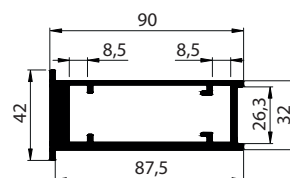
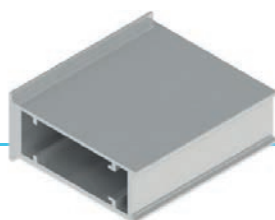

**CORTE: 45°**  
**MONTAGEM: CAN-004**  
**FIXAÇÃO: PIV-0350IN**

E

**DES-1483**  
TRAVESSAS CENTRAIS  
1,246 Kg/m

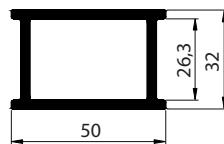
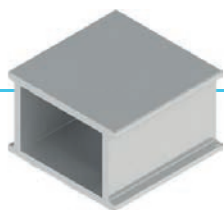

**CORTE:** Reto  
**FIXAÇÃO:** CAN-008

E

**DES-1482**  
TRAVESSAS CENTRAIS  
1,280 Kg/m

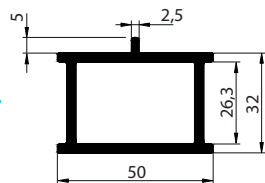
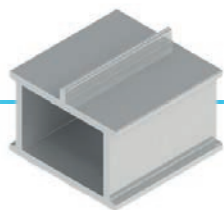

**CORTE:** Reto  
**FIXAÇÃO:** CAN-008

E

**DES-1481**  
TRAVESSAS CENTRAIS  
1,314 Kg/m

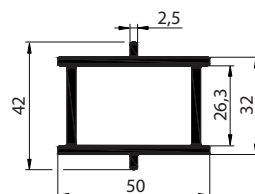

**CORTE:** Reto  
**FIXAÇÃO:** CAN-008

**Puxador**

**DES-2076**  
MONTANTE PUXADOR  
USINADO 42 P/ LED  
2,160 Kg/m

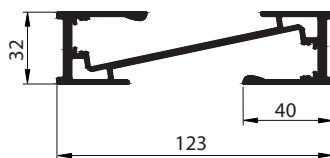
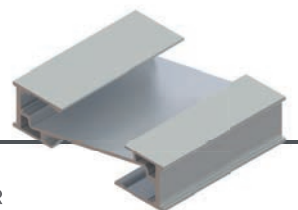

**CORTE:** Reto  
**FIXAÇÃO:** CAN-008  
**DIFUSOR:** DIF-001

## Componentes | Ísis 42

F

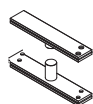

**Pivô**  
PIV-0350IN

G

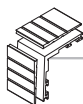

**Canto e Cunha**  
CAN-003, CAN-004  
E CAN-005

H

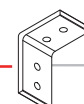

**Cantoneira**  
CAN-008

I

**Demais itens**



**Presilha**  
NYL-190



**Chumbador**  
CHU-787



**Esticador**  
ISIS-001



**Braçadeira**  
ISIS-002



**Cabo de Aço**  
ISIS-003

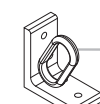

**Cantoneira**  
CAN-009

## Ísis 55 - PARA PORTAS DE ATÉ 2X5,2m

### Estrutura externa

(marco, contramarco e arremate)

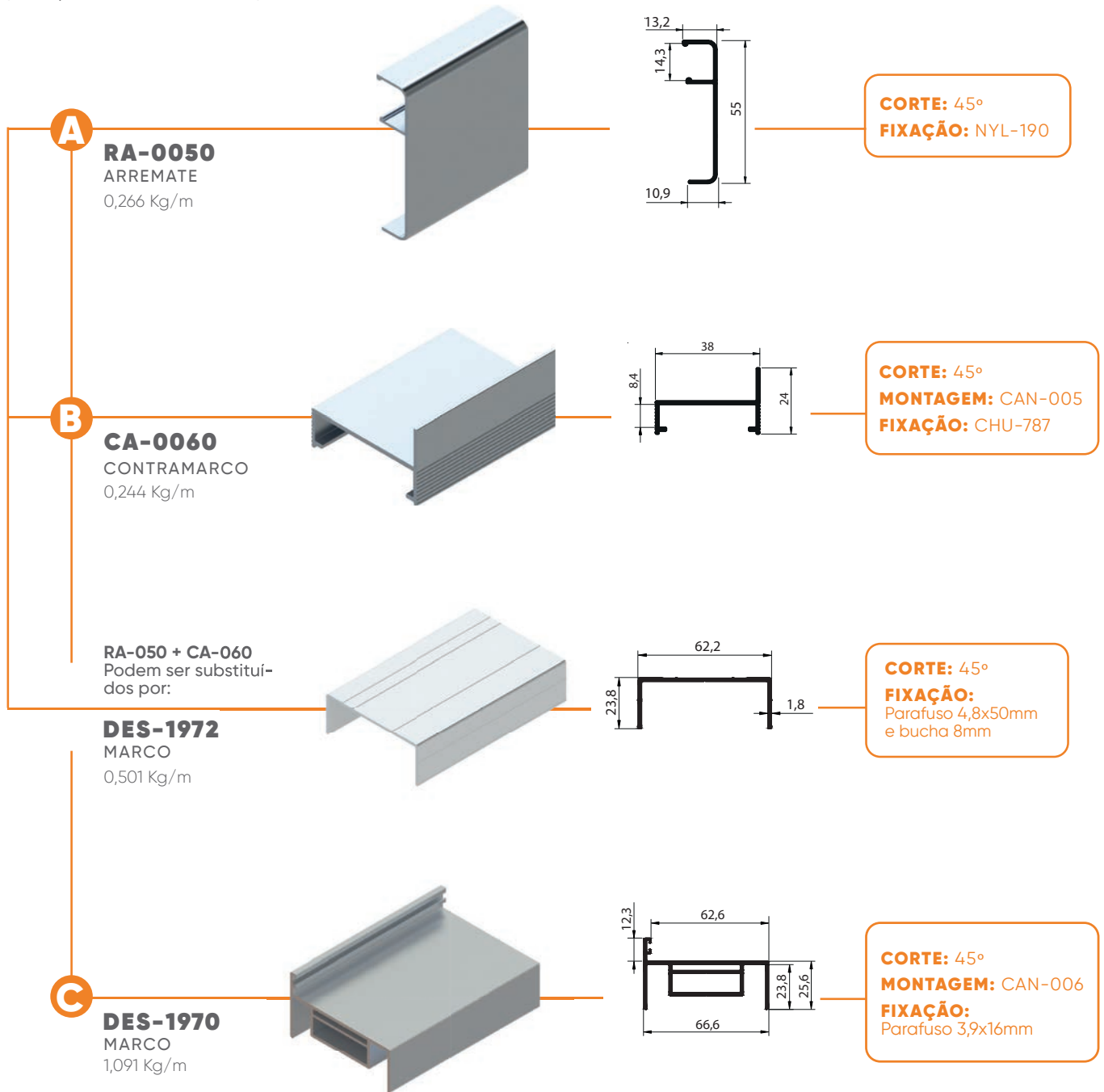



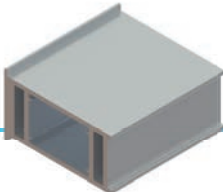
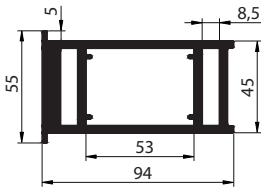
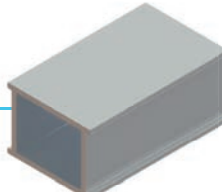
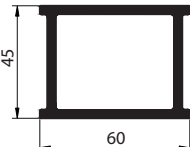
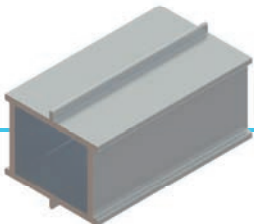
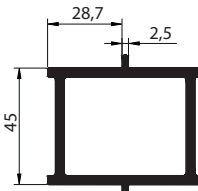
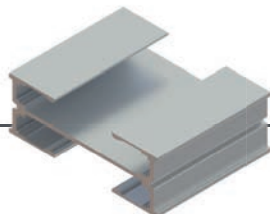
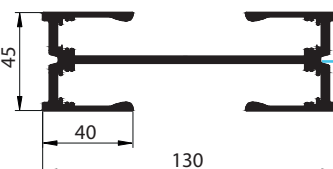

Ísis 55 - PARA PORTAS DE ATÉ 2X5,2m

**Estrutura da porta**

(folha | parte móvel)

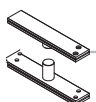
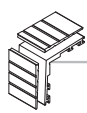
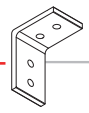
<b>D</b>	<p><b>DES-1969</b> MONTANTES e TRAVESSAS EXTERNAS 4,037 Kg/m</p>			<p><b>CORTE:</b> 45° <b>MONTAGEM:</b> CAN-007 <b>FIXAÇÃO:</b> PIV-0350IN</p>
<b>E</b>	<p><b>DES-1998</b> TRAVESSAS CENTRAIS 1,799 Kg/m</p>			<p><b>CORTE:</b> Reto <b>FIXAÇÃO:</b> CAN-010</p>
<b>E</b>	<p><b>DES-1971</b> TRAVESSAS CENTRAIS 1,955 Kg/m</p>			<p><b>CORTE:</b> Reto <b>FIXAÇÃO:</b> CAN-010</p>
	<p><b>Puxador</b></p> <p><b>DES-2077</b> MONTANTE PUXADOR USINADO 55 P/ LED 2,954 Kg/m</p>			<p><b>CORTE:</b> Reto <b>FIXAÇÃO:</b> CAN-010 <b>DIFUSOR:</b> DIF-001</p>

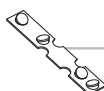
**Componentes | Ísis 55**

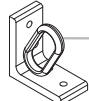
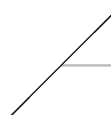
<b>F</b>	 <p><b>Pivô</b> PIV-0350IN</p>	<b>G</b>	 <p><b>Canto e Cunha</b> CAN-006 E CAN-007</p>	<b>H</b>	 <p><b>Cantoneira</b> CAN-010</p>
<b>I</b>	<b>Demais itens</b>				
	 <p><b>Presilha</b> NYL-190</p>	 <p><b>Chumbador</b> CHU-787</p>	 <p><b>Esticador</b> ISIS-001</p>	 <p><b>Cantoneira</b> CAN-011</p>	 <p><b>Cabo de Aço</b> ISIS-004</p>

A ALUMICONTE reserva-se o direito de fazer modificações em qualquer informação escrita neste catálogo sem aviso prévio. Os desenhos aqui contidos possuem medidas teóricas de massa e tolerâncias dimensionais de acordo com a ABNT NBR-8116, podendo haver variações dessas informações no produto final.

## PORTA DE PASSAGEM

Projetados para suportar portas de passagem suspensas, os perfis trilhos superiores garantem deslizamento suave, instalação prática e acabamento refinado. Ideais para dividir ambientes com leveza e modernidade, sem a necessidade de trilho inferior.

### DES-036

Trilho Superior Simples  
0,583 Kg/m

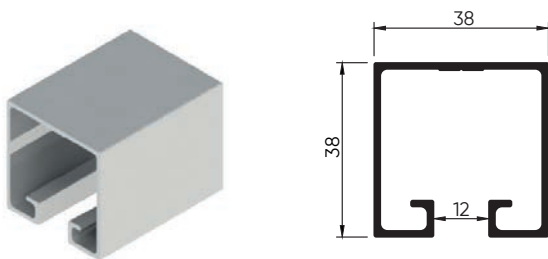

### DES-037

Trilho Superior Simples (Roldana Côncava)  
0,501 Kg/m

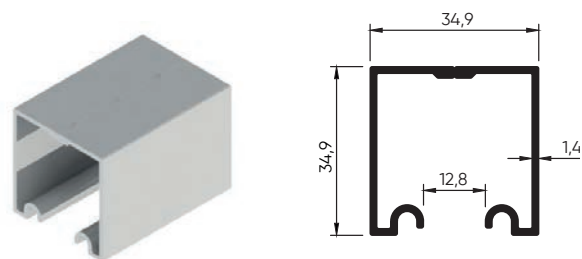

### DES-044

Trilho Superior Simples (Roldana Côncava)  
0,494 Kg/m

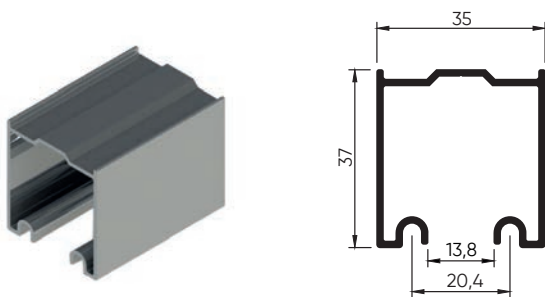

### DES-200

Trilho Superior Simples (Roldana Côncava)  
0,577 Kg/m

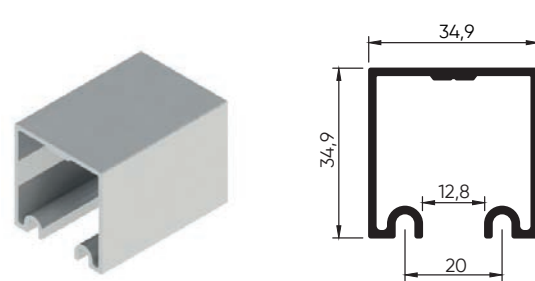

### DES-261

Trilho Superior Simples com Encaixe Bandeira  
0,623 Kg/m

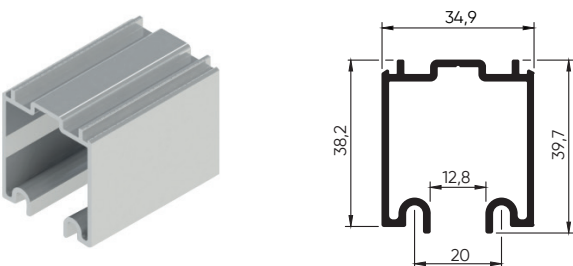

### DES-167

Trilho Superior Simples (Roldana Convexa)  
0,431 Kg/m

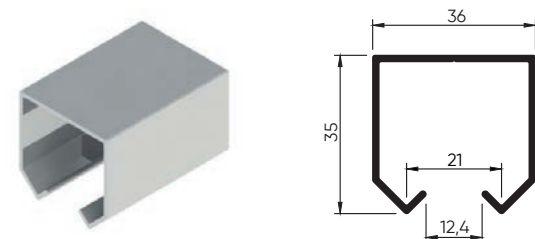

### DES-039

Trilho Superior Simples (Roldana Convexa)  
0,432 Kg/m

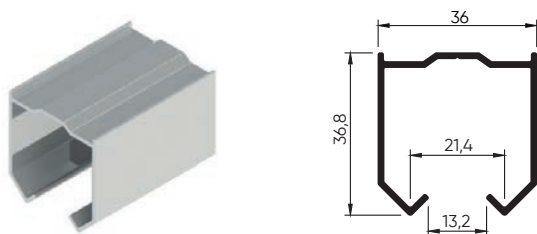

### DES-886

Trilho Superior Simples (Roldana Convexa)  
0,572 Kg/m

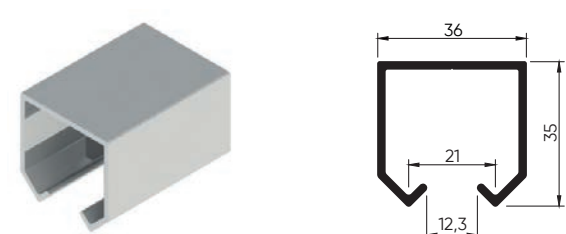

A ALUMICONTE reserva-se o direito de fazer modificações em qualquer informação escrita neste catálogo sem aviso prévio. Os desenhos aqui contidos possuem medidas teóricas de massa e tolerâncias dimensionais de acordo com a ABNT NBR-8116, podendo haver variações dessas informações no produto final.

## PORTA DE PASSAGEM DE VIDRO

Soluções perfeitas para compor portas de vidro entre ambientes. Esses perfis oferecem fixação firme, visual limpo e design sofisticado, valorizando a amplitude dos espaços com praticidade e estilo.

### DES-1721

Marco Regulável  
0,875 Kg/m

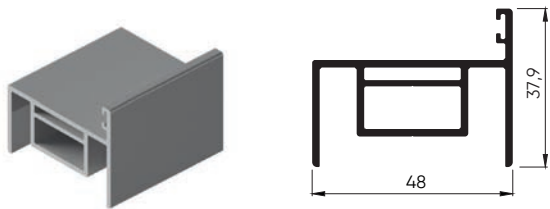

### DES-1722

Estrutural Marco Regulável  
0,418 Kg/m

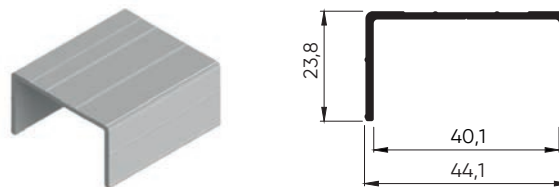

### DES-1302

Marco Perimetral  
0,347 Kg/m

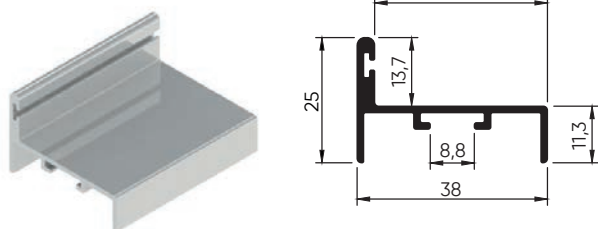

### DES-1510

Montante Vidro Duplo  
0,961 Kg/m

Compatível • MONTAGEM  
DES-1512 | DES-1514

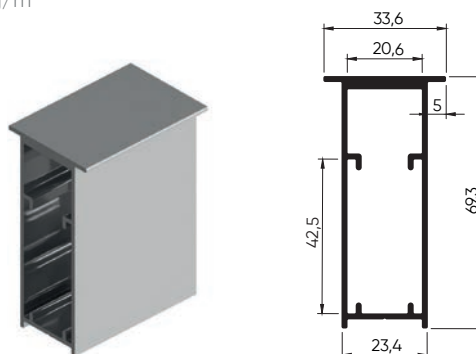

### DES-1512

Travessa Vidro Duplo  
0,987 Kg/m

Compatível • MONTAGEM  
DES-1510 | DES-1511 | DES-1514

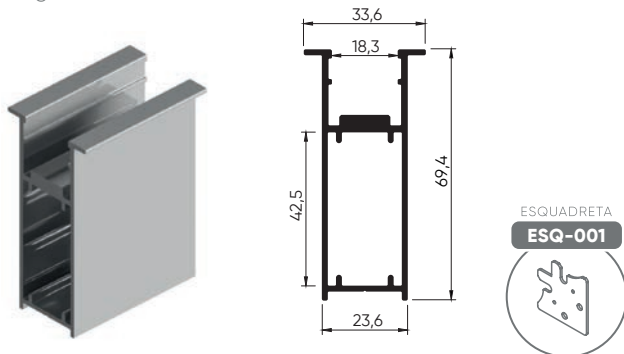

### DES-1511

Montante Vidro Duplo  
0,961 Kg/m

Compatível • MONTAGEM  
DES-1510 | DES-1512 | DES-1514

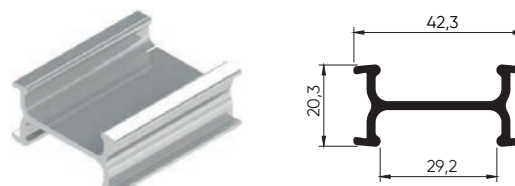

### DES-1514

Travessa Divisória  
0,532 Kg/m

Compatível • MONTAGEM  
DES-1510 | DES-1511 | DES-1512

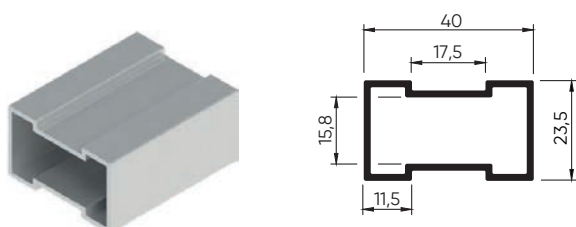

### BXT-505

Fixação Travessa  
0,467 Kg/m

Compatível • MONTAGEM  
DES-1514

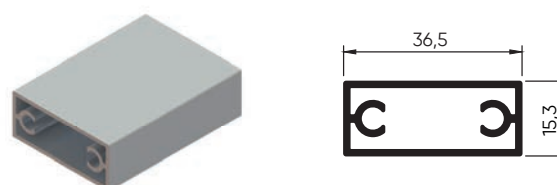

A ALUMICONTE reserva-se o direito de fazer modificações em qualquer informação escrita neste catálogo sem aviso prévio. Os desenhos aqui contidos possuem medidas teóricas de massa e tolerâncias dimensionais de acordo com a ABNT NBR-8116, podendo haver variações dessas informações no produto final.

### DES-599

Travessa Inferior Divisória de Ambiente

0,758 Kg/m

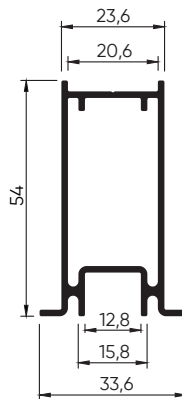
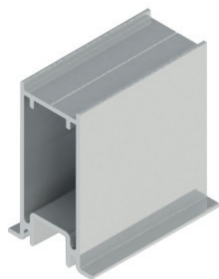

Compatível • MONTAGEM

DES-597 | DES-599 | DES-600 | DES-2344

### DES-597

Travessa Intermediária Dupla

0,533 Kg/m

Compatível • MONTAGEM

DES-598 | DES-599

DES-600 | DES-2344

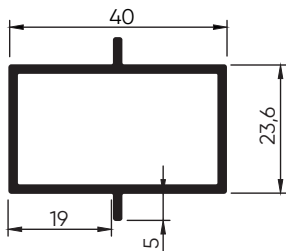
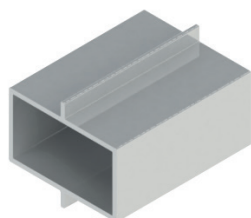

### DES-598

Travessa Intermediária

0,513 Kg/m

Compatível • MONTAGEM

DES-597 | DES-599 | DES-600 | DES-2344

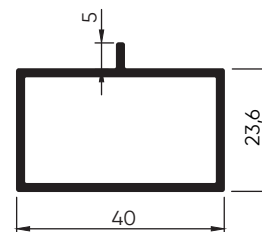
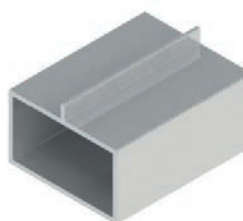

### DES-600

Travessa Superior Divisória de Ambiente

0,810 Kg/m

Compatível • MONTAGEM

DES-597 | DES-598 | DES-599 | DES-2344

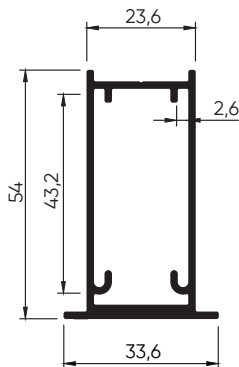
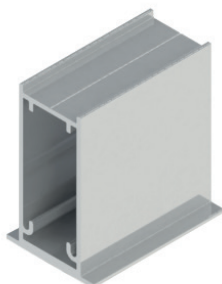

### DES-2344

Arremate de Folha

0,202 Kg/m

Compatível • MONTAGEM

DES-597 | DES-598

DES-599 | DES-600

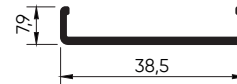
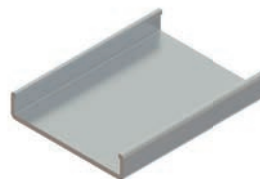

### DES-2343

Batente para Porta de Correr

0,788 Kg/m

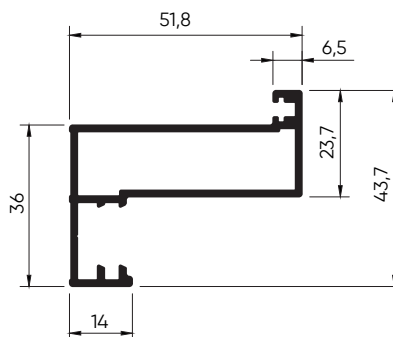
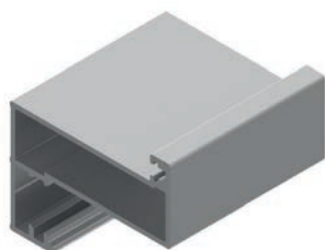

RECEBE LED



DIFUSOR

DIF-001



A ALUMICONTE reserva-se o direito de fazer modificações em qualquer informação escrita neste catálogo sem aviso prévio. Os desenhos aqui contidos possuem medidas teóricas de massa e tolerâncias dimensionais de acordo com a ABNT NBR-8116, podendo haver variações dessas informações no produto final.

### DES-1517

Montante Vidro Duplo  
0,738 Kg/m

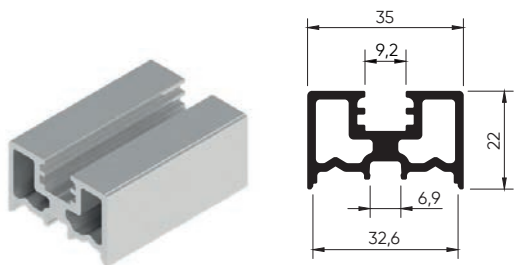

BAGUETE  
**BAG-003**

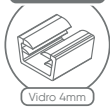

BAGUETE  
**BAG-015**

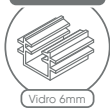

### DES-1518

Capa Montante  
0,140 Kg/m

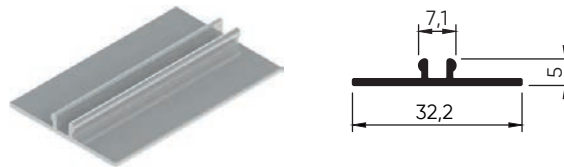

### DES-1519

Travessa Divisória  
0,783 Kg/m

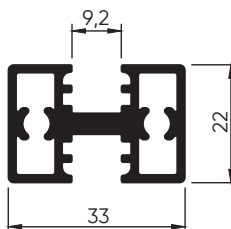
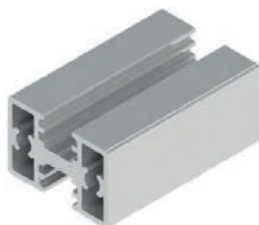

BAGUETE  
**BAG-003**



BAGUETE  
**BAG-015**



### DES-1516

Travessa Sup./Inf. Vidro Duplo  
0,851 Kg/m

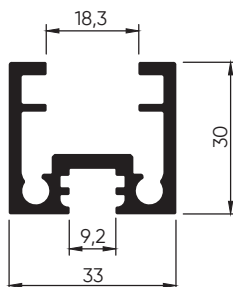

#### ADP-1516

Adaptador para porta de passagens



BAGUETE  
**BAG-003**



BAGUETE  
**BAG-015**



### DES-1526

Perfil Travessa Superior  
0,962 Kg/m

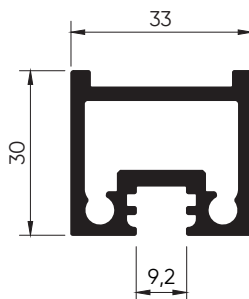

BAGUETE  
**BAG-003**



BAGUETE  
**BAG-015**



A ALUMICONTE reserva-se o direito de fazer modificações em qualquer informação escrita neste catálogo sem aviso prévio. Os desenhos aqui contidos possuem medidas teóricas de massa e tolerâncias dimensionais de acordo com a ABNT NBR-8116, podendo haver variações dessas informações no produto final.

## PORTA DE CORRER

Perfis que garantem o deslizamento suave e estável das portas de correr, com encaixe preciso e acabamento moderno para armários funcionais e elegantes.

### DES-035

Trilho Superior Simples  
0,387 Kg/m

Compatível • MONTAGEM  
DES-041 | DES-055  
DES-155 | DES-315

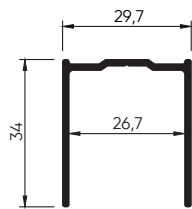
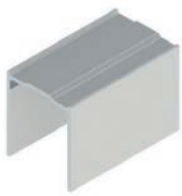

### DES-944

Trilho Superior Simples  
0,317 Kg/m

Compatível • MONTAGEM  
DES-041 | DES-055  
DES-155 | DES-315

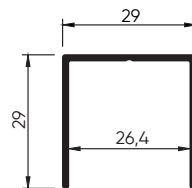
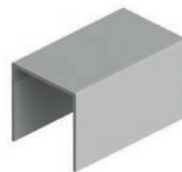

### DES-1433

Trilho Superior Simples  
0,545 Kg/m

Compatível • MONTAGEM  
DES-041 | DES-055  
DES-155 | DES-315

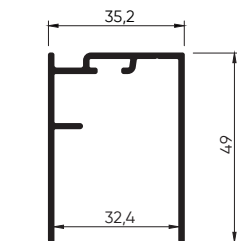

### DES-980

Trilho Superior Simples  
0,301 Kg/m

Compatível • MONTAGEM  
DES-041 | DES-055  
DES-155 | DES-315

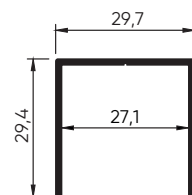

### DES-992

Trilho Superior Simples  
0,249 Kg/m

Compatível • MONTAGEM  
DES-041 | DES-055  
DES-155 | DES-315

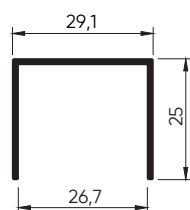
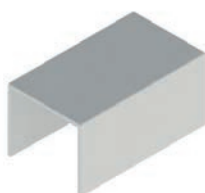

### DES-041

Trilho Inferior Simples  
0,124 Kg/m

Compatível • MONTAGEM  
DES-035 | DES-944 | DES-1433  
DES-980 | DES-992

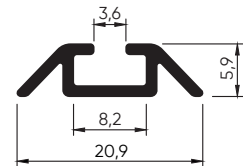
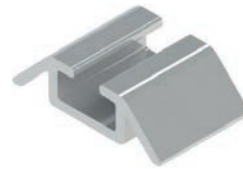

### DES-055

Trilho Inferior Simples de Embutir  
0,088 Kg/m

Compatível • MONTAGEM  
DES-035 | DES-944 | DES-1433  
DES-980 | DES-992

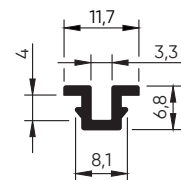

### DES-155

Trilho Inferior Simples  
0,085 Kg/m

Compatível • MONTAGEM  
DES-035 | DES-944 | DES-1433  
DES-980 | DES-992

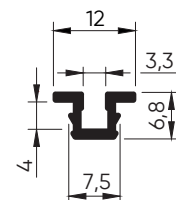

### DES-315

Trilho Inferior Simples de Embutir  
0,110 Kg/m

Compatível • MONTAGEM  
DES-035 | DES-944 | DES-1433  
DES-980 | DES-992

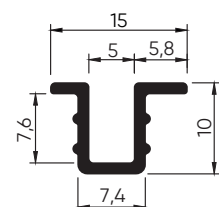

A ALUMICONTE reserva-se o direito de fazer modificações em qualquer informação escrita neste catálogo sem aviso prévio. Os desenhos aqui contidos possuem medidas teóricas de massa e tolerâncias dimensionais de acordo com a ABNT NBR-8116, podendo haver variações dessas informações no produto final.

### DES-038

Trilho Superior Duplo  
0,492 Kg/m



Compatível • MONTAGEM  
DES-113 | DES-294 | DES-512 | DES-058

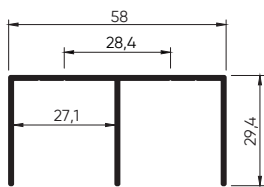

### DES-156

Trilho Superior Duplo  
0,435 Kg/m



Compatível • MONTAGEM  
DES-113 | DES-294 | DES-512 | DES-058

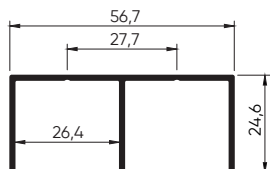

### DES-390

Trilho Superior Duplo  
0,441 Kg/m

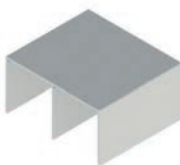

Compatível • MONTAGEM  
DES-113 | DES-294 | DES-512 | DES-058

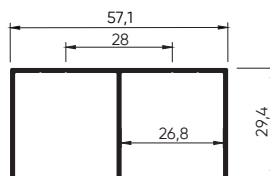

### DES-287

Trilho Superior Duplo Aba Convexa  
0,589 Kg/m

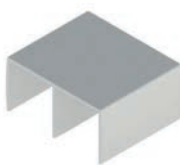

Compatível • MONTAGEM  
DES-113 | DES-294  
DES-512 | DES-058

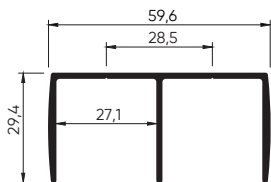

### DES-511

Trilho Superior Duplo  
0,465 Kg/m

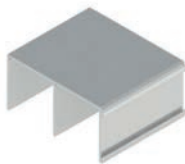

Compatível • MONTAGEM  
DES-113 | DES-294 | DES-512 | DES-058

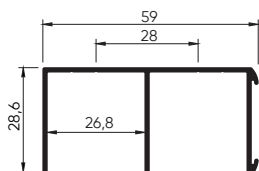

### DES-524

Trilho Superior Duplo  
0,393 Kg/m



Compatível • MONTAGEM  
DES-113 | DES-294 | DES-512 | DES-058

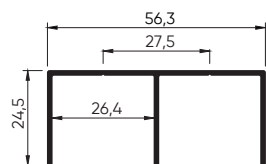

### DES-113

Trilho Inferior Duplo  
0,232 Kg/m

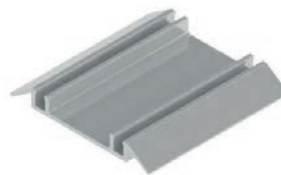

Compatível • MONTAGEM  
DES-038 | DES-156 | DES-390  
DES-287 | DES-511 | DES-524

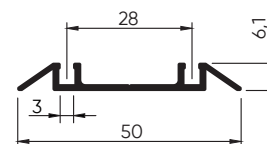

### DES-294

Trilho Inferior Duplo  
0,275 Kg/m

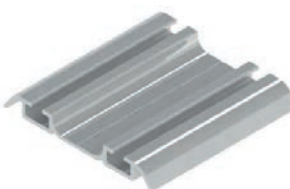

Compatível • MONTAGEM  
DES-038 | DES-156 | DES-390  
DES-287 | DES-511 | DES-524

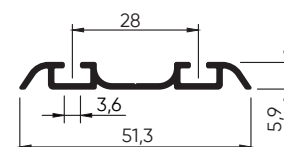

### DES-512

Trilho Inferior Duplo  
0,231 Kg/m



Compatível • MONTAGEM  
DES-038 | DES-156 | DES-390  
DES-287 | DES-511 | DES-524

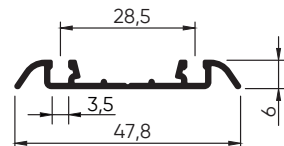

### DES-058

Trilho Inferior Duplo  
0,249 Kg/m

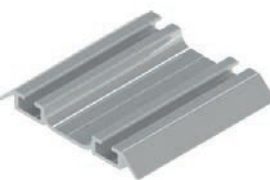

Compatível • MONTAGEM  
DES-038 | DES-156 | DES-390  
DES-287 | DES-511 | DES-524

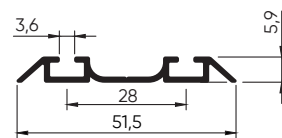

A ALUMICONTE reserva-se o direito de fazer modificações em qualquer informação escrita neste catálogo sem aviso prévio. Os desenhos aqui contidos possuem medidas teóricas de massa e tolerâncias dimensionais de acordo com a ABNT NBR-8116, podendo haver variações dessas informações no produto final.

### DES-032

**Trilho Superior Duplo**  
0,665 Kg/m

Compatível • MONTAGEM  
DES-228 | DES-051

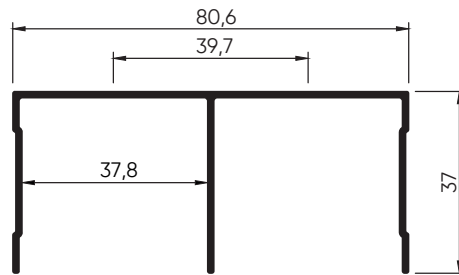
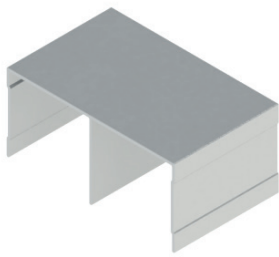

### DES-228

**Trilho Inferior Duplo**  
0,213 Kg/m

Compatível • MONTAGEM  
DES-032



### DES-051

**Trilho Inferior Duplo**  
0,302 Kg/m

Compatível • MONTAGEM  
DES-032

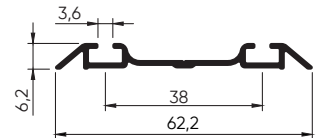
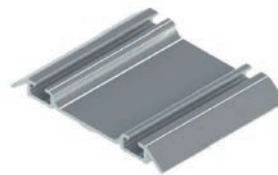

### DES-1434

**Trilho Superior Duplo**  
0,910 Kg/m

Compatível • MONTAGEM  
DES-344 | DES-603 | DES-843

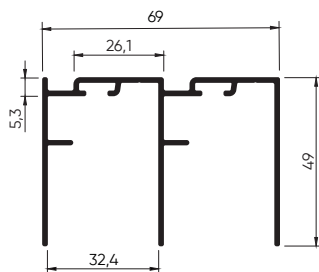
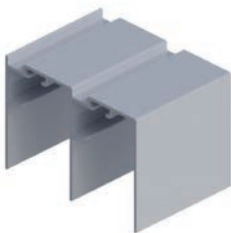

### DES-344

**Trilho Inferior Duplo**  
0,294 Kg/m

Compatível • MONTAGEM  
DES-1434 | DES-601

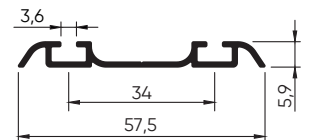

### DES-601

**Trilho Superior Duplo**  
0,534 Kg/m

Compatível • MONTAGEM  
DES-344 | DES-603 | DES-843

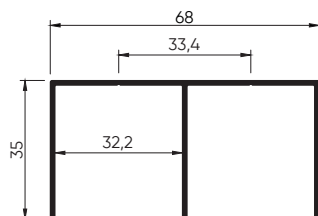

### DES-603

**Trilho Inferior Duplo**  
0,238 Kg/m

Compatível • MONTAGEM  
DES-1434 | DES-601

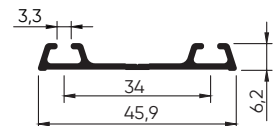
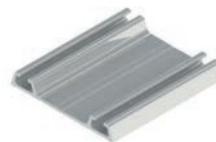

### DES-843

**Trilho Inferior Duplo**  
0,257 Kg/m

Compatível • MONTAGEM  
DES-1434 | DES-601

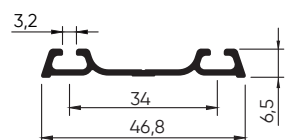

A ALUMICONTE reserva-se o direito de fazer modificações em qualquer informação escrita neste catálogo sem aviso prévio. Os desenhos aqui contidos possuem medidas teóricas de massa e tolerâncias dimensionais de acordo com a ABNT NBR-8116, podendo haver variações dessas informações no produto final.

## DES-844

Trilho Superior Duplo  
0,461 Kg/m

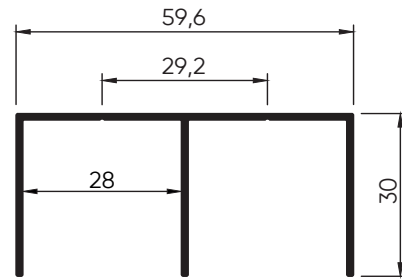
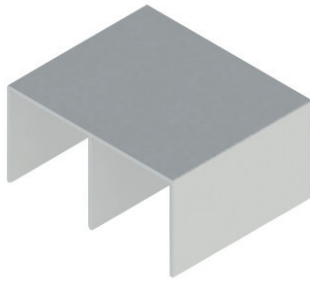

Compatível • MONTAGEM  
DES-042 | DES-188 | DES-309  
DES-820 | DES-1284

## DES-042

Trilho Inferior Duplo  
0,235 Kg/m

Compatível • MONTAGEM  
DES-844

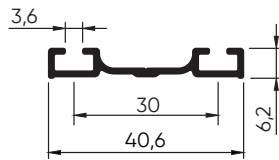

## DES-188

Trilho Inferior Duplo  
0,337 Kg/m

Compatível • MONTAGEM  
DES-844

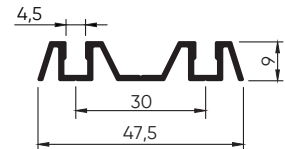

## DES-309

Trilho Inferior Duplo  
0,267 Kg/m

Compatível • MONTAGEM  
DES-844

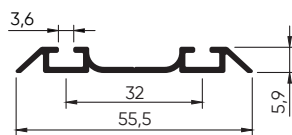
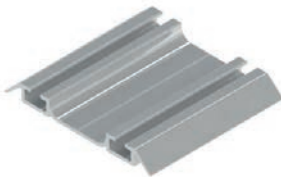

## DES-820

Trilho Inferior Duplo  
0,295 Kg/m

Compatível • MONTAGEM  
DES-844

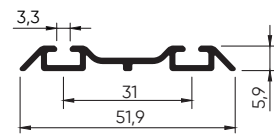
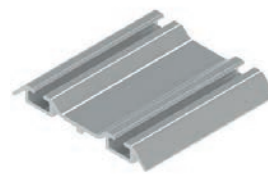

## DES-1284

Trilho Inferior Duplo  
0,288 Kg/m

Compatível • MONTAGEM  
DES-844

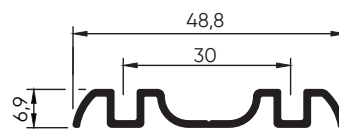
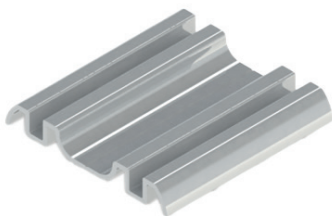

A ALUMICONTE reserva-se o direito de fazer modificações em qualquer informação escrita neste catálogo sem aviso prévio. Os desenhos aqui contidos possuem medidas teóricas de massa e tolerâncias dimensionais de acordo com a ABNT NBR-8116, podendo haver variações dessas informações no produto final.

### DES-334

Montante Puxador Porta de Correr  
0,613 Kg/m

Compatível • MONTAGEM  
DES-257 | DES-260

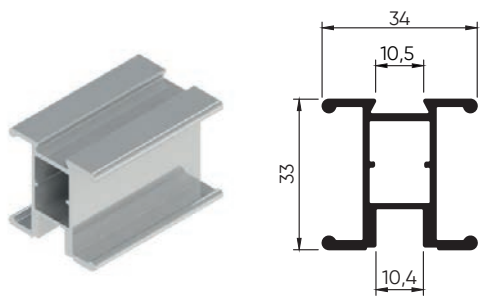

### DES-259

Montante Puxador Porta de Correr  
0,680Kg/m

Compatível • MONTAGEM  
DES-257 | DES-258 | DES-260

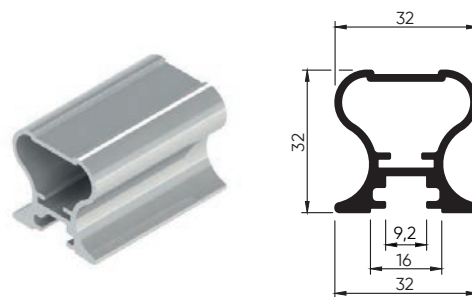

### DES-257

Travessa Inferior para Porta Deslizante  
0,594 Kg/m

Compatível • MONTAGEM  
DES-258 | DES-260

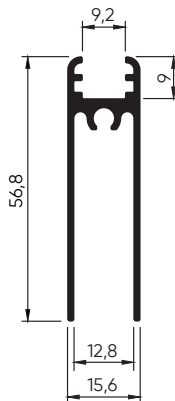
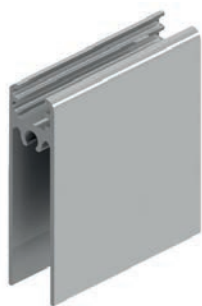

### DES-260

Travessa Superior 8mm  
0,749 Kg/m

Compatível • MONTAGEM  
DES-258 | DES-260

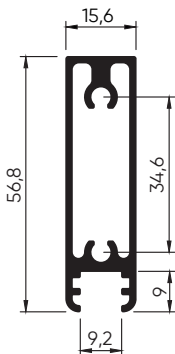

### DES-258

Travessa Intermediária Porta de Correr  
0,491 Kg/m

Compatível • MONTAGEM  
DES-257 | DES-260

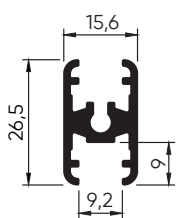

### DES-874

Travessa Superior/Inferior Porta de Correr  
0,279 Kg/m

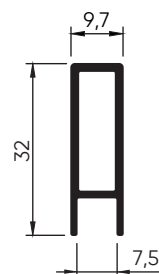

A ALUMICONTE reserva-se o direito de fazer modificações em qualquer informação escrita neste catálogo sem aviso prévio. Os desenhos aqui contidos possuem medidas teóricas de massa e tolerâncias dimensionais de acordo com a ABNT NBR-8116, podendo haver variações dessas informações no produto final.

**DES-1445**  
Montante Estrutural  
0,758 Kg/m

Compatível • MONTAGEM  
DES-1413

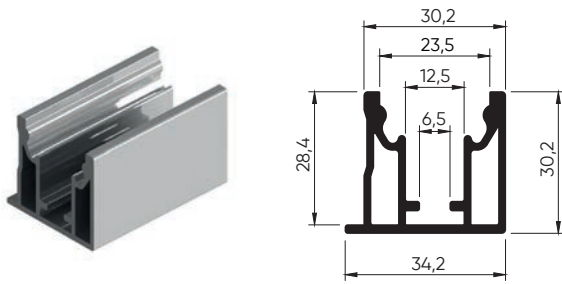

**DES-1412**  
Montante Estrutural  
0,724 Kg/m

Compatível • MONTAGEM  
DES-1413

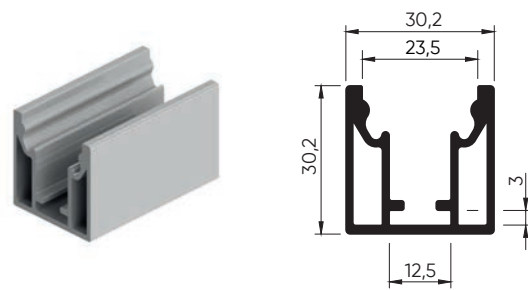

**DES-1413**  
Capa Montante Estrutural  
0,209 Kg/m

Compatível • MONTAGEM  
DES-1412 | DES-1445

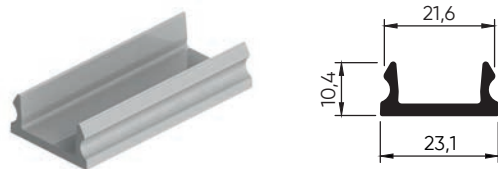

**DES-932**  
Estrutural Vitrine  
1,081 Kg/m

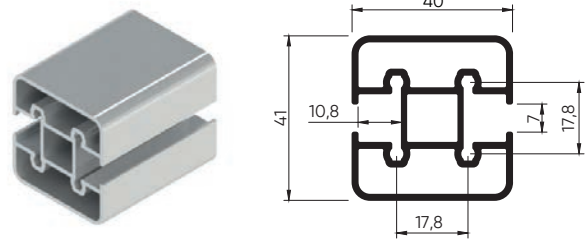

**DES-1304**  
Quadro do Vidro Sistema Prateleira LED  
0,709 Kg/m

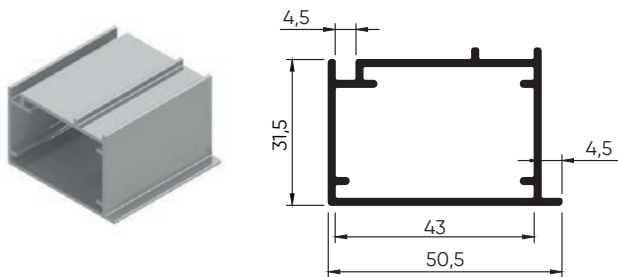

**DES-400**  
Estrutural Industrial 100x30  
1,858 Kg/m

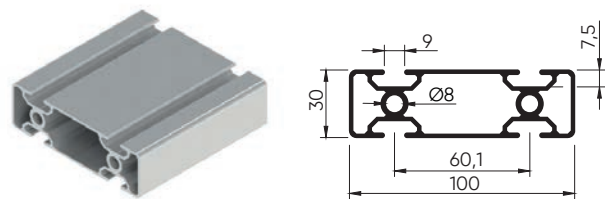

**DES-1409**  
Quadro Prateleira LED  
0,470 Kg/m

Compatível • MONTAGEM  
DES-1410 | DES-1411

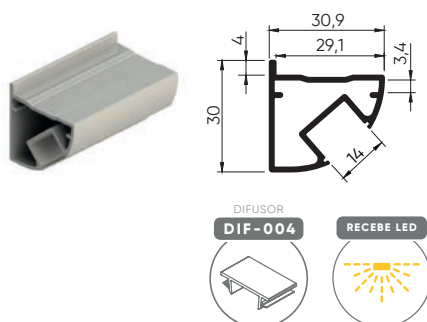

**DES-1410**  
Quadro Prateleira  
0,396 Kg/m

Compatível • MONTAGEM  
DES-1409 | DES-1411

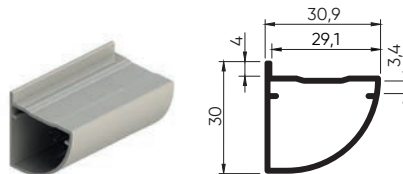

**DES-1411**  
Quadro Lateral Prateleira  
0,445 Kg/m

Compatível • MONTAGEM  
DES-1409 | DES-1410

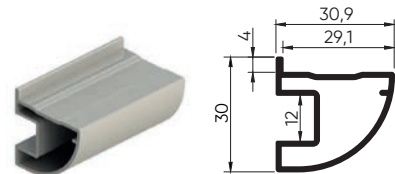

A ALUMICONTE reserva-se o direito de fazer modificações em qualquer informação escrita neste catálogo sem aviso prévio. Os desenhos aqui contidos possuem medidas teóricas de massa e tolerâncias dimensionais de acordo com a ABNT NBR-8116, podendo haver variações dessas informações no produto final.

**DES-248**

**Testeira Perimetral 18mm**  
0,207 Kg/m

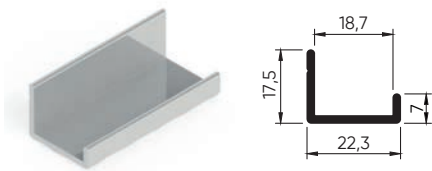

**DES-249**

**Testeira Perimetral 15mm**  
0,193 Kg/m

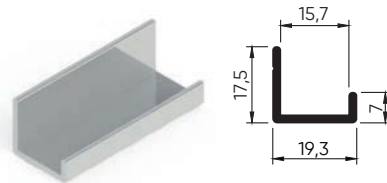

**DES-2639**

**Testeira Perimetral 15mm**  
0,108 Kg/m

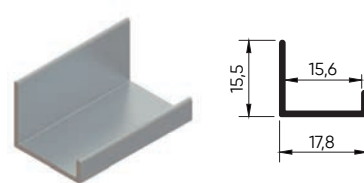

**DES-292**

**Testeira Perimetral 18mm**  
0,256 Kg/m

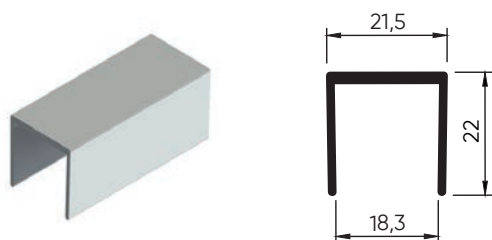

**DES-165**

**Trilho/Testeira 15mm**  
0,277 Kg/m

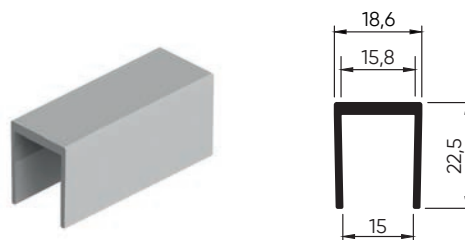

**DES-205**

**Trilho/Testeira 15mm**  
0,371 Kg/m

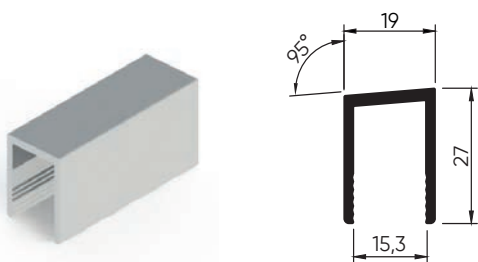

**DES-596**

**Testeira 15mm**  
0,283 Kg/m

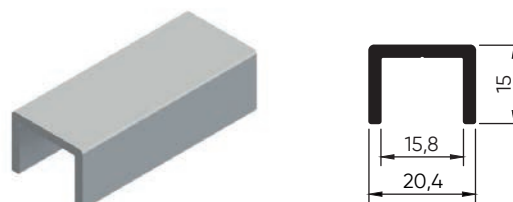

**DES-171**

**Perfil "U" 29x14mm**  
0,218 Kg/m



A ALUMICONTE reserva-se o direito de fazer modificações em qualquer informação escrita neste catálogo sem aviso prévio. Os desenhos aqui contidos possuem medidas teóricas de massa e tolerâncias dimensionais de acordo com a ABNT NBR-8116, podendo haver variações dessas informações no produto final.

**DES-694**

Testeira Perimetral 18mm  
0,165 Kg/m

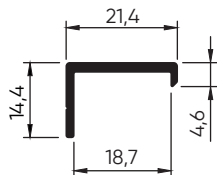
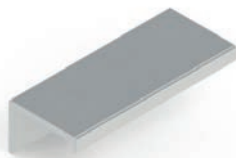

**DES-1620**

Testeira Perimetral 15mm  
0,146 Kg/m

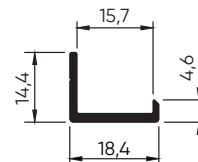

**DES-241**

Testeira Perimetral com Espiga 18mm  
0,172 Kg/m

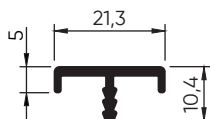
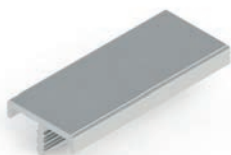

**DES-240**

Testeira Perimetral com Espiga 15mm  
0,157 Kg/m

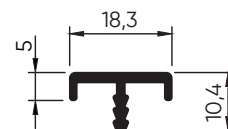
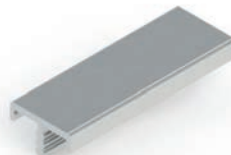

**DES-2090**

Perfil Divisor "H" 18mm  
0,552 Kg/m

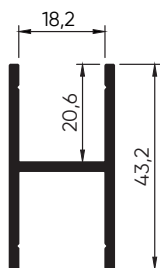
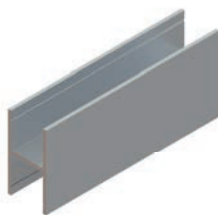

**DES-2089**

Perfil Divisor "H" 15mm  
0,533 Kg/m

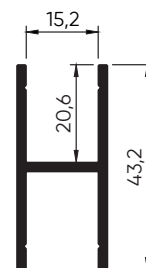
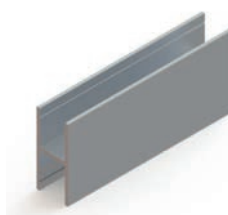

**DES-616**

Testeira Perimetral 18mm  
0,713 Kg/m

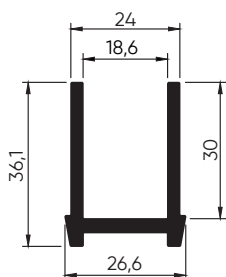

**DES-1281**

Estrutural Boleado  
0,944 Kg/m

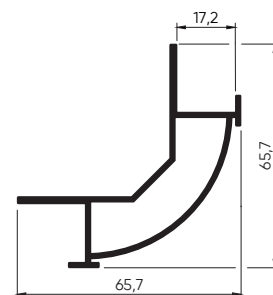

A ALUMICONTE reserva-se o direito de fazer modificações em qualquer informação escrita neste catálogo sem aviso prévio. Os desenhos aqui contidos possuem medidas teóricas de massa e tolerâncias dimensionais de acordo com a ABNT NBR-8116, podendo haver variações dessas informações no produto final.

### DES-3005

Canto MDF 15 com Borda  
0,518 Kg/m

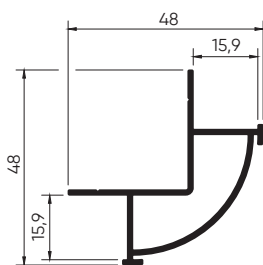
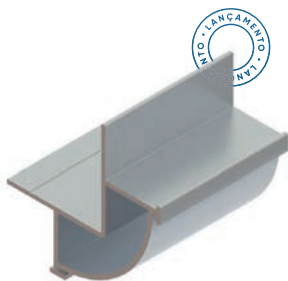

Demonstração de montagem



### DES-3006

Canto MDF 15 sem Borda  
0,576 Kg/m

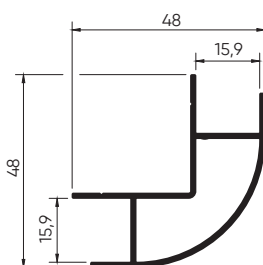
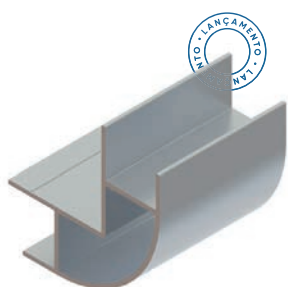

Demonstração de montagem



### DES-3007

Canto MDF 18 sem Borda  
0,576 Kg/m

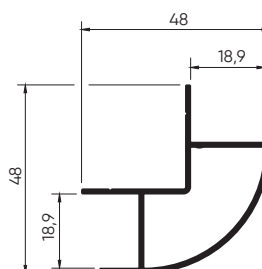
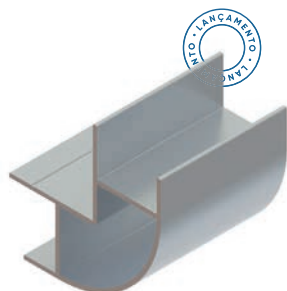

Demonstração de montagem em móveis para motorhome.  
PERFIL DES-3006



A ALUMICONTE reserva-se o direito de fazer modificações sem qualquer informação escrita neste catálogo sem aviso prévio. Os desenhos aqui contidos possuem medidas teóricas de massa e tolerâncias dimensionais de acordo com a ABNT NBR-8116, podendo haver variações dessas informações no produto final.

## RIPADOS

Sofisticação em cada detalhe. Perfis ripados com design contemporâneo para composições elegantes e cheias de personalidade.



Perfil Lambri  
Cód.: ALV-2513

ALUMICONTE  
*sensorial*

Uma coleção que traz perfis com geometrias exclusivas, desenhadas para despertar emoções e transformar ambientes através das sensações.

Perfil Ripado Sensia  
Cód.: ALV-2585



Perfil Ripado Visia  
Cód.: ALV-2583



AVUMICONTE é o único fabricante de ripados no Brasil. Os desenhos aqui colhidos possuem medidas teóricas de massa e tolerâncias dimensionais. Os produtos aqui colhidos são produtos finais.

**ALV-2582**

Perfil Ripado Tacta | Passo 120 mm

0,660 Kg/m

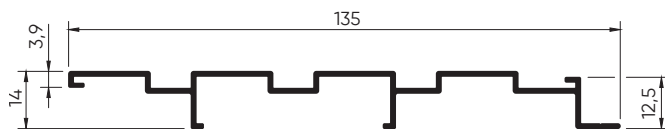
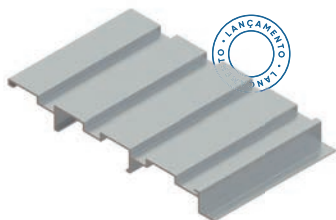
**ALV-2583**

Perfil Ripado Visia | Passo 118 mm

0,735 Kg/m

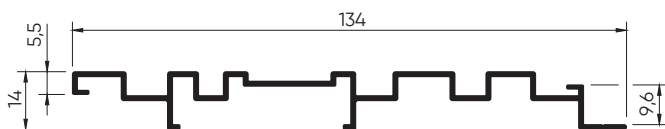
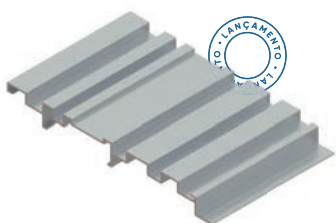
**ALV-2584**

Perfil Ripado Ecoar | Passo 120 mm

0,647 Kg/m

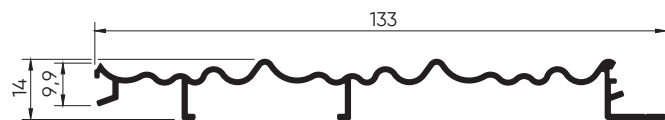
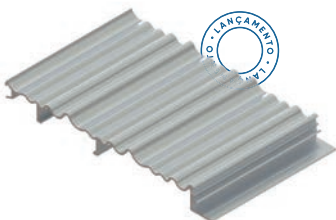
**ALV-2585**

Perfil Ripado Sensia | Passo 90 mm

0,554 Kg/m

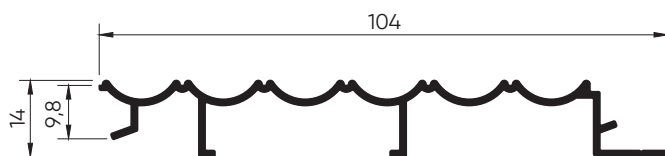
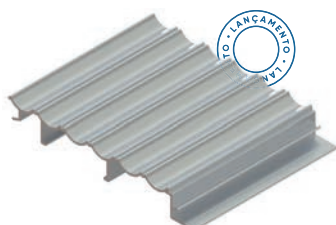

ALUMICONTE  
*sensorial*

Perfil Ripado Tacta  
Cód.: ALV-2582

A ALUMICONTE reserva-se o direito de fazer modificações em qualquer informação escrita neste catálogo sem aviso prévio. Os desenhos aqui contidos possuem medidas aproximadas e não representam a massa e as dimensões dimensionais de acordo com o ABNT NBR-8116, podendo haver variações dessas informações no produto final.



Perfil Ripado Ecoar  
Cód.: ALV-2584



**ALV-2513**

Perfil Lambri Contemporâneo | Passo 73mm

0,708Kg/m

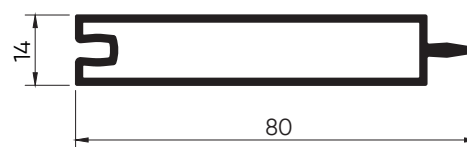
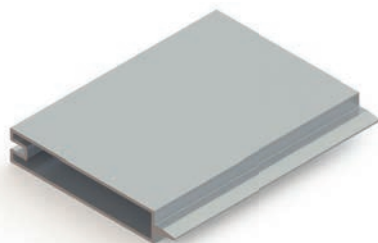
**DES-1290**

Ondulado 72 X 3,6 mm

0,291 Kg/m

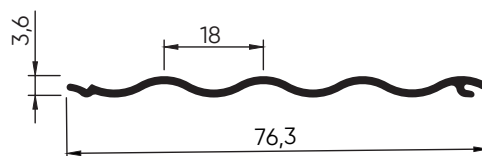
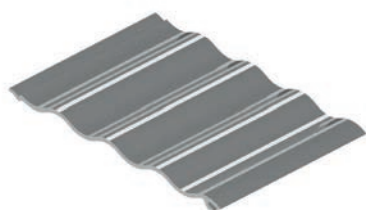

## ALV-2511

Lambri Ripado | Passo 135mm | Recebe LED

1,017 Kg/m

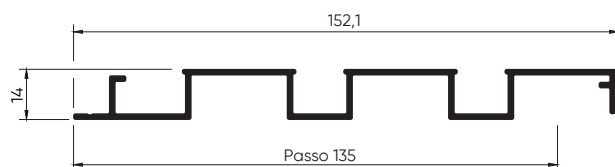
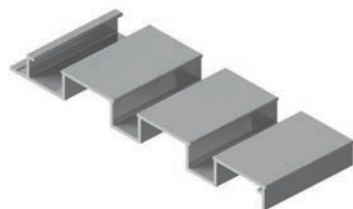

RECEBE LED



DIFUSOR

DIF-004



## ALV-2512

Lambri Ripado | Passo 120mm

1,087 Kg/m

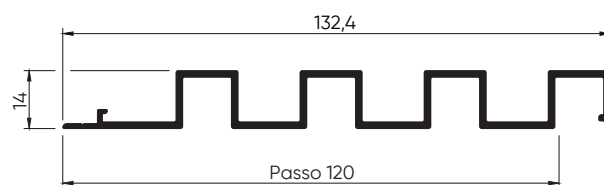
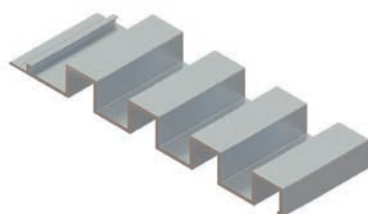

## ALV-2518

Perfil Ripado | Passo 135 | Leve

0,800 Kg/m

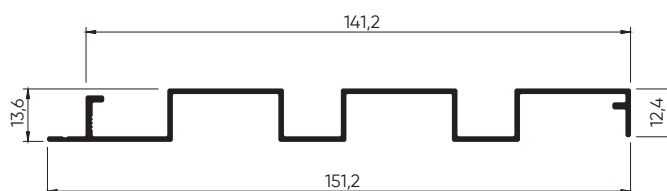
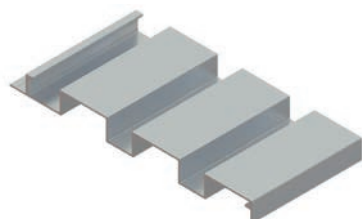

### DES-006

Trilho Esquadrias Madeira  
0,181 Kg/m

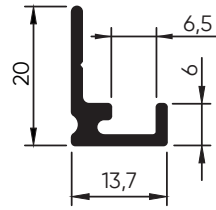

### DES-027

Trilho Esquadrias Madeira  
0,161 Kg/m

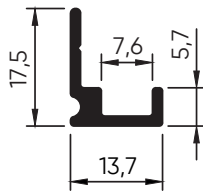

### DES-028

Trilho Esquadrias Madeira  
0,138 Kg/m

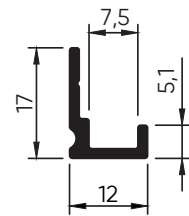

### DES-059

Trilho Esquadrias Madeira  
0,222 Kg/m

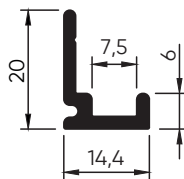

### DES-164

Trilho Esquadrias Madeira  
0,265 Kg/m

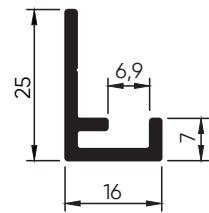
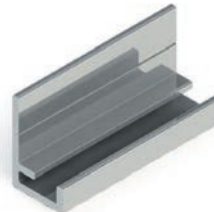

### DES-242

Trilho Esquadrias Madeira  
0,166 Kg/m

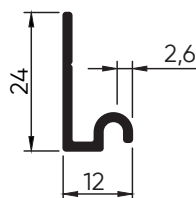

### DES-033

Trilho Esquadrias Madeira  
0,792 Kg/m

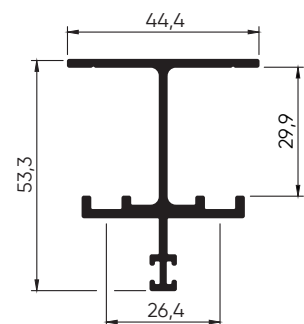
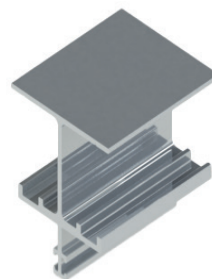

A ALUMICONTE reserva-se o direito de fazer modificações em qualquer informação escrita neste catálogo sem aviso prévio. Os desenhos aqui contidos possuem medidas teóricas de massa e tolerâncias dimensionais de acordo com a ABNT NBR-8116, podendo haver variações dessas informações no produto final.

### DES-034

Trilho Esquadrias Madeira

0,542 Kg/m

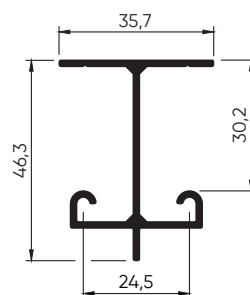

### DES-040

Trilho Esquadrias Madeira

0,616 Kg/m

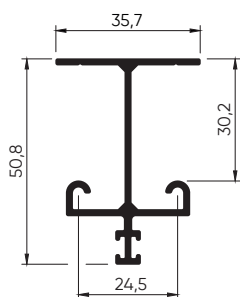

### DES-166

Trilho Esquadrias Madeira

1,434 Kg/m

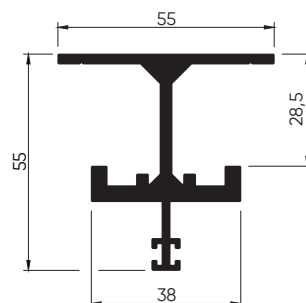
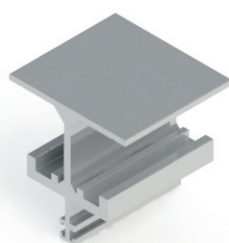

### DES-876

Trilho Esquadrias Madeira

0,647 Kg/m

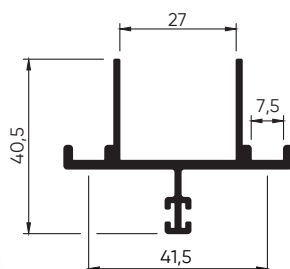
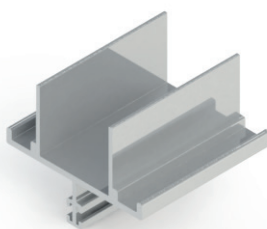

### DES-029

Trilho Esquadrias Madeira

0,179 Kg/m

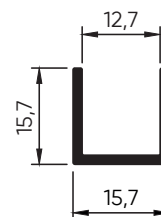
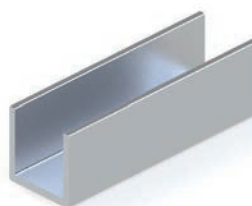

### DES-031

Trilho Esquadrias Madeira

0,140 Kg/m

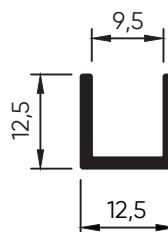
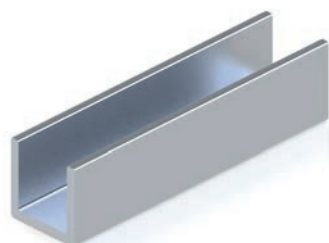

A ALUMICONTE reserva-se o direito de fazer modificações em qualquer informação escrita neste catálogo sem aviso prévio. Os desenhos aqui contidos possuem medidas teóricas de massa e tolerâncias dimensionais de acordo com a ABNT NBR-8116, podendo haver variações dessas informações no produto final.

# DIVERSOS

Aqui você encontra uma seleção de perfis versáteis, com diferentes modelos que atendem a uma ampla variedade de aplicações.



Perfil Quadro Espelho  
Cód.: DES-2261

## DES-2261

Perfil Quadro de Espelho

0,403 Kg/m

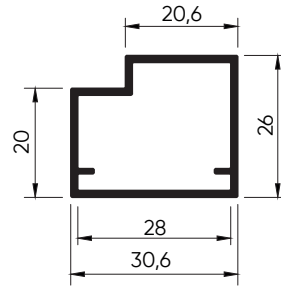

CORTE



MONTAGEM COM ESQUADRETA



RECEBE LED



### Montagem Perfil Quadro de Espelho

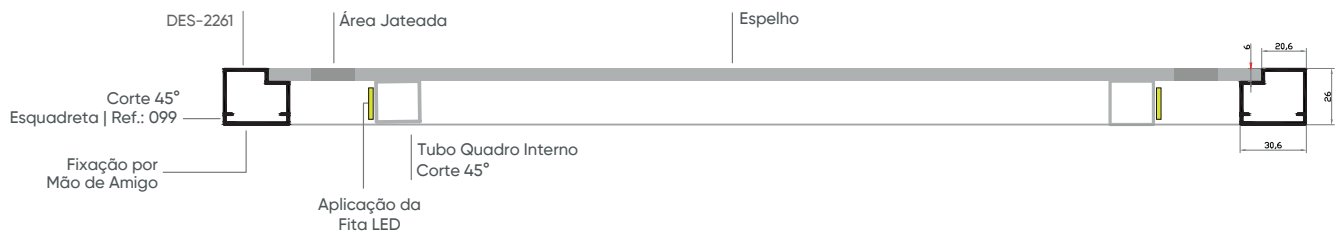

## DES-161

Perfil Cabideiro

0,248 Kg/m

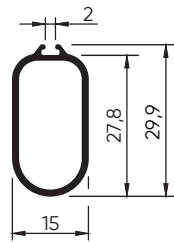

## DES-1899

Perfil Cabideiro

0,291 Kg/m

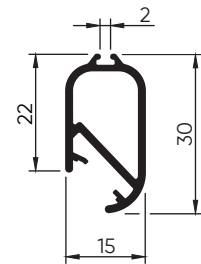

## DES-052

Tubo Cabideiro Redondo

0,242 Kg/m

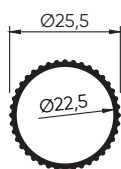

## DES-163

Cabideiro Oblongo

0,178 Kg/m

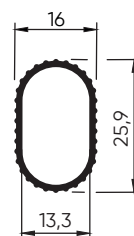

## DES-271

Cabideiro Oblongo

0,207 Kg/m

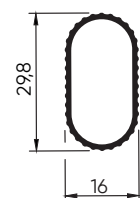

### DES-181

Perfil I Paralelo Nível de Alumínio

0,315 Kg/m

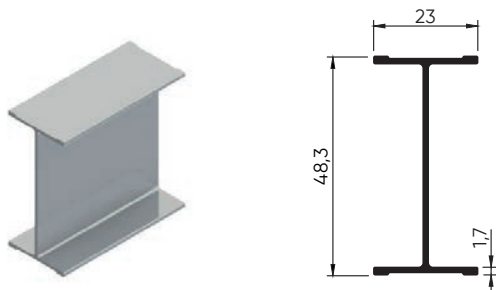

### DES-1443

Borda Luminária LED

0,152 Kg/m

Ponteira disponível

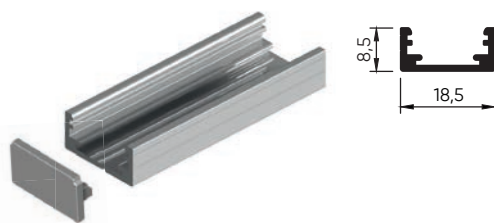

### DES-1444

Borda Luminária LED

0,147 Kg/m

Ponteira disponível

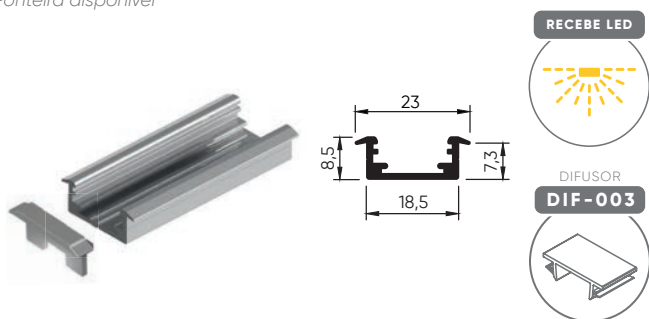

### DES-1816

Perfil Borda LED

0,141 Kg/m

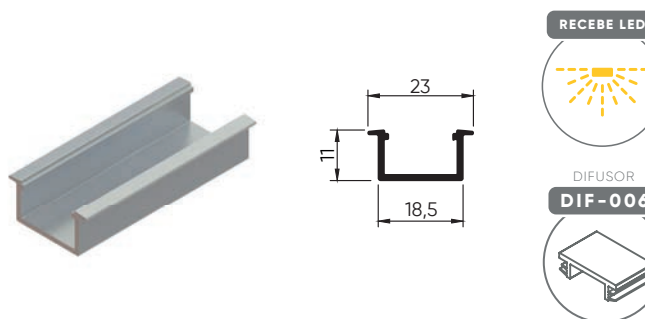

### DES-1458

Cantoneira 19x19mm

0,117 Kg/m

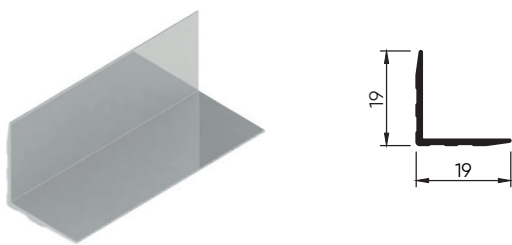

### DES-093

Guia de Encaixe Vidro 10mm

0,227 Kg/m

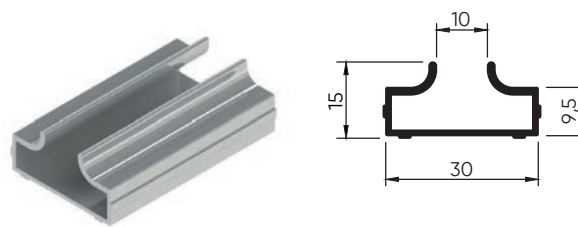

### DES-880

Tubo Quadrado 38mm c/ Olhal Fixação

0,928 Kg/m

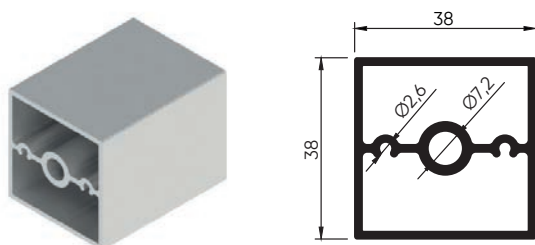

### DES-1515

Trilho Mão de Amigo

0,080 Kg/m

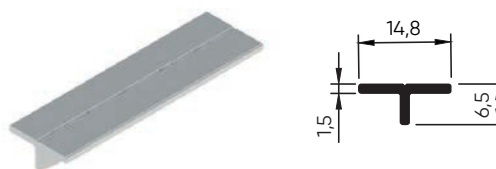

A ALUMICONTE reserva-se o direito de fazer modificações em qualquer informação escrita neste catálogo sem aviso prévio. Os desenhos aqui contidos possuem medidas teóricas de massa e tolerâncias dimensionais de acordo com a ABNT NBR-8116, podendo haver variações dessas informações no produto final.

## DES-1253

Complemento Cava Dupla 49x22,5mm  
0,559 Kg/m

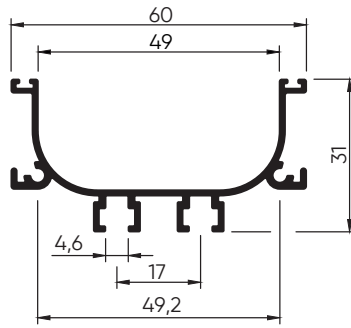

Cantoneira



## DES-1254

Complemento Cava Simples 45x22,5mm  
0,452 Kg/m

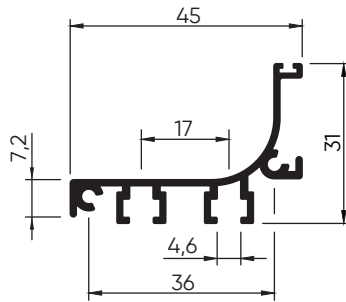
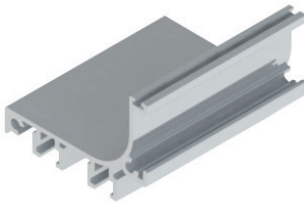

Cantoneira



**Aplicação**  
DES-1253 com cantoneira



**Aplicação**  
DES-1254 com cantoneira

A ALUMICONTE reserva-se o direito de alterar sem aviso prévio. Os desenhos aqui contidos possuem medidas teóricas de massa e tolerâncias dimensionais, podendo haver variações dessas informações no produto final.

Perfil Cava  
Cód.: DES-1253  
e DES-1254

# DES-2259

Rodapé MDF 18 mm

0,358 Kg/m

Ponteira disponível

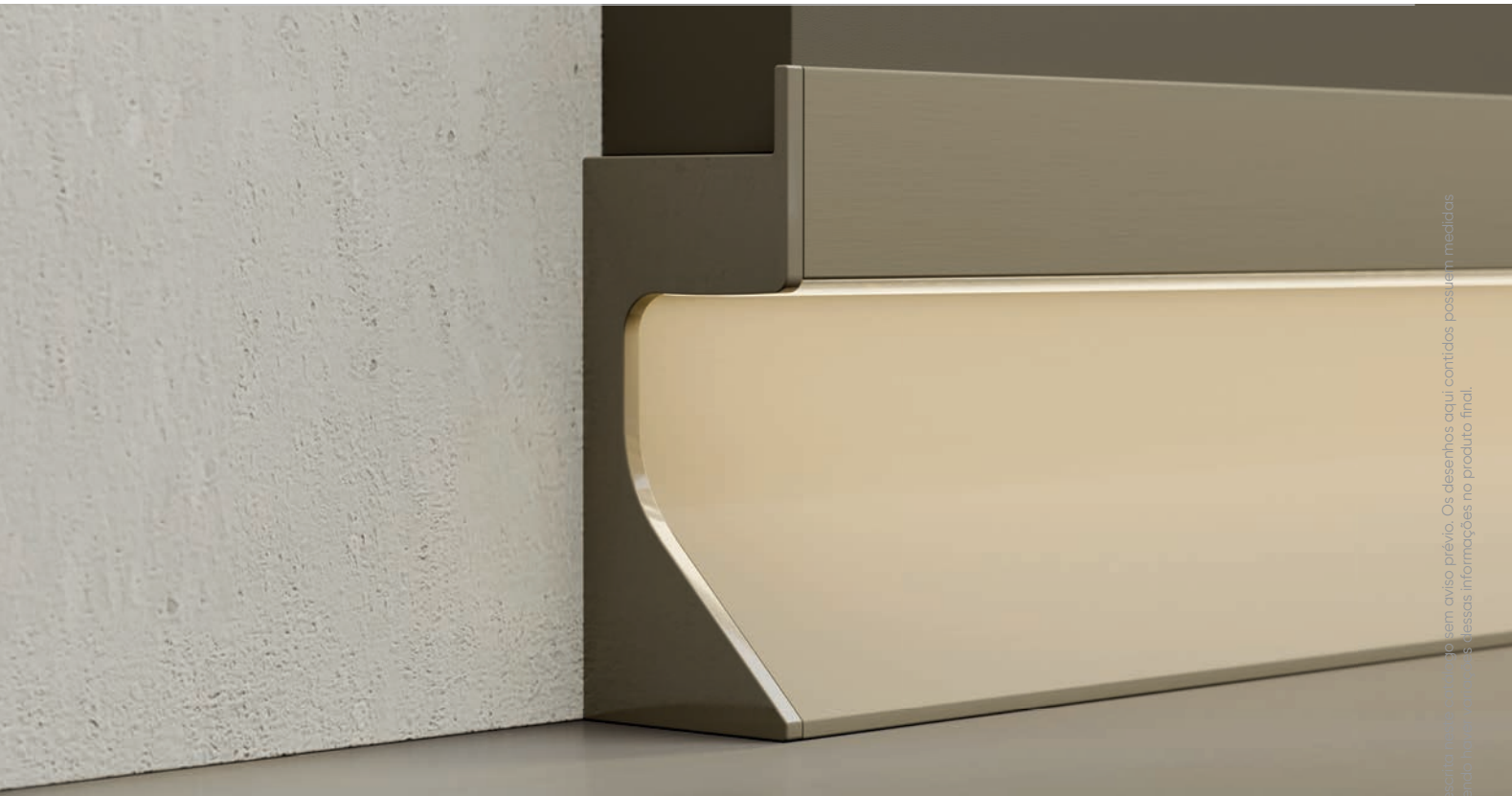
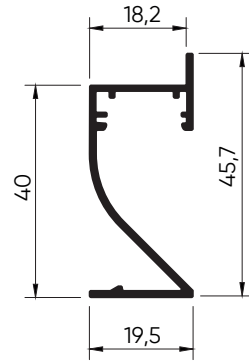
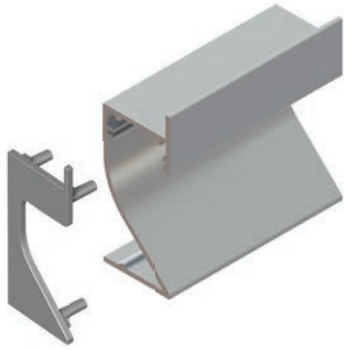

A ALUMICONTE reserva-se o direito de fazer modificações em qualquer informação escrita neste catálogo sem aviso prévio. Os desenhos aqui contidos possuem medidas teóricas de massa e tolerâncias dimensionais de acordo com a ABNT NBR-8116, podendo haver variações. Essas informações são apenas para fins informativos.

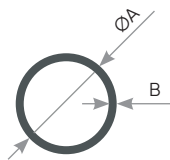

### Tubos Redondos

CÓDIGO	DIÂMETRO ØA	ESPESSURA B	PESO
<b>DES-1455</b>	Ø 9,5 mm (3/8")	1,2 mm	0,089 Kg/m
<b>DES-289</b>	Ø 12,7 mm (1/2")	1,6 mm	0,150 Kg/m
<b>BXT-497</b>	Ø 19,05 mm (1/3")	1,3 mm	0,199 Kg/m
<b>BXT-500</b>	Ø 25,4 mm (1")	1,3 mm	0,271 Kg/m
<b>BXT-499</b>	Ø 38,1 mm (1 1/2")	1,3 mm	0,396 Kg/m
<b>DES-097</b>	Ø 50,8 mm (2")	1,2 mm	0,507 Kg/m

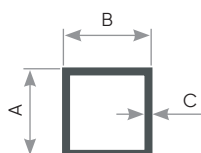

### Tubos Quadrados | Retangulares

CÓDIGO	TAMANHO A	TAMANHO B	ESPESSURA C	PESO
<b>DES-1923</b>	9,5 mm (3/8")	9,5 mm (3/8")	1,2 mm	0,110 Kg/m
<b>DES-602</b>	12,7 mm (1/2")	12,7 mm (1/2")	1,5 mm	0,182 Kg/m
<b>DES-998</b>	12,7 mm (1/2")	12,7 mm (1/2")	1,2 mm	0,148 Kg/m
<b>DES-1040</b>	15 mm	15 mm	2 mm	0,282 Kg/m
<b>DES-256</b>	25,4 mm (1")	25,4 mm (1")	1,6 mm	0,398 Kg/m
<b>DES-386</b>	38,1 mm (1 1/2")	38,1 mm (1 1/2")	1,3 mm	0,519 Kg/m
<b>DES-255</b>	38,1 mm (1 1/2")	38,1 mm (1 1/2")	2 mm	0,783 Kg/m
<b>DES-1026</b>	40 mm	40 mm	1,3 mm	0,545 Kg/m
<b>DES-496</b>	13 mm	50 mm	1,3 mm	0,405 Kg/m
<b>DES-1297</b>	40 mm	23,6 mm	1,5 mm	0,500 Kg/m
<b>DES-1016</b>	20 mm	13,6 mm	1,4 mm	0,232 Kg/m

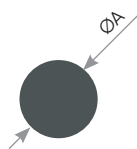

### Vergalhões

CÓDIGO	DIÂMETRO ØA	PESO
<b>DES-677</b>	Ø 11,1 mm (7/16")	0,263 Kg/m
<b>DES-678</b>	Ø 12,7 mm (1/2")	0,343 Kg/m

A ALUMICONTE reserva-se o direito de fazer modificações em qualquer informação escrita neste catálogo sem aviso prévio. Os desenhos aqui contidos possuem medidas teóricas de massa e tolerâncias dimensionais de acordo com a ABNT NBR-8116, podendo haver variações dessas informações no produto final.

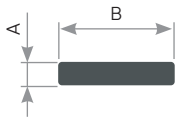

## Barras Chatas

CÓDIGO	TAMANHO A	TAMANHO B	PESO
<b>DES-319</b>	3 mm	16 mm	0,126 Kg/m
<b>DES-267</b>	3,18 mm	19,05 mm	0,164 Kg/m
<b>BXT-485</b>	2,5 mm	19 mm	0,130 Kg/m
<b>BXT-483</b>	4 mm	19 mm	0,207 Kg/m
<b>BXT-484</b>	4,5 mm	23 mm	0,284 Kg/m
<b>DES-086</b>	3 mm	25 mm	0,203 Kg/m
<b>DES-087</b>	3 mm	35 mm	0,284 Kg/m
<b>DES-873</b>	4,8 mm	38,1 mm	0,491 Kg/m
<b>DES-742</b>	6,4 mm	43 mm	0,740 Kg/m
<b>DES-140</b>	9,5 mm	44,5 mm	1,145 Kg/m

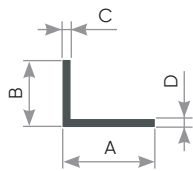

## Cantoneiras

CÓDIGO	TAM. A	TAM. B	TAM. C	TAM. D	PESO
<b>ALU-043</b>	46 mm	27,5 mm	2,5 mm	2,5 mm	0,481 Kg/m
<b>ALU-044</b>	46 mm	37,5 mm	4 mm	4 mm	0,893 Kg/m
<b>BXT-498</b>	50,8 mm	50,8 mm	2 mm	2 mm	0,485 Kg/m
<b>DES-151</b>	12 mm	8 mm	1 mm	1,5 mm	0,064 Kg/m
<b>DES-243</b>	15,8 mm	15,8 mm	1,3 mm	1,3 mm	0,106 Kg/m
<b>DES-244</b>	19 mm	19 mm	1,3 mm	1,3 mm	0,129 Kg/m

A ALUMICONTE reserva-se o direito de fazer modificações em qualquer informação escrita neste catálogo sem aviso prévio. Os desenhos aqui contidos possuem medidas teóricas de massa e tolerâncias dimensionais de acordo com a ABNT NBR-8116, podendo haver variações dessas informações no produto final.



COMPROMISSO COM A QUALIDADE E O MEIO AMBIENTE, CERTIFICADOS.



Confira nosso site escaneando o QR Code acima.



# ALUMICONTE

