



Linha Moveleira

CATÁLOGO GERAL

 **ALUMICONTE**



ALUMICONTE

5.^a EDIÇÃO • 2026 • REVISÃO 02

Você encontra a versão atualizada deste catálogo
em nosso site, www.alumicone.com.br



Alumicone

alumicone@alumicone.com.br

R. Conde de Porto Alegre, 1000 | Vila Flores | Rio Grande do Sul | Brasil

A ÚNICA
EMPRESA
NO **BRASIL**
A PRODUZIR
COMPONENTES,
PERFIS E
PERSIANAS

Fundada em 1988, a Alumiconte conta com amplo portfólio de componentes e persianas para esquadrias, além de perfis para indústria moveleira e construção civil, dispondo de processo próprio de anodização, pintura eletrostática e sublimação para acabamento dos produtos.

Destaca-se pela qualidade dos produtos e serviços prestados, resultado da dedicação em todas as etapas do processo produtivo, e pela assistência técnica especializada que oferece aos clientes, **elaborando soluções** que se adaptam perfeitamente aos projetos.



São mais de:

37 anos
de experiência no setor

4.500
itens

25.000m²
de área fabril



RESPEITO AO MEIO AMBIENTE

A empresa atende às diretrizes e os compromissos ambientais gerados nas esferas municipal, estadual e federal, atendendo os requisitos da Norma Internacional **ISO 14001:2015 - Gestão Ambiental**, na qual é certificada. Implantou em 1999 uma estação de tratamento de efluentes líquidos industriais com área construída de 1.158m², além de:

- 1.** Priorizar a redução na geração de resíduos.
- 2.** Implantar técnicas de tratamento e disposição com baixo consumo de energia e espaço físico.
- 3.** Sempre que possível optar pelo reúso e/ou pela reciclagem.
- 4.** Operar o processo produtivo maximizando as tecnologias limpas.
- 5.** Gerenciar os resíduos, preservando assim, a qualidade ambiental e socioeconômica da comunidade na qual estamos inseridos.



COMPROMISSO TOTAL COM A QUALIDADE

São premissas básicas da **Alumiconte** atuar na melhoria contínua de nossos produtos e processos, atendendo os requisitos da norma Internacional **ISO 9001:2015 - Gestão da Qualidade**, na qual é certificada, entre outras normas da ABNT - Associação Brasileira de Normas Técnicas, sempre que aplicáveis, visando o atendimento das necessidades e expectativas dos nossos clientes e partes interessadas, além de estimular, motivar e capacitar os colaboradores a participarem e se comprometerem com os **Programas de Qualidade** em todos os níveis do processo, garantindo assim, produtos com alto padrão de qualidade e a satisfação dos clientes.

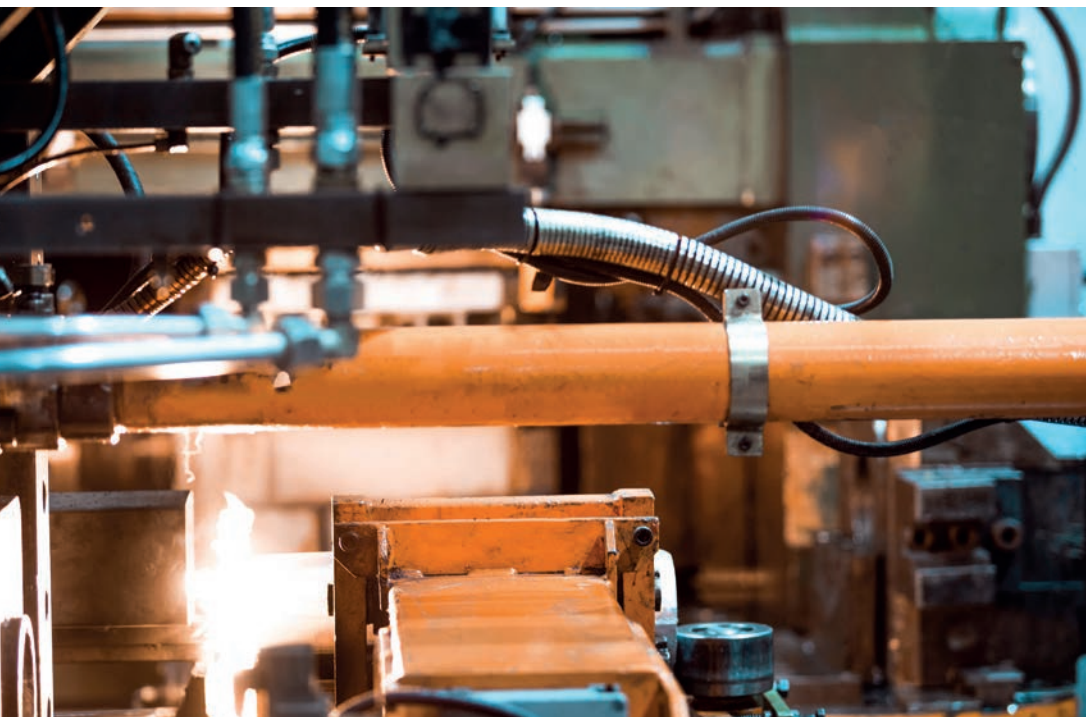



EXTRUSÃO DE ALUMÍNIO

A extrusão é um processo de produção de componentes mecânicos de forma semicontínua, no qual o alumínio é forçado através de uma matriz, adquirindo assim a forma predeterminada de acordo com a necessidade. Perfis de alumínio são utilizados nos ramos de construção civil, indústria naval, aeroespacial, automobilística e moveleira.

Na Alomiconte, contamos com 3 grandes extrusoras de alumínio, voltados a atender a construção civil, setor moveleiro e industrial.

CONSTRUÇÃO CIVIL

Perfis voltados para a produção de esquadrias, oferecemos ampla gama de produtos, atendendo de forma eficiente às necessidades do serralheiro, entregando alto padrão estético, de qualidade e funcionalidade.

INDÚSTRIA MOVELEIRA

Em nosso portfólio de itens voltados para indústria moveleira, você encontra mais de 600 produtos em linha, que atendem a inúmeras formas e aplicações.

PERFIS PERSONALIZADOS

Dispomos de setor de engenharia focado na busca pela solução ideal para cada projeto, produzindo perfis personalizados, de acordo com o design e necessidade do cliente.



ESCOVADO

O alumínio anodizado e escovado da Alumaticonte veio para agregar ainda mais requinte e diferenciação aos seus ambientes.

Antes de ser anodizado, o perfil é submetido ao processo de escovação, que confere ao produto uma superfície com textura elegante e sofisticada.

CORES

Bronze 1003	Inox
Bronze 1002	Preto
Bronze 1001	Fosco



JATEAMENTO

A Alumaticonte conta com um grande diferencial no mercado quando o assunto é alumínio jateado, pois o nosso processo é mecânico, ou seja, acontece a partir do contato entre microesferas e o perfil, resultando em uma superfície de aspecto aveludado e sem quaisquer marcas.

A BASE PERFEITA PARA POSTERIOR ANODIZAÇÃO.
Juntos, transformam o alumínio em um elemento essencial para o design do projeto.



ANODIZAÇÃO

A anodização é um processo eletroquímico que transforma a superfície do alumínio em óxido de alumínio, aumentando sua resistência à corrosão e proporcionando um acabamento estético singular. Variações de tonalidade dentro de um mesmo padrão são naturais devido às variáveis do processo.

Este é um dos processos mais utilizados em perfis para o setor moveleiro, que ganha ainda mais beleza quando combinado à escovação ou jateamento.

CORES

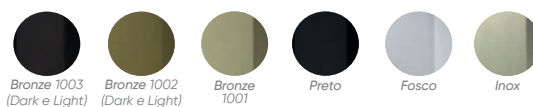

PINTURA ELETROSTÁTICA

Perfeição de cobertura e acabamento são diferenciais da pintura eletrostática, além da resistência à abrasão e corrosão, bem como sua durabilidade perante exposição à intempéries (raios solares, calor, frio e umidade).

Este processo confere ao produto uma superfície lisa e de fácil higienização, combinados à alta durabilidade e aspecto impecável.

CORES

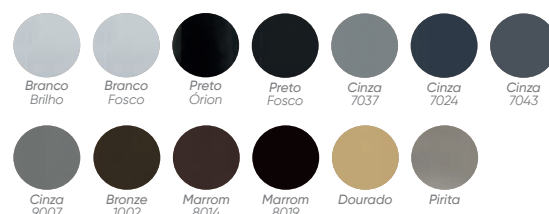

Microtexturizados



Obs.: devido à impressão, podem ocorrer variações de tonalidade entre as amostras de cores do catálogo e produto físico.



ALUMICONTE **MADLOR**

A Alumiconte **Madlor** é uma nova coleção de acabamentos amadeirados, com um processo de **sublimação** completo realizado na Alumiconte.

- Único sistema no mundo a oferecer **10 anos de garantia** na combinação de base + filme, além de contar com certificações Qualicoat e Qualideco.
- Conta com **Test in Flórida**, que garante a eficiência do acabamento.
- Tinta à base de **PU**, a mais eficiente do mercado para processo de sublimação.
- Acabamento **perfeito**, abrangendo todas as regiões da geometria do perfil.
- Variedade de acabamentos para todos os Perfis de Construção Civil e Moveleiro da Alumiconte.

Uma nova proposta que irá trazer mais beleza e sofisticação aos seus projetos.



Confira as cores disponíveis em nosso catálogo:



Madlor Bambu Dourado



Madlor Bétula Marfim

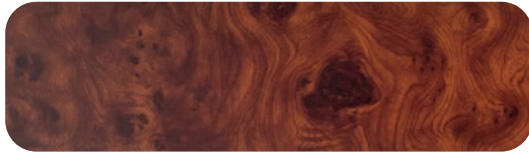

Madlor Briar Marrom



Madlor Carvalho Branco



Madlor Carvalho Louro



Madlor Carvalho Marrom



Madlor Carvalho Verde



Madlor Castanha Café



Madlor Castanha Dourada



Madlor Castanha Sépia

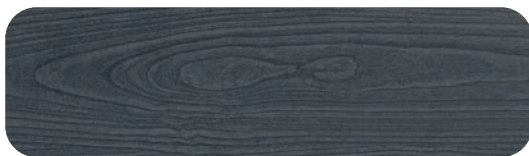

Madlor Cerejeira Cinza



Madlor Cerejeira Marrom



Madlor Cerejeira Negra



Madlor Mogno Carmim

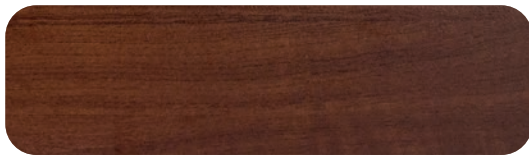

Madlor Mogno Marrom



Madlor Pinus Dourado

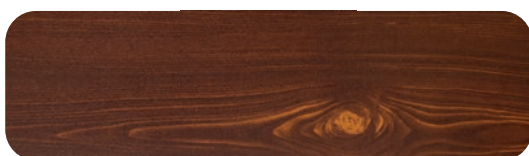

Madlor Pinus Marrom

Obs.: devido à impressão, podem ocorrer variações de tonalidade entre as amostras de cores do catálogo e produto físico.

IMPORTANTE: Os acabamentos sublimados são indicados para as ligas de alumínio 6060 e 6063. Para outras ligas, é necessário realizar testes prévios para validação da aplicação.

REFFINE

CANETA CORRETIVA



A caneta Reffine da Alumiconte foi desenvolvida para retocar marcas e arranhões nas bordas e cantos de peças, refinando o acabamento da esquadria de forma prática e rápida.

Além disso, ela é ideal para realizar o selamento no corte do perfil e bordas expostas. O resultado é um visual uniforme, e grande redução na perda de alumínio por pequenas avarias!



CORES DISPONÍVEIS:

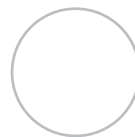

Branco

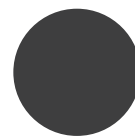

Preto

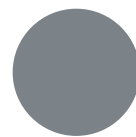

Cinza
RAL 7037



Saiba mais sobre a caneta Reffine acessando o QR Code ao lado.

ÍNDICE POR MODELO

Perfil Puxador Oculto

DES-173..... 16	DES-404..... 16	DES-1270..... 17	DES-1431..... 17
DES-224..... 17	DES-933..... 17	DES-1404..... 17	DES-1432..... 17
DES-345..... 16	DES-1011..... 16	DES-1405..... 17	

Perfil Puxador Oculto com Espiga

DES-022..... 18	DES-094..... 18	DES-1272..... 18
-----------------	-----------------	------------------

Perfil Puxador Testeira com Espiga

DES-622..... 19	DES-623..... 19	DES-1273..... 19	DES-1696..... 19	DES-2167..... 19
-----------------	-----------------	------------------	------------------	------------------

Perfil Puxador Gola

DES-009..... 20	DES-202..... 20	DES-270..... 20	DES-385..... 22	DES-1400..... 21
DES-074..... 22	DES-212..... 21	DES-275..... 21	DES-620..... 22	DES-1401..... 21
DES-089..... 22	DES-213..... 21	DES-284..... 21	DES-621..... 22	
DES-197..... 21	DES-214..... 20	DES-312..... 21	DES-949..... 22	
DES-201..... 22	DES-264..... 20	DES-339..... 20	DES-960..... 20	

Perfil Puxador Gola com Espiga

DES-142..... 23	DES-238..... 23	DES-314..... 23	DES-611..... 23
-----------------	-----------------	-----------------	-----------------

Perfil Puxador de Correr MDF

DES-102..... 24	DES-162..... 24	DES-222..... 24	DES-291..... 24	DES-307..... 24
-----------------	-----------------	-----------------	-----------------	-----------------

Perfil Quadro de Vidro

DES-001.....37	DES-187..... 35	DES-721.....37	DES-1075.....33	DES-1414..... 41
DES-002..... 38	DES-198.....30	DES-730..... 30	DES-1093..... 29	DES-1419..... 32
DES-007.....37	DES-204.....30	DES-856..... 30	DES-1094..... 29	DES-1451..... 41
DES-010..... 38	DES-225..... 28	DES-856..... 36	DES-1225.....27	DES-1489..... 34
DES-011..... 35	DES-226..... 28	DES-875.....37	DES-1226.....27	DES-1490..... 34
DES-012..... 35	DES-227..... 28	DES-877..... 30	DES-1227.....27	DES-1491..... 34
DES-014..... 36	DES-232.....33	DES-897..... 30	DES-1228.....27	DES-1492..... 34
DES-015..... 42	DES-233.....33	DES-902.....39	DES-1250..... 37	DES-1612.....39
DES-016.....39	DES-247..... 36	DES-912.....27	DES-1264..... 31	DES-1697.....33
DES-017..... 42	DES-279..... 36	DES-912..... 28	DES-1265..... 35	DES-1789..... 32
DES-019..... 42	DES-282..... 30	DES-929.....37	DES-1268..... 31	DES-1934.....39
DES-026..... 35	DES-297.....39	DES-950..... 30	DES-1271..... 28	DES-2074..... 40
DES-060.....39	DES-311..... 31	DES-951..... 36	DES-1279.....39	DES-2075..... 40
DES-062..... 38	DES-313..... 35	DES-952..... 36	DES-1291..... 42	DES-2192..... 32
DES-073..... 41	DES-318.....37	DES-953..... 41	DES-1321..... 41	DES-2193..... 32
DES-077..... 36	DES-320..... 35	DES-1012..... 35	DES-1326..... 38	DES-2349.....33
DES-078..... 36	DES-370..... 31	DES-1016..... 31	DES-1328..... 38	DES-2350..... 34
DES-084.....37	DES-530..... 38	DES-1042..... 29	DES-1402..... 31	DES-2351..... 34
DES-133..... 38	DES-550..... 38	DES-1043..... 29	DES-1403..... 31	DES-2425..... 41
DES-147..... 41	DES-691..... 32	DES-1073.....33	DES-1407..... 34	DES-3098..... 41
DES-178..... 42	DES-692..... 32	DES-1074.....33	DES-1408..... 34	

ÍNDICE POR MODELO

Perfil **Puxador de Encaixe**

DES-043..... 43	DES-395 45	DES-1251..... 43	DES-1332..... 45	DES-2347 46
DES-112..... 44	DES-519 43	DES-1278 44	DES-1420 44	DES-2348..... 46
DES-148..... 44	DES-842..... 44	DES-1299..... 45	DES-1613..... 43	DES-2822 46
DES-203..... 44	DES-901..... 45	DES-1319..... 45	DES-1614..... 43	DES-2892..... 46
DES-239 43	DES-909..... 44	DES-1324..... 45	DES-2184 43	
DES-296 45	DES-993 44	DES-1329..... 45	DES-2185..... 43	

Alumiconte **Armo**

ARM-062..... 48	ARM-530 48	DES-239 48
ARM-198..... 48	ARM-3047..... 48	DES-395 48

Perfil **Armário com Iluminação Interna**

DES-161..... 50	DES-1478..... 50	DES-1488 50	DES-1492..... 51
DES-600 51	DES-1479..... 50	DES-1489 51	DES-1899..... 50
DES-1016 51	DES-1480 50	DES-1490 51	DES-2428..... 51
DES-1477..... 50	DES-1487..... 50	DES-1491 51	DES-3002 51

Perfil **Painel Movie**

DES-851..... 54	DES-852 54	DES-1298..... 54	DES-1303 54
-----------------	------------------	------------------	-------------------

Alumiconte **Ísis**

CA-0060.....57	DES-1295.....57	DES-1969 60	DES-1998..... 60	RA-005059
CA-0060.....59	DES-1481 58	DES-1970.....59	DES-2076 58	
DES-1293.....57	DES-1482..... 58	DES-1971..... 60	DES-2077 60	
DES-1294.....57	DES-1483..... 58	DES-197259	RA-005057	

Perfil **Porta de Passagem**

DES-036.....62	DES-03962	DES-16762	DES-26162
DES-03762	DES-04462	DES-20062	DES-886.....62

Perfil **Porta de Passagem de Vidro**

BXT-505 64	DES-600 65	DES-1512..... 64	DES-1518 66	DES-1722 64
DES-597..... 65	DES-1302 64	DES-1514 64	DES-1519..... 66	DES-2343..... 65
DES-598 65	DES-1510 64	DES-1516..... 66	DES-1526..... 66	DES-2344 65
DES-599 65	DES-1511 64	DES-1517..... 66	DES-1721..... 64	

Perfil **Porta de Correr**

DES-032..... 70	DES-058.....69	DES-29469	DES-52469	DES-980..... 68
DES-035..... 68	DES-113.....69	DES-309..... 71	DES-601..... 70	DES-992 68
DES-038.....69	DES-155..... 68	DES-315 68	DES-603..... 70	DES-1284 71
DES-041 68	DES-156.....69	DES-344..... 70	DES-820..... 71	DES-1433..... 68
DES-042..... 71	DES-188..... 71	DES-390.....69	DES-843..... 70	DES-1434 70
DES-051..... 70	DES-228 70	DES-511.....69	DES-844..... 71	
DES-055..... 68	DES-28769	DES-51269	DES-944..... 68	

ÍNDICE POR MODELO

Perfil Estrutural para Vidro

DES-25772	DES-260.....72	DES-874.....72	DES-140973	DES-141273
DES-25872	DES-334.....72	DES-93273	DES-141073	DES-141373
DES-25972	DES-40073	DES-130473	DES-141173	DES-144573

Perfil Testeira e Emenda

DES-165.....74	DES-241.....75	DES-596.....74	DES-162075	DES-300576
DES-171.....74	DES-248.....74	DES-61675	DES-2089.....75	DES-300676
DES-205.....74	DES-24974	DES-69475	DES-209075	DES-300776
DES-240.....75	DES-29274	DES-1281.....75	DES-263974	

Perfis Ripados

ALV-2511 82	ALV-2513..... 81	ALV-2582.....79	ALV-258479	DES-1290 81
ALV-2512..... 82	ALV-2518 82	ALV-2583.....79	ALV-2585.....79	

Perfis Trilhos para Esquadria de Madeira

DES-006 83	DES-029 84	DES-034..... 84	DES-164..... 83	DES-876..... 84
DES-027 83	DES-031..... 84	DES-040 84	DES-166 84	
DES-028..... 83	DES-033..... 83	DES-059 83	DES-242 83	

Perfis Diversos

DES-052..... 86	DES-181.....87	DES-1254..... 88	DES-151587	DES-2261 86
DES-093.....87	DES-271 86	DES-144387	DES-1816.....87	
DES-161..... 86	DES-880.....87	DES-144487	DES-1899..... 86	
DES-163..... 86	DES-1253..... 88	DES-145887	DES-2259 89	

Perfis Tubulares | Barras Chatas | Cantoneiras

ALU-043..... 91	BXT-499..... 90	DES-243 91	DES-386 90	DES-998 90
ALU-044..... 91	BXT-500..... 90	DES-244..... 91	DES-496 90	DES-1016 90
BXT-483..... 91	DES-086..... 91	DES-255 90	DES-602..... 90	DES-1026 90
BXT-484 91	DES-087 91	DES-256 90	DES-677 90	DES-1040..... 90
BXT-485 91	DES-097 90	DES-267..... 91	DES-678..... 90	DES-1297 90
BXT-497 90	DES-140 91	DES-289 90	DES-742 91	DES-1455..... 90
BXT-498..... 91	DES-151..... 91	DES-319 91	DES-873 91	DES-1923..... 90

ÍNDICE GERAL

ALU-043.....	91	DES-074.....	22	DES-257.....	72	DES-691.....	32	DES-1270.....	17	DES-1492.....	34
ALU-044.....	91	DES-077.....	36	DES-258.....	72	DES-692.....	32	DES-1271.....	28	DES-1492.....	51
ALV-2511.....	82	DES-078.....	36	DES-259.....	72	DES-694.....	75	DES-1272.....	18	DES-1510.....	64
ALV-2512.....	82	DES-084.....	37	DES-260.....	72	DES-721.....	37	DES-1273.....	19	DES-1511.....	64
ALV-2513.....	81	DES-086.....	91	DES-261.....	62	DES-730.....	30	DES-1278.....	44	DES-1512.....	64
ALV-2518.....	82	DES-087.....	91	DES-264.....	20	DES-742.....	91	DES-1279.....	39	DES-1514.....	64
ALV-2582.....	79	DES-089.....	22	DES-267.....	91	DES-820.....	71	DES-1281.....	75	DES-1515.....	87
ALV-2583.....	79	DES-093.....	87	DES-270.....	20	DES-842.....	44	DES-1284.....	71	DES-1516.....	66
ALV-2584.....	79	DES-094.....	18	DES-271.....	86	DES-843.....	70	DES-1290.....	81	DES-1517.....	66
ALV-2585.....	79	DES-097.....	90	DES-275.....	21	DES-844.....	71	DES-1291.....	42	DES-1518.....	66
ARM-062.....	48	DES-102.....	24	DES-279.....	36	DES-851.....	54	DES-1293.....	57	DES-1519.....	66
ARM-198.....	48	DES-112.....	44	DES-282.....	30	DES-852.....	54	DES-1294.....	57	DES-1526.....	66
ARM-530.....	48	DES-113.....	69	DES-284.....	21	DES-856.....	30	DES-1295.....	57	DES-1612.....	39
ARM-3047.....	48	DES-133.....	38	DES-287.....	69	DES-856.....	36	DES-1297.....	90	DES-1613.....	43
BXT-483.....	91	DES-140.....	91	DES-289.....	90	DES-873.....	91	DES-1298.....	54	DES-1614.....	43
BXT-484.....	91	DES-142.....	23	DES-291.....	24	DES-874.....	72	DES-1299.....	45	DES-1620.....	75
BXT-485.....	91	DES-147.....	41	DES-292.....	74	DES-875.....	37	DES-1302.....	64	DES-1696.....	19
BXT-497.....	90	DES-148.....	44	DES-294.....	69	DES-876.....	84	DES-1303.....	54	DES-1697.....	33
BXT-498.....	91	DES-151.....	91	DES-296.....	45	DES-877.....	30	DES-1304.....	73	DES-1721.....	64
BXT-499.....	90	DES-155.....	68	DES-297.....	39	DES-880.....	87	DES-1319.....	45	DES-1722.....	64
BXT-500.....	90	DES-156.....	69	DES-307.....	24	DES-881.....	25	DES-1321.....	41	DES-1789.....	32
BXT-505.....	64	DES-161.....	50	DES-309.....	71	DES-886.....	62	DES-1324.....	45	DES-1816.....	87
CA-0060.....	57	DES-161.....	86	DES-311.....	31	DES-897.....	30	DES-1326.....	38	DES-1899.....	50
CA-0060.....	59	DES-162.....	24	DES-312.....	21	DES-901.....	45	DES-1328.....	38	DES-1899.....	86
DES-001.....	37	DES-163.....	86	DES-313.....	35	DES-902.....	39	DES-1329.....	45	DES-1923.....	90
DES-002.....	38	DES-164.....	83	DES-314.....	23	DES-909.....	44	DES-1332.....	45	DES-1934.....	39
DES-006.....	83	DES-165.....	74	DES-315.....	68	DES-912.....	27	DES-1400.....	21	DES-1969.....	60
DES-007.....	37	DES-166.....	84	DES-318.....	37	DES-912.....	28	DES-1401.....	21	DES-1970.....	59
DES-009.....	20	DES-167.....	62	DES-319.....	91	DES-929.....	37	DES-1402.....	31	DES-1971.....	60
DES-010.....	38	DES-171.....	74	DES-320.....	35	DES-932.....	73	DES-1403.....	31	DES-1972.....	59
DES-011.....	35	DES-173.....	16	DES-334.....	72	DES-933.....	17	DES-1404.....	17	DES-1998.....	60
DES-012.....	35	DES-178.....	42	DES-339.....	20	DES-944.....	68	DES-1405.....	17	DES-2074.....	40
DES-014.....	36	DES-181.....	87	DES-344.....	70	DES-949.....	22	DES-1407.....	34	DES-2075.....	40
DES-015.....	42	DES-187.....	35	DES-345.....	16	DES-950.....	30	DES-1408.....	34	DES-2076.....	58
DES-016.....	39	DES-188.....	71	DES-347.....	25	DES-951.....	36	DES-1409.....	73	DES-2077.....	60
DES-017.....	42	DES-197.....	21	DES-370.....	31	DES-952.....	36	DES-1410.....	73	DES-2089.....	75
DES-019.....	42	DES-198.....	30	DES-385.....	22	DES-953.....	41	DES-1411.....	73	DES-2090.....	75
DES-022.....	18	DES-200.....	62	DES-386.....	90	DES-960.....	20	DES-1412.....	73	DES-2167.....	19
DES-026.....	35	DES-201.....	22	DES-390.....	69	DES-980.....	68	DES-1413.....	73	DES-2184.....	43
DES-027.....	83	DES-202.....	20	DES-395.....	45	DES-992.....	68	DES-1414.....	41	DES-2185.....	43
DES-028.....	83	DES-203.....	44	DES-395.....	48	DES-993.....	44	DES-1419.....	32	DES-2192.....	32
DES-029.....	84	DES-204.....	30	DES-400.....	73	DES-998.....	90	DES-1420.....	44	DES-2193.....	32
DES-031.....	84	DES-205.....	74	DES-404.....	16	DES-1011.....	16	DES-1431.....	17	DES-2259.....	89
DES-032.....	70	DES-212.....	21	DES-496.....	90	DES-1012.....	35	DES-1432.....	17	DES-2261.....	86
DES-033.....	83	DES-213.....	21	DES-511.....	69	DES-1016.....	31	DES-1433.....	68	DES-2343.....	65
DES-034.....	84	DES-214.....	20	DES-512.....	69	DES-1016.....	51	DES-1434.....	70	DES-2344.....	65
DES-035.....	68	DES-222.....	24	DES-519.....	43	DES-1016.....	90	DES-1443.....	87	DES-2347.....	46
DES-036.....	62	DES-224.....	17	DES-524.....	69	DES-1026.....	90	DES-1444.....	87	DES-2348.....	46
DES-037.....	62	DES-225.....	28	DES-530.....	38	DES-1040.....	90	DES-1445.....	73	DES-2349.....	33
DES-038.....	69	DES-226.....	28	DES-550.....	38	DES-1042.....	29	DES-1451.....	41	DES-2350.....	34
DES-039.....	62	DES-227.....	28	DES-596.....	74	DES-1043.....	29	DES-1455.....	90	DES-2351.....	34
DES-040.....	84	DES-228.....	70	DES-597.....	65	DES-1073.....	33	DES-1458.....	87	DES-2425.....	41
DES-041.....	68	DES-232.....	33	DES-598.....	65	DES-1074.....	33	DES-1477.....	50	DES-2428.....	51
DES-042.....	71	DES-233.....	33	DES-599.....	65	DES-1075.....	33	DES-1478.....	50	DES-2639.....	74
DES-043.....	43	DES-238.....	23	DES-600.....	51	DES-1093.....	29	DES-1479.....	50	DES-2822.....	46
DES-044.....	62	DES-239.....	43	DES-600.....	65	DES-1094.....	29	DES-1480.....	50	DES-2892.....	46
DES-046.....	25	DES-239.....	48	DES-601.....	70	DES-1225.....	27	DES-1481.....	58	DES-3002.....	51
DES-051.....	70	DES-240.....	75	DES-602.....	90	DES-1226.....	27	DES-1482.....	58	DES-3005.....	76
DES-052.....	86	DES-241.....	75	DES-603.....	70	DES-1227.....	27	DES-1483.....	58	DES-3006.....	76
DES-055.....	68	DES-242.....	83	DES-611.....	23	DES-1228.....	27	DES-1487.....	50	DES-3007.....	76
DES-058.....	69	DES-243.....	91	DES-616.....	75	DES-1250.....	37	DES-1488.....	50	DES-3098.....	41
DES-059.....	83	DES-244.....	91	DES-620.....	22	DES-1251.....	43	DES-1489.....	34	RA-0050.....	57
DES-060.....	39	DES-247.....	36	DES-621.....	22	DES-1253.....	88	DES-1489.....	51	RA-0050.....	59
DES-062.....	38	DES-248.....	74	DES-622.....	19	DES-1254.....	88	DES-1490.....	34		
DES-063.....	25	DES-249.....	74	DES-623.....	19	DES-1264.....	31	DES-1490.....	51		
DES-064.....	25	DES-255.....	90	DES-677.....	90	DES-1265.....	35	DES-1491.....	34		
DES-073.....	41	DES-256.....	90	DES-678.....	90	DES-1268.....	31	DES-1491.....	51		



PUXADORES

Desenvolvidos para facilitar a abertura e o fechamento de portas e gavetas de móveis em geral, os perfis puxadores aliam funcionalidade, durabilidade e design moderno.

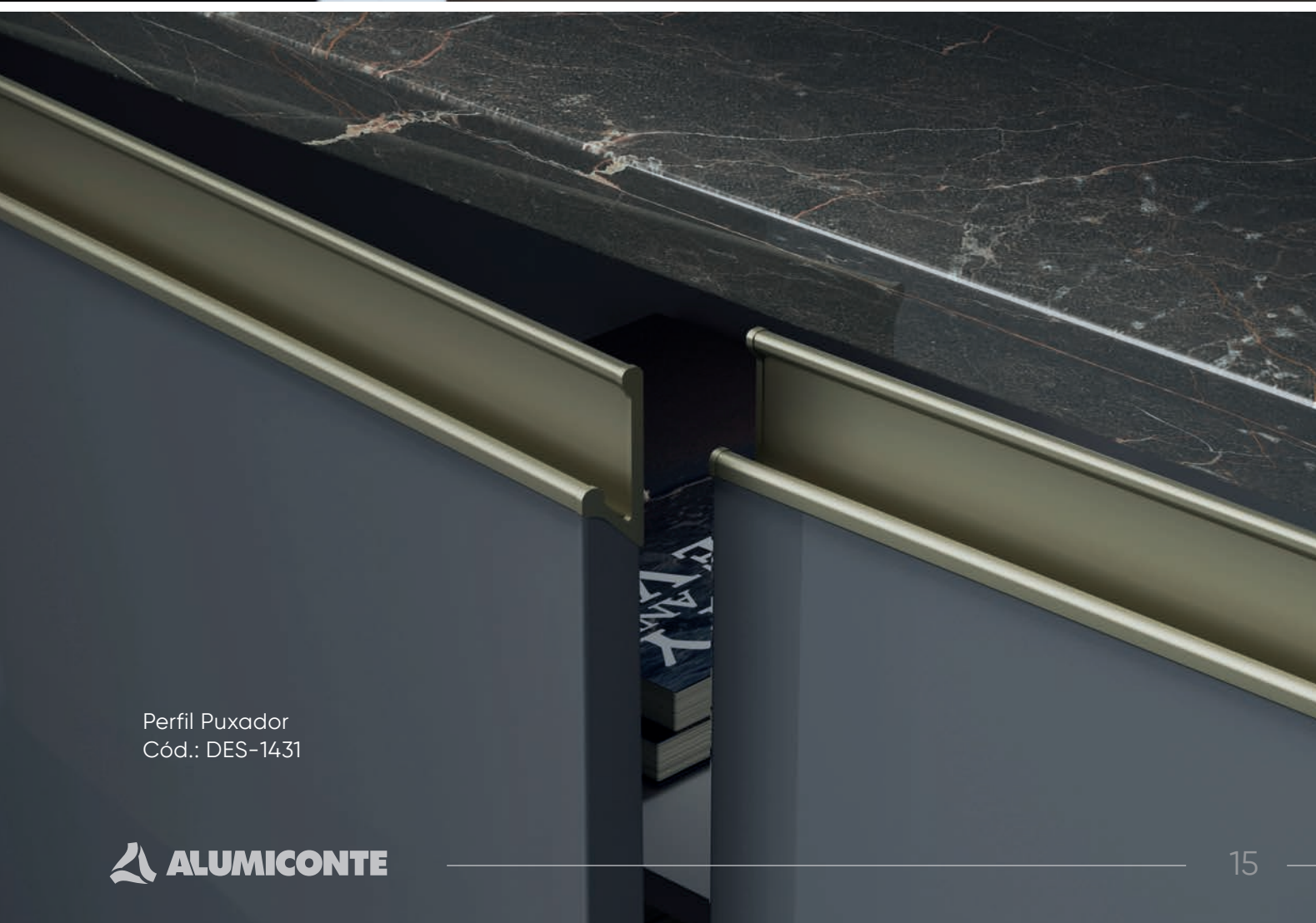

Perfil Puxador
Cód.: DES-1431

DES-173

Puxador de Encaixe | MDF 18 mm
0,437 Kg/m

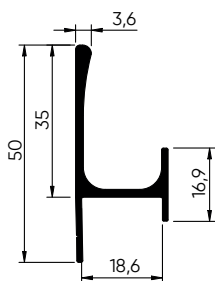

DES-1011

Puxador de Encaixe | MDF 15 mm
0,273 Kg/m

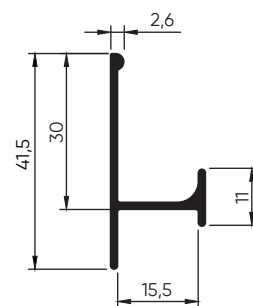

DES-404

Puxador de Encaixe | MDF 18 mm
0,327 Kg/m

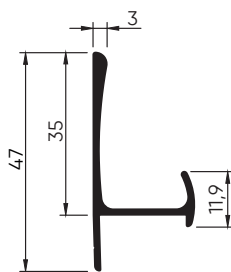

DES-345

Puxador de Encaixe | MDF 15 mm
0,273 Kg/m

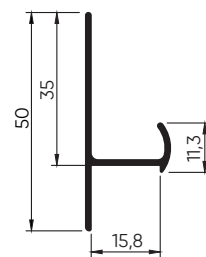

Perfil Puxador
Cód.: DES-1011



DES-224

Puxador de Encaixe | MDF 18 mm
0,378 Kg/m

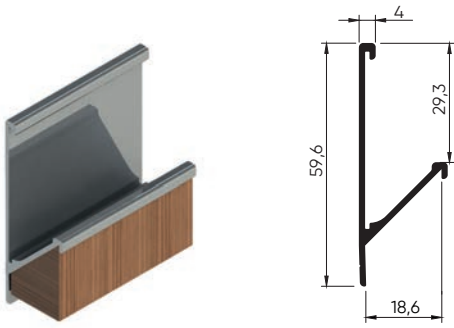

DES-933

Puxador de Encaixe | MDF 15 mm
0,342 Kg/m

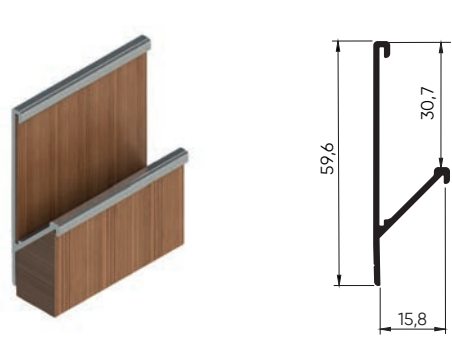

DES-1404

Puxador de Encaixe | MDF 18 mm
0,369 Kg/m

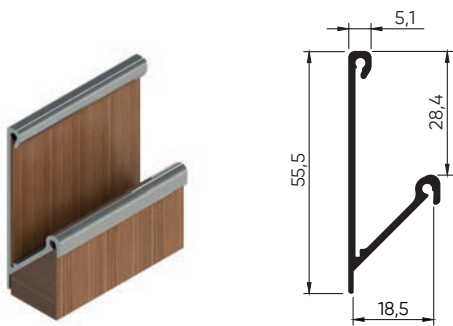

DES-1405

Puxador de Encaixe | MDF 15 mm
0,363 Kg/m



DES-1432

Puxador de Encaixe | MDF 18mm
0,397 Kg/m
Ponteira disponível

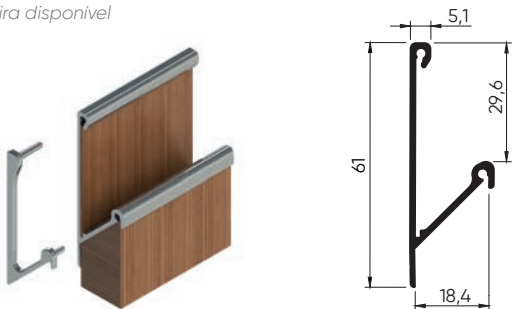

DES-1431

Puxador de Encaixe | MDF 15mm
0,383 Kg/m
Ponteira disponível

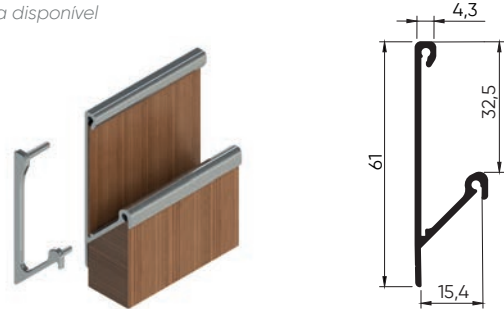

DES-1270

Puxador de Encaixe | MDF 18mm
0,357 Kg/m

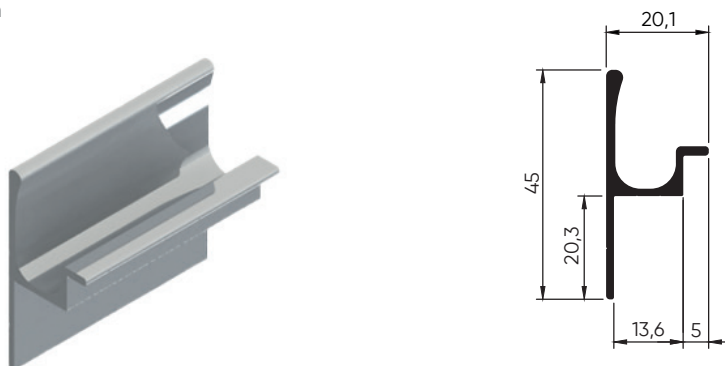

A ALUMICONTE reserva-se o direito de fazer modificações em qualquer informação escrita neste catálogo sem aviso prévio. Os desenhos aqui contidos possuem medidas teóricas de massa e tolerâncias dimensionais de acordo com a ABNT NBR-8116, podendo haver variações dessas informações no produto final.



Perfil Puxador
com Espiga
Cód.: DES-022

DES-022

Puxador de Encaixe com Espiga | MDF 18 mm

0,438 Kg/m

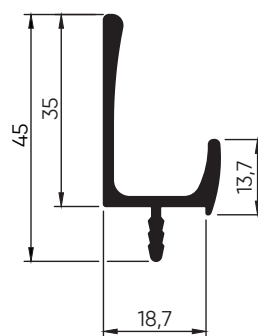

DES-094

Puxador de Encaixe com Espiga | MDF 18 mm

0,392 Kg/m

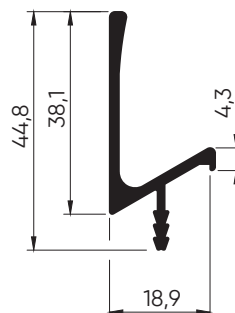

DES-1272

Puxador de Encaixe com Espiga | MDF 18 mm

0,347 Kg/m

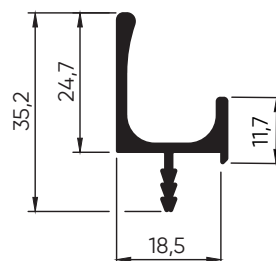
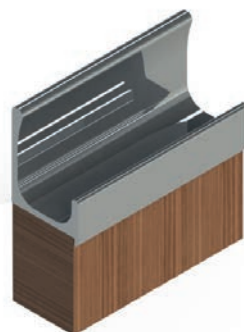

DES-622

Puxador de Encaixe com Espiga | MDF 18 mm
0,505 Kg/m

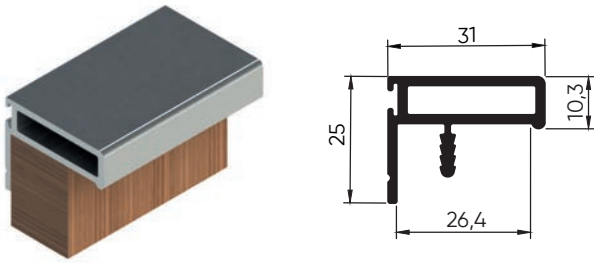

DES-623

Puxador de Encaixe com Espiga | MDF 18 mm
0,745 Kg/m

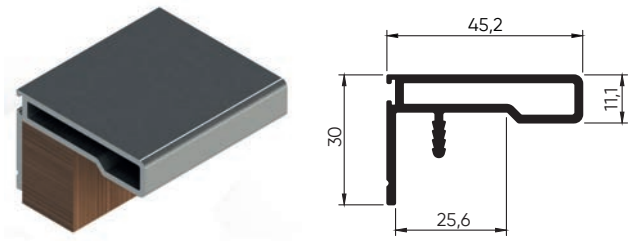

DES-1273

Puxador de Encaixe com Espiga | MDF 18 mm
0,290 Kg/m

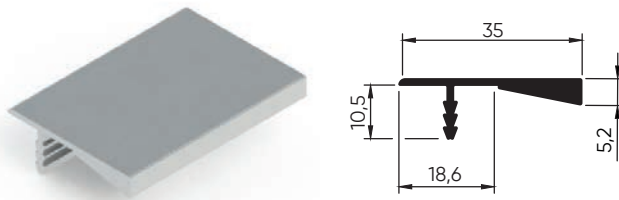

DES-1696

Puxador de Encaixe com Espiga | MDF 18 mm
0,268 Kg/m

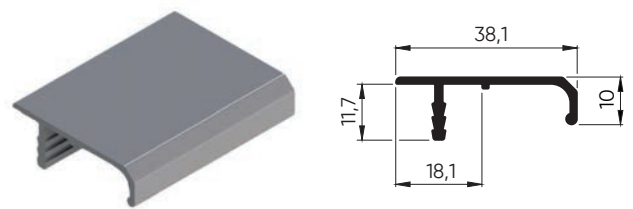

DES-2167

Puxador de Encaixe com Espiga | MDF 18 mm
0,244 Kg/m

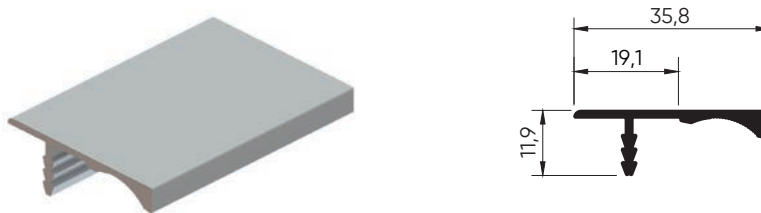

Perfil Puxador
Cód.: DES-2167

DES-009

Puxador de Encaixe | MDF 18 mm
0,336 Kg/m

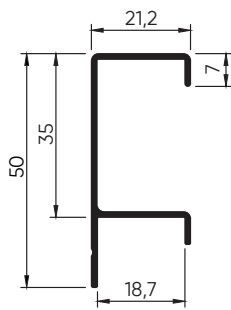

DES-270

Puxador de Encaixe | MDF 15 mm
0,315 Kg/m

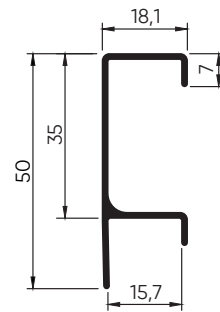

DES-264

Puxador de Encaixe | MDF 18 mm
0,367 Kg/m

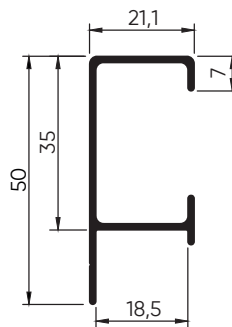

DES-960

Puxador de Encaixe | MDF 18 mm
0,319 Kg/m

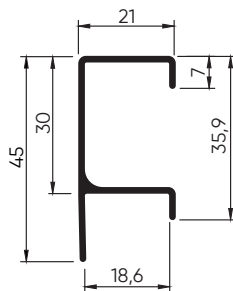

DES-339

Puxador de Encaixe | MDF 15 mm
0,284 Kg/m

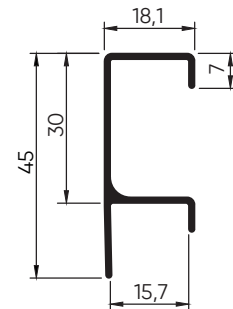

DES-202

Puxador de Encaixe | MDF 18 mm
0,517 Kg/m

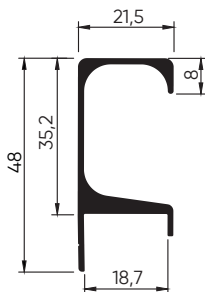

DES-214

Puxador de Encaixe | MDF 15 mm
0,498 Kg/m

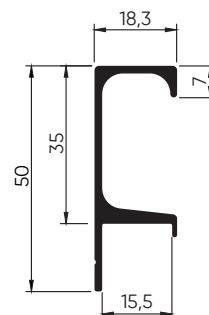
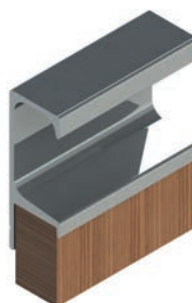

A ALUMICONTE reserva-se o direito de fazer modificações em qualquer informação escrita neste catálogo sem aviso prévio. Os desenhos aqui contidos possuem medidas teóricas de massa e tolerâncias dimensionais de acordo com a ABNT NBR-8116, podendo haver variações dessas informações no produto final.

DES-212

Puxador de Encaixe | MDF 18 mm
0,419 Kg/m

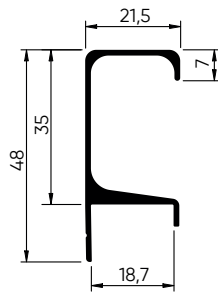

DES-213

Puxador de Encaixe | MDF 15 mm
0,392 Kg/m

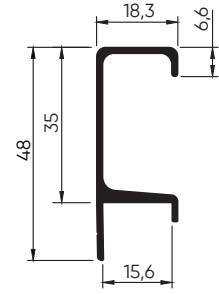

DES-275

Puxador de Encaixe | MDF 18 mm
0,434 Kg/m
Ponteira disponível

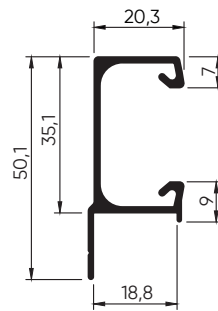

DES-284

Puxador de Encaixe | MDF 15 mm
0,349 Kg/m
Ponteira disponível

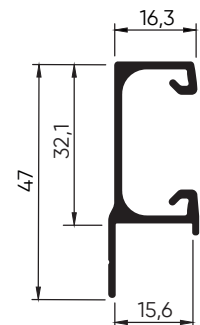

DES-1400

Puxador de Encaixe | MDF 18 mm
0,386 Kg/m
Ponteira disponível

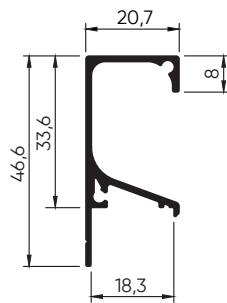

DES-1401

Puxador de Encaixe | MDF 15 mm
0,340 Kg/m
Ponteira disponível

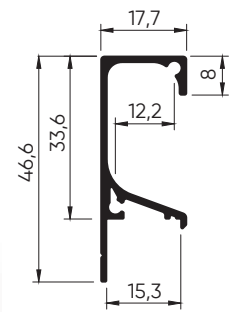
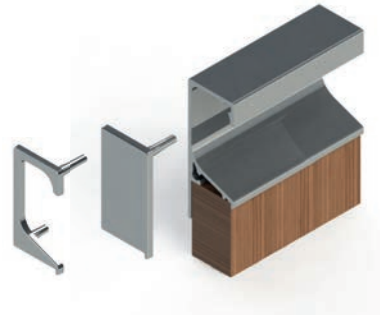

DES-197

Puxador de Encaixe | MDF 18 mm
0,387 Kg/m
Ponteira disponível

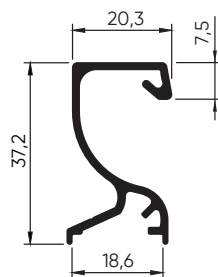
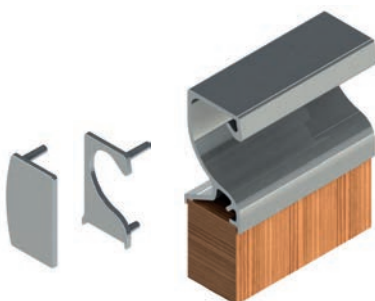

DES-312

Puxador de Encaixe | MDF 15 mm
0,315 Kg/m
Ponteira disponível

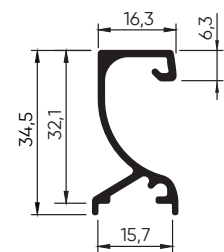
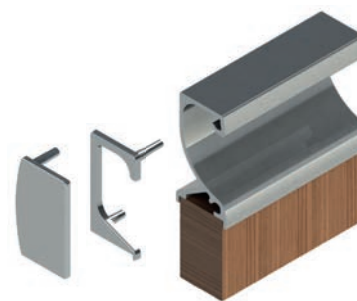

A ALUMICONTE reserva-se o direito de fazer modificações em qualquer informação escrita neste catálogo sem aviso prévio. Os desenhos aqui contidos possuem medidas teóricas de massa e tolerâncias dimensionais de acordo com a ABNT NBR-8116, podendo haver variações dessas informações no produto final.

DES-620

Puxador de Encaixe | MDF 18 mm

0,461 Kg/m

Ponteira disponível

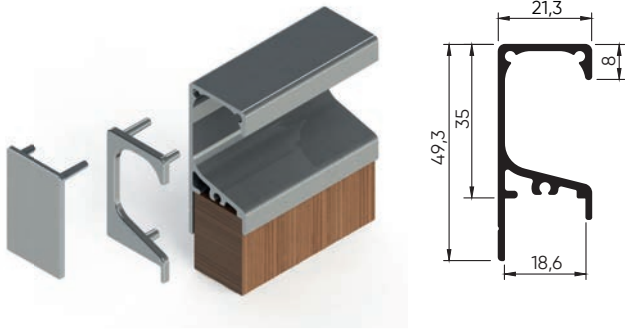

DES-621

Puxador de Encaixe | MDF 15 mm

0,420 Kg/m

Ponteira disponível

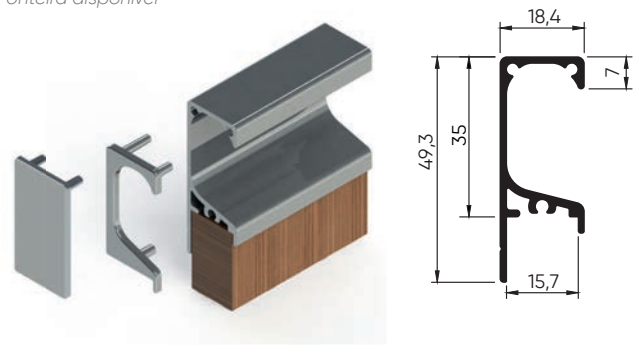

DES-074

Puxador de Encaixe | MDF 18 mm

0,446 Kg/m

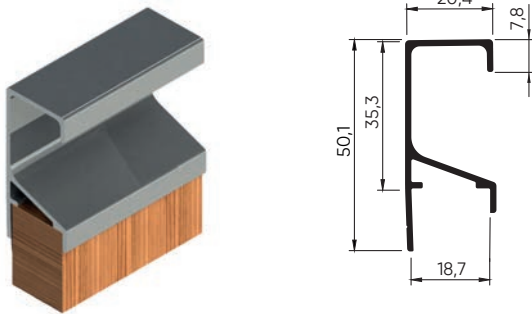

DES-089

Puxador de Encaixe | MDF 18 mm

0,461 Kg/m

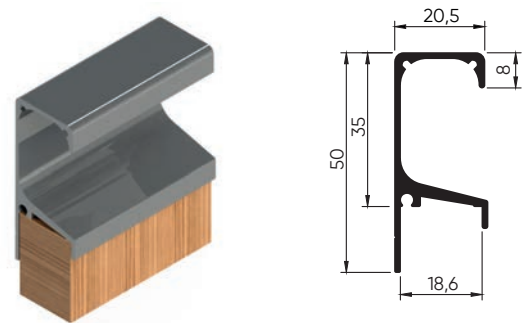

DES-385

Puxador de Encaixe | MDF 18 mm

0,469 Kg/m

Ponteira disponível

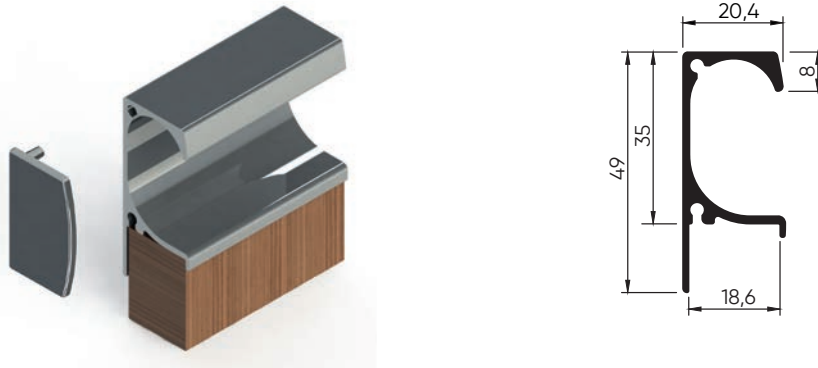

DES-201

Puxador de Encaixe | MDF 18 mm

0,456 Kg/m

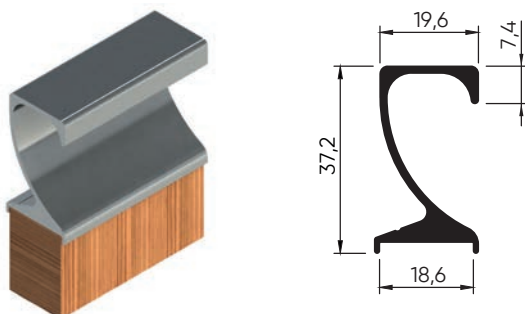

DES-949

Puxador de Encaixe | MDF 18 mm

0,469 Kg/m

Ponteira disponível

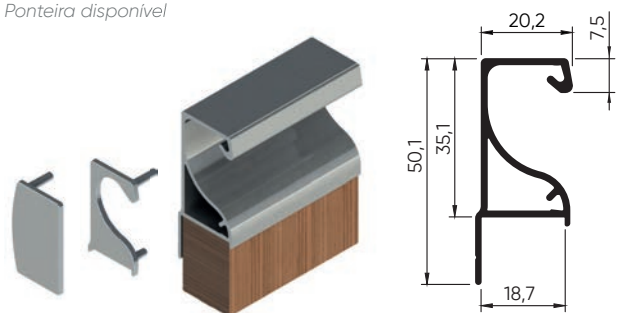

A ALUMICONTE reserva-se o direito de fazer modificações em qualquer informação escrita neste catálogo sem aviso prévio. Os desenhos aqui contidos possuem medidas teóricas de massa e tolerâncias dimensionais de acordo com a ABNT NBR-8116, podendo haver variações dessas informações no produto final.

DES-142

Puxador de Encaixe com Espiga | MDF 18 mm
0,441 Kg/m

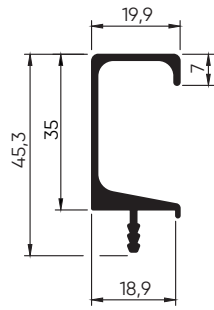
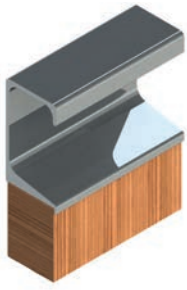

DES-238

Puxador de Encaixe com Espiga | MDF 15 mm
0,377 Kg/m

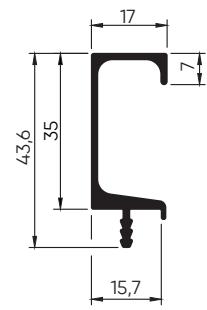

DES-314

Puxador de Encaixe com Espiga | MDF 18 mm
0,457 Kg/m
Ponteira disponível

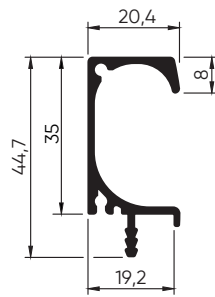

DES-611

Puxador de Encaixe com Espiga | MDF 18 mm
0,437 Kg/m
Ponteira disponível

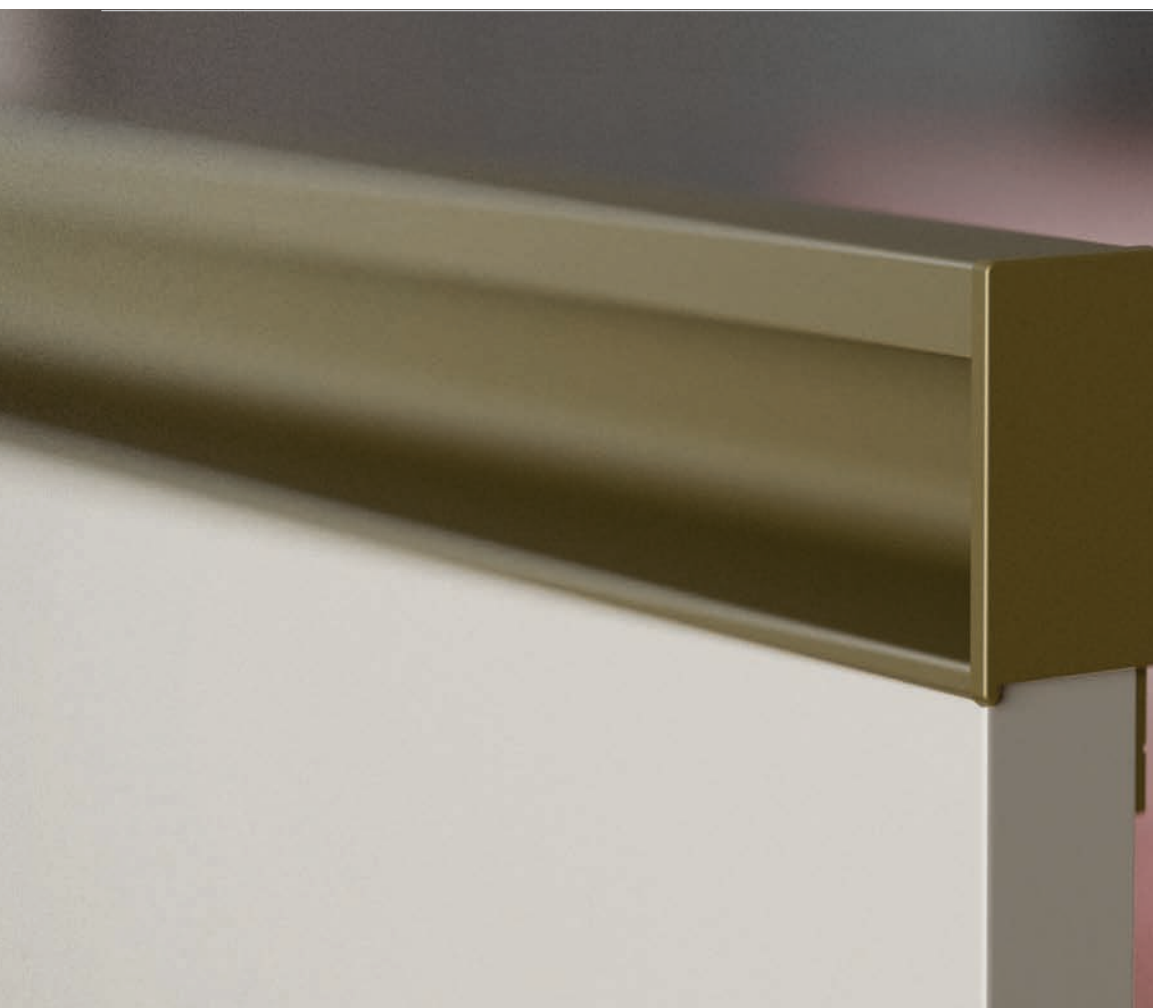
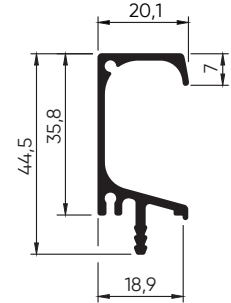

Perfil Puxador
Cód.: DES-1401

A ALUMICONTE reserva-se o direito de fazer modificações em qualquer informação contida neste catálogo sem aviso prévio. Os desenhos aqui contidos possuem medidas técnicas que podem sofrer alterações dimensionais de acordo com a ABNT NBR-8116, podendo haver variações dessas informações no produto final.

DES-102

Puxador de Encaixe | MDF 18 mm

0,423 Kg/m

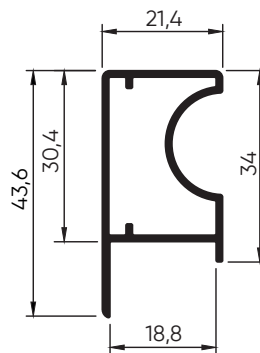
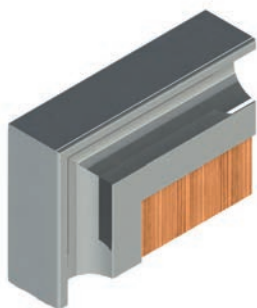

DES-162

Puxador de Encaixe | MDF 15 mm

0,437 Kg/m

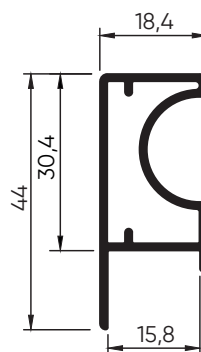

DES-222

Puxador de Encaixe | MDF 15 mm

0,384 Kg/m

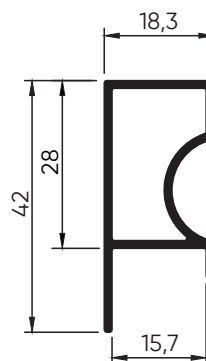
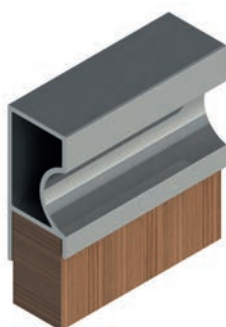

DES-307

Puxador de Encaixe | MDF 15 mm

0,396 Kg/m

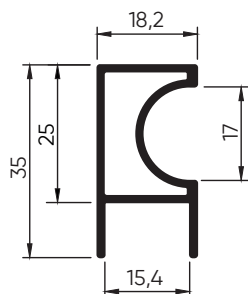

DES-291

Puxador de Encaixe | MDF 18 mm

0,445 Kg/m

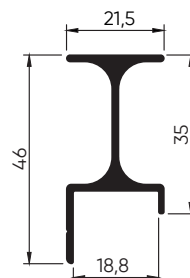

DES-063

Puxador de Embutir
0,440 Kg/m

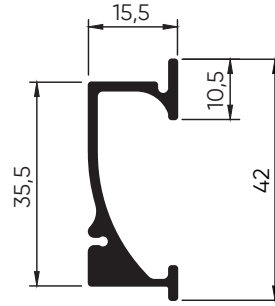

DES-064

Puxador de Embutir
0,366 Kg/m

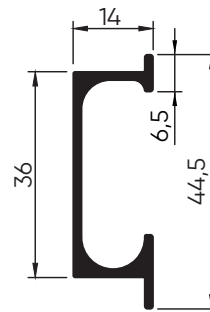
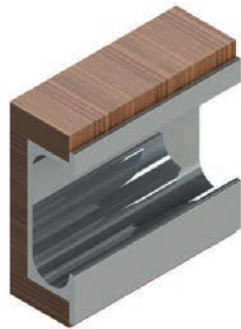

DES-046

Puxador de Embutir
0,112 Kg/m

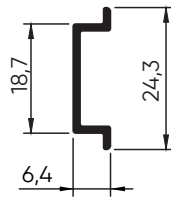

DES-347

Puxador de Embutir
0,354 Kg/m

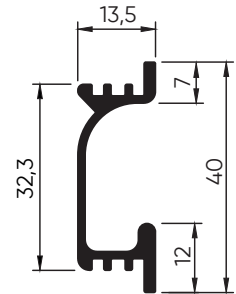
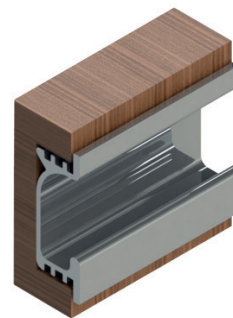

DES-881

Puxador de Embutir
0,383 Kg/m
Ponteira disponível

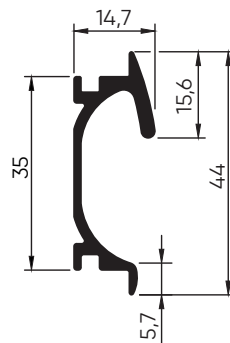

PONTEIRA
COMPATÍVEL



A ALUMICONTE reserva-se o direito de fazer modificações em qualquer informação escrita neste catálogo sem aviso prévio. Os desenhos aqui contidos possuem medidas teóricas de massa e tolerâncias dimensionais de acordo com a ABNT NBR-8116, podendo haver variações dessas informações no produto final.

QUADRO DE VIDRO

Projetados para estruturar o quadro e acomodar a folha de vidro com precisão, esses perfis se adaptam a diferentes posições, garantindo flexibilidade e excelência em cada projeto.



DES-912
Requadro do Vidro
0,552 Kg/m

Compatível • MONTAGEM
DES-1614 | DES-1226 | DES-226

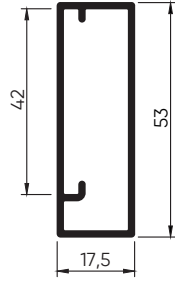

DES-1226
Quadro de Vidro
0,583 Kg/m

Compatível • MONTAGEM
DES-1225 | DES-1227 | DES-1228

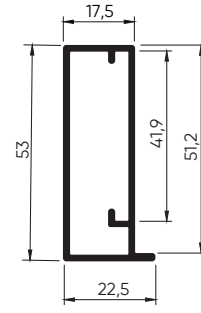

DES-1225
Quadro de Vidro com Puxador
0,676 Kg/m

Compatível • MONTAGEM
DES-1226 | DES-1227

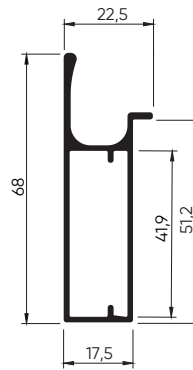

PONTEIRA COMPATÍVEL



DES-1227
Quadro de Vidro com Puxador
0,633 Kg/m

Compatível • MONTAGEM
DES-1225 | DES-1226 | DES-1228

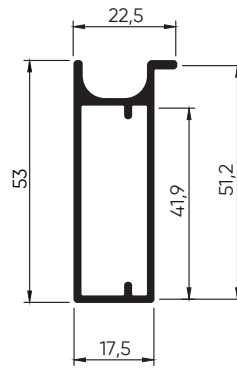

PONTEIRA COMPATÍVEL



DES-1228
Quadro de Vidro com Puxador
0,862 Kg/m

Compatível • MONTAGEM
DES-1226 | DES-1227

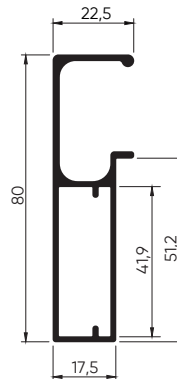

PONTEIRA COMPATÍVEL



A ALUMICONTE reserva-se o direito de fazer modificações em qualquer informação escrita neste catálogo sem aviso prévio. Os desenhos aqui contidos possuem medidas teóricas de massa e tolerâncias dimensionais de acordo com a ABNT NBR-8116, podendo haver variações dessas informações no produto final.

Perfis Quadro de Vidro e Quadro de Vidro com Puxador

Cód.: DES-1226 e DES-1225



DES-912

Requadro do Vidro

0,552 Kg/m

Compatível • MONTAGEM
DES-1614 | DES-1226 | DES-226

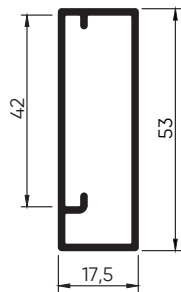

DES-225

Quadro Pele de Vidro com Puxador

0,698 Kg/m

Compatível • MONTAGEM
DES-226 | DES-227

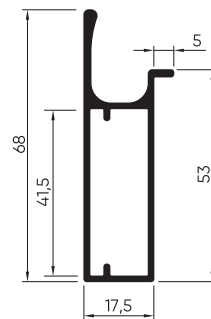
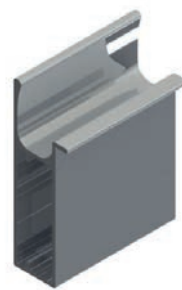

PONTEIRA COMPATÍVEL



DES-226

Requadro do Vidro

0,591 Kg/m

Compatível • MONTAGEM
DES-1614 | DES-1226 | DES-226

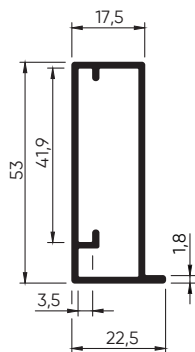

DES-227

Quadro Pele de Vidro com Puxador

0,608 Kg/m

Compatível • MONTAGEM
DES-226 | DES-227

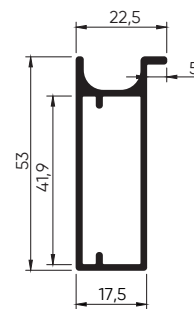

PONTEIRA COMPATÍVEL



DES-1271

Quadro de Vidro com Puxador

0,862 Kg/m

Compatível • MONTAGEM
DES-1614 | DES-1226 | DES-226

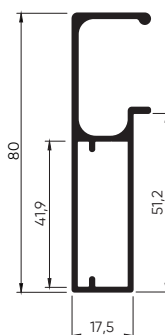

PONTEIRA COMPATÍVEL



A ALUMICONTE reserva-se o direito de fazer modificações em qualquer informação escrita neste catálogo sem aviso prévio. Os desenhos aqui contidos possuem medidas teóricas de massa e tolerâncias dimensionais de acordo com a ABNT NBR-8116, podendo haver variações dessas informações no produto final.

DES-1042

Quadro de Vidro
0,562 Kg/m

Compatível • MONTAGEM
DES-1043

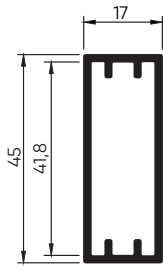

ESQUADRETA
ESQ-001



DES-1043

Requadro de Vidro com Puxador
0,939 Kg/m

Compatível • MONTAGEM
DES-1042

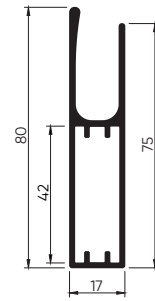

ESQUADRETA
ESQ-001



DES-1093

Requadro de Vidro
0,536 Kg/m

Compatível • MONTAGEM
DES-1094

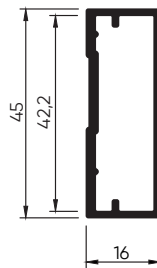

ESQUADRETA
ESQ-001



DES-1094

Requadro Pele de Vidro com Puxador
0,879 Kg/m

Compatível • MONTAGEM
DES-1093

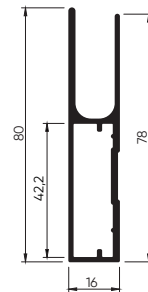

ESQUADRETA
ESQ-001



Perfil Requadro Pele
de Vidro com Puxador
Cód.: DES-1094

A ALUMICONTE reserva-se o direito de fazer modificações em qualquer informação escrita neste catálogo sem aviso prévio. Os desenhos aqui contidos possuem medidas teóricas de massa e tolerâncias dimensionais de acordo com a ABNT NBR 5100, podendo haver variações dessas informações no produto final.

DES-198

Quadro de Vidro - 4,5mm
0,462 Kg/m

Compatível • MONTAGEM
DES-877 | DES-950 | DES-282
DES-204 | DES-897 | DES-856
Compatível • PUXADOR
DES-112 | DES-203 | DES-239
DES-1252 | DES-1299 | DES-1324

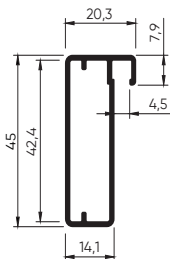

DES-204

Quadro de Vidro com Puxador
0,855 Kg/m

Compatível • MONTAGEM
DES-198

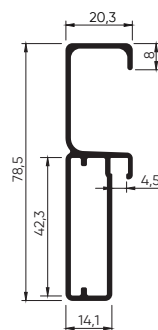

DES-877

Quadro de Vidro com Puxador
0,524 Kg/m

Compatível • MONTAGEM
DES-198

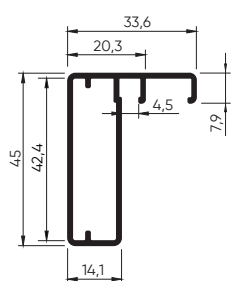
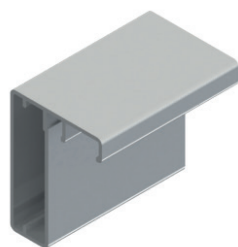

DES-950

Quadro de Vidro com Puxador
0,801 Kg/m
Ponteira disponível

Compatível • MONTAGEM
DES-198

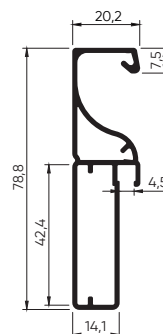

DES-282

Quadro de Vidro com Puxador
0,800 Kg/m
Ponteira disponível

Compatível • MONTAGEM
DES-198

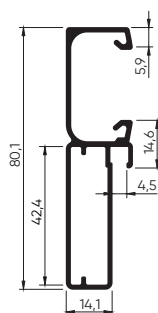
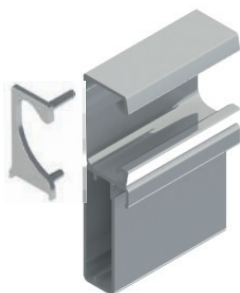

DES-897

Quadro de Vidro com Puxador
0,681 Kg/m

Compatível • MONTAGEM
DES-198

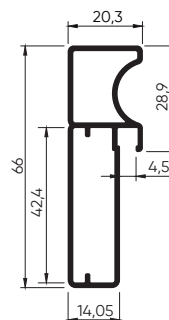
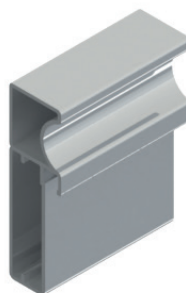

DES-730

Quadro de Vidro com Puxador
0,831 Kg/m
Ponteira disponível

Compatível • MONTAGEM
DES-198

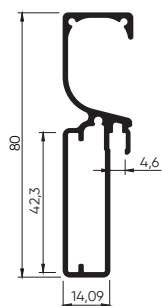
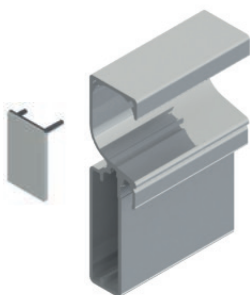

DES-856

Travessa Quadro de Vidro
0,196 Kg/m

Compatível • MONTAGEM
DES-198 | DES-311

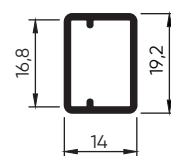

A ALUMICONTE reserva-se o direito de fazer modificações em qualquer informação escrita neste catálogo sem aviso prévio. Os desenhos aqui contidos possuem medidas teóricas de massa e tolerâncias dimensionais de acordo com o ABNT NBR-8116, podendo haver variações dessas informações no produto final.

DES-311
Quadro de Vidro
0,454 Kg/m

Compatível • MONTAGEM
DES-370 | DES-856
Compatível • PUXADOR
DES-203 | DES-1299 | DES-1324 | DES-2185
DES-296 | DES-395 | DES-1319

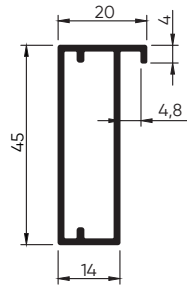

DES-370
Quadro de Vidro com Puxador
0,701 Kg/m

Compatível • MONTAGEM
DES-1311

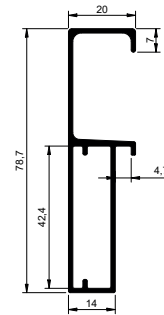

DES-1402
Quadro de Vidro
0,497 Kg/m

Compatível • MONTAGEM
DES-1403 | DES-1016
Compatível • PUXADOR
DES-239 | DES-112 | DES-2185
DES-296 | DES-395 | DES-1319

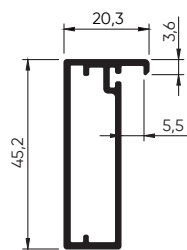

DES-1016
Travessa Quadro de Vidro
0,232 Kg/m

Compatível • MONTAGEM
DES-1403

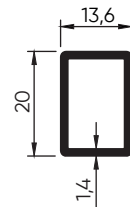

DES-1403
Quadro Pele de Vidro com Puxador
0,772 Kg/m
Ponteira disponível

Compatível • MONTAGEM
DES-1402

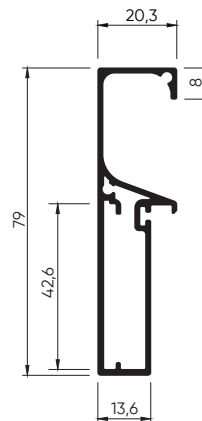
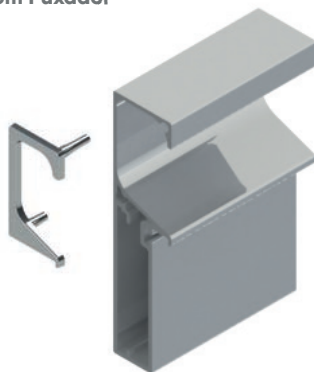

DES-1264
Quadro de Vidro
0,395 Kg/m

Compatível • MONTAGEM
DES-1268
Compatível • PUXADOR
DES-239 | DES-112 | DES-2185
DES-296 | DES-395 | DES-1319

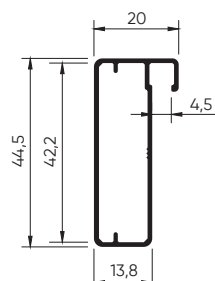

DES-1268
Quadro de Vidro com Puxador
0,754 Kg/m

Compatível • MONTAGEM
DES-1264

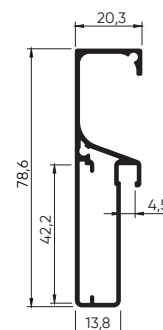

A ALUMICONTE reserva-se o direito de fazer modificações em qualquer informação escrita neste catálogo sem aviso prévio. Os desenhos aqui contidos possuem medidas teóricas de massa e tolerâncias dimensionais de acordo com a ABNT NBR-8116, podendo haver variações dessas informações no produto final.

DES-691

Quadro de Vidro
0,502 Kg/m

Compatível • MONTAGEM
DES-1419 | DES-692

Compatível • PUXADOR
DES-239 | DES-112 | DES-2185
DES-296 | DES-395 | DES-1319

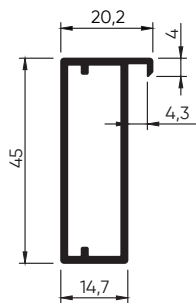

DES-1419

Quadro de Vidro com Puxador
0,809 Kg/m
Ponteira disponível

Compatível • MONTAGEM
DES-691

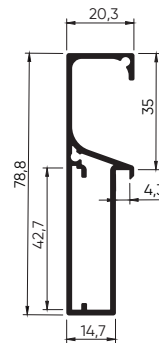

DES-692

Quadro de Vidro
0,619 Kg/m

Compatível • MONTAGEM
DES-691

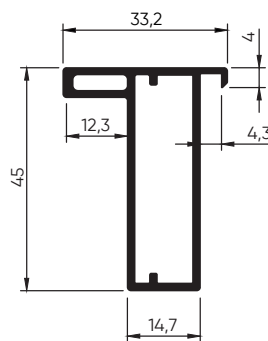

DES-1789

Quadro de Vidro Porta Reforçado
1,066 Kg/m

Compatível • MONTAGEM
DES-2192

Compatível • PUXADOR
DES-2193

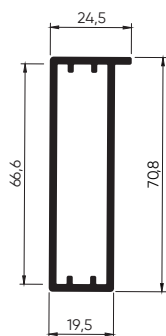
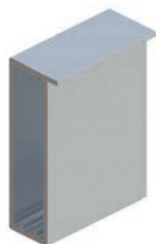

DES-2192

Quadro de Vidro com Puxador
1,175 Kg/m

Compatível • MONTAGEM
DES-1789

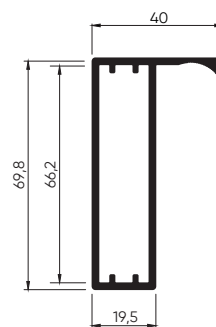

DES-2193

Puxador 25
0,409 Kg/m

Compatível • MONTAGEM
DES-1789

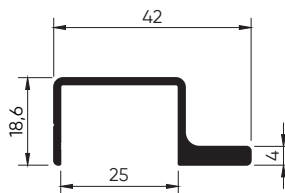
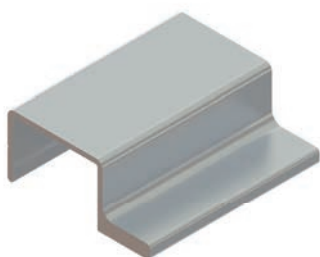

DES-1073

Quadro de Vidro
0,481 Kg/m

Compatível • MONTAGEM
DES-1074 | DES-1075
DES-2349 | DES-1697

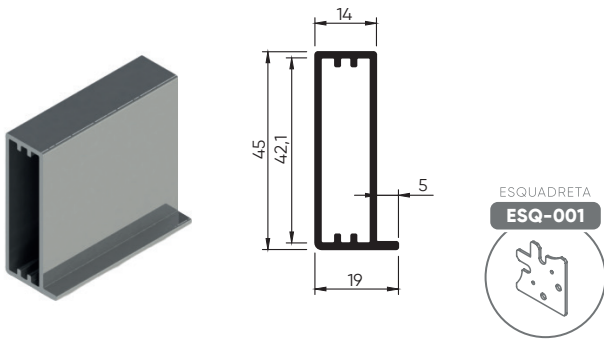

DES-1074

Quadro de Vidro com Puxador
0,628 Kg/m

Compatível • MONTAGEM
DES-1073 | DES-1075

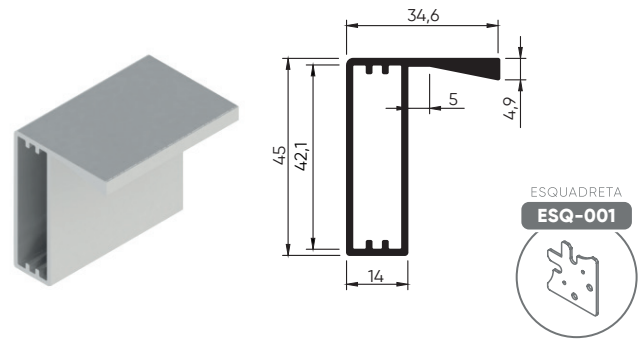

DES-1075

Travessa Intermediária
0,469 Kg/m

Compatível • MONTAGEM
DES-1074 | DES-1075
DES-2349 | DES-1697

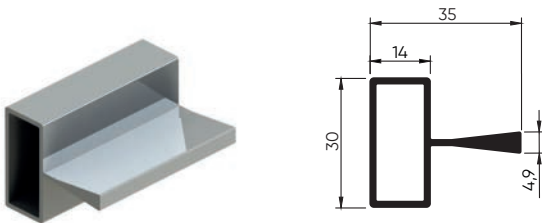

DES-2349

Quadro de vidro com puxador
0,601 Kg/m

Compatível • MONTAGEM
DES-1073 | DES-1075

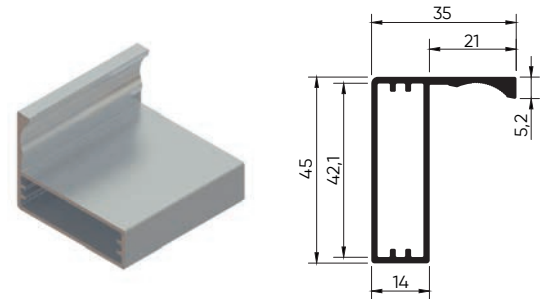

DES-1697

Quadro de Vidro com Puxador
0,599 Kg/m

Compatível • MONTAGEM
DES-1073 | DES-1075

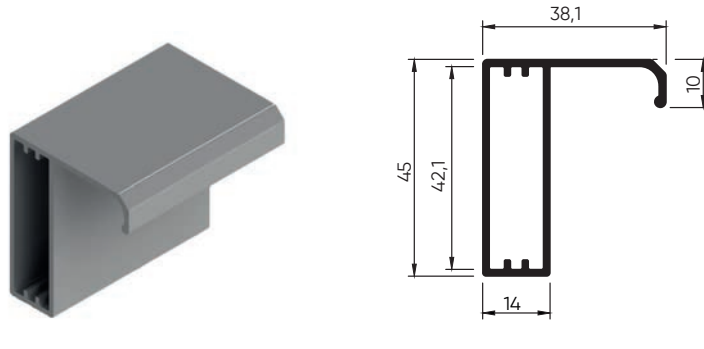

DES-233

Quadro de Vidro
0,479 Kg/m

Compatível • PUXADOR
DES-232 | DES-043 | DES-112
DES-842 | DES-1278 | DES-1324

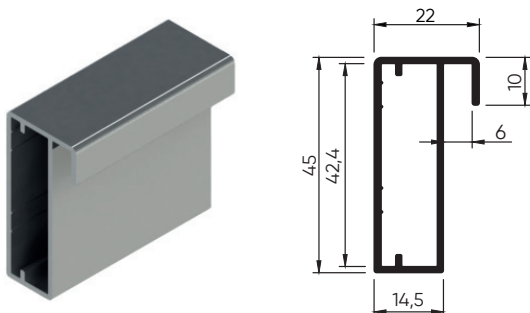

DES-232

Puxador Encaixe Interno 11mm
0,151 Kg/m

Compatível • MONTAGEM
DES-233

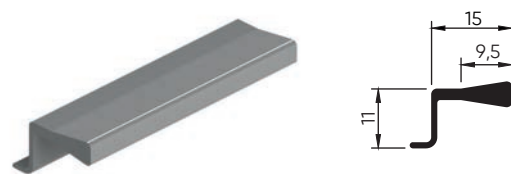

DES-1407

Quadro Pele de Vidro
0,285 Kg/m

Compatível • MONTAGEM
DES-1408

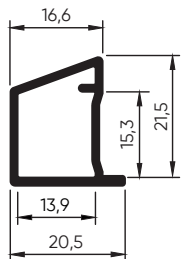

DES-1408

Quadro de Vidro com Puxador
0,704 Kg/m

Compatível • MONTAGEM
DES-1407

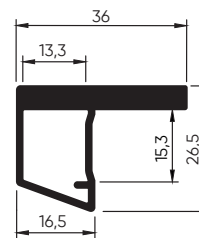

DES-1490

Quadro de Vidro
0,546 Kg/m

Compatível • MONTAGEM
DES-1489

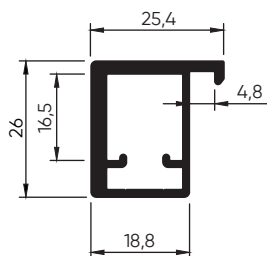

DES-1489

Quadro de Vidro com Puxador
0,684 Kg/m

Compatível • MONTAGEM
DES-1490

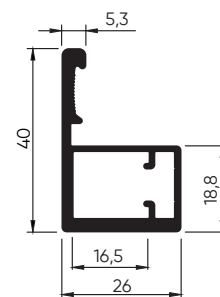

DES-1492

Quadro Pele de Vidro
0,524 Kg/m

Compatível • MONTAGEM
DES-1491

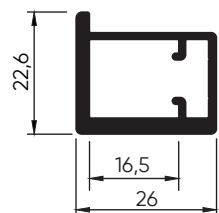

DES-1491

Quadro de Vidro com Puxador
0,644 Kg/m

Compatível • MONTAGEM
DES-1492

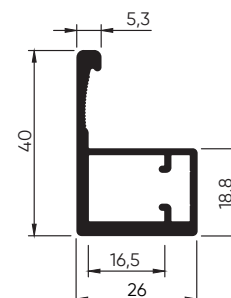

DES-2351

Quadro de Vidro
0,551 Kg/m

Compatível • MONTAGEM
DES-2350

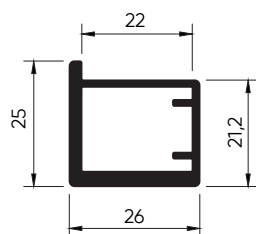
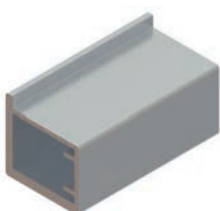

DES-2350

Quadro de Vidro com Puxador
0,686 Kg/m

Compatível • MONTAGEM
DES-2351

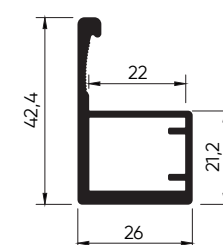
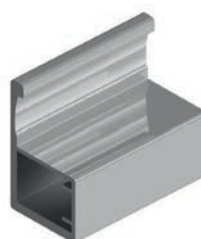

A ALUMICONTE reserva-se o direito de fazer modificações em qualquer informação escrita neste catálogo sem aviso prévio. Os desenhos aqui contidos possuem medidas teóricas de massa e tolerâncias dimensionais de acordo com a ABNT NBR-8116, podendo haver variações dessas informações no produto final.

DES-313

Quadro de Vidro com Puxador
0,574 Kg/m

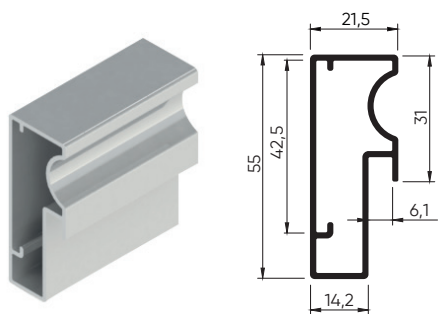

DES-320

Quadro de Vidro com Puxador
0,566 Kg/m

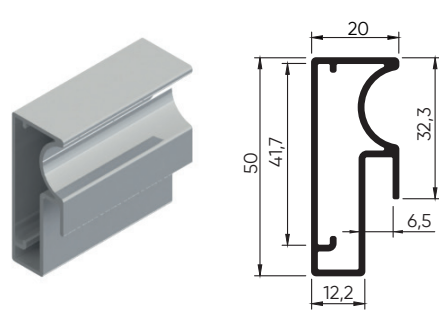

DES-012

Quadro de Vidro com Puxador
0,558 Kg/m

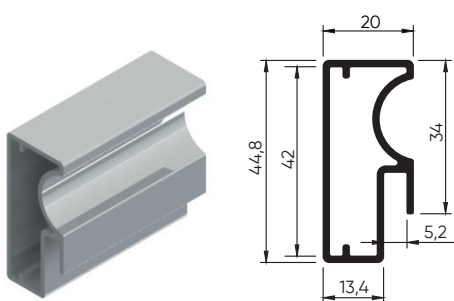

DES-1265

Quadro de Vidro com Puxador
0,505 Kg/m

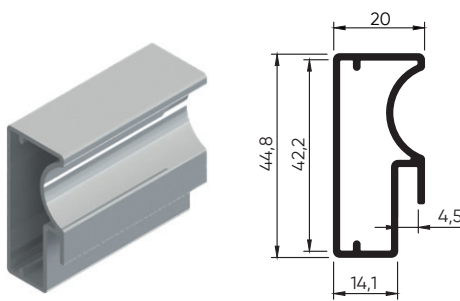

DES-011

Quadro de Vidro com Puxador
0,668 Kg/m

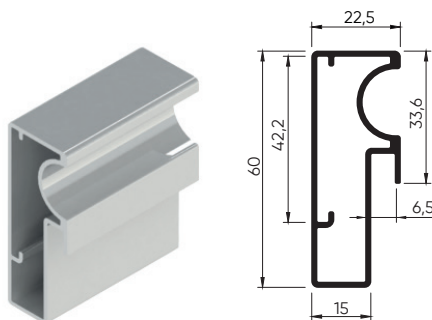

DES-1012

Quadro de Vidro com Puxador
0,486 Kg/m

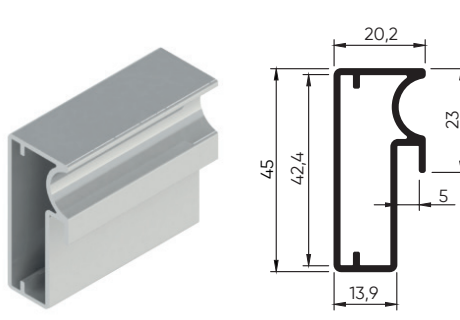

DES-026

Quadro de Vidro com Puxador
0,453 Kg/m

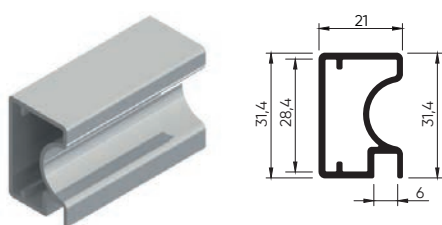

DES-187

Quadro de Vidro com Puxador
0,635 Kg/m

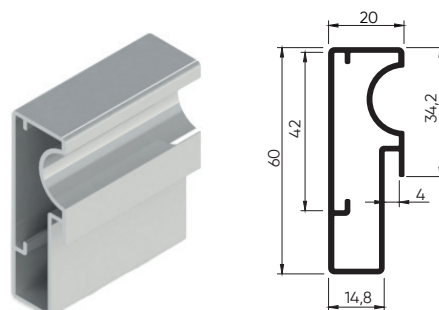

A ALUMICONTE reserva-se o direito de fazer modificações em qualquer informação escrita neste catálogo sem aviso prévio. Os desenhos aqui contidos possuem medidas teóricas de massa e tolerâncias dimensionais de acordo com a ABNT NBR-8116, podendo haver variações dessas informações no produto final.

DES-078

Quadro de Vidro com Puxador
0,520 Kg/m

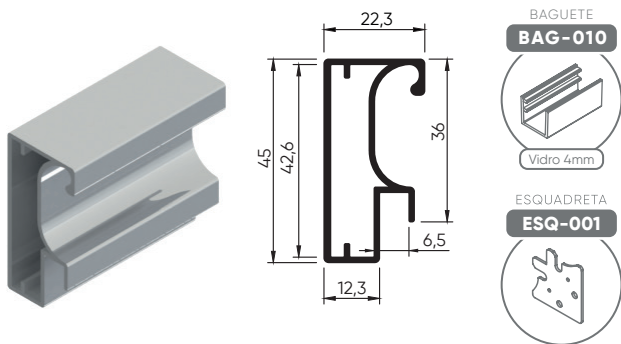

DES-279

Quadro de Vidro com Puxador
0,523 Kg/m

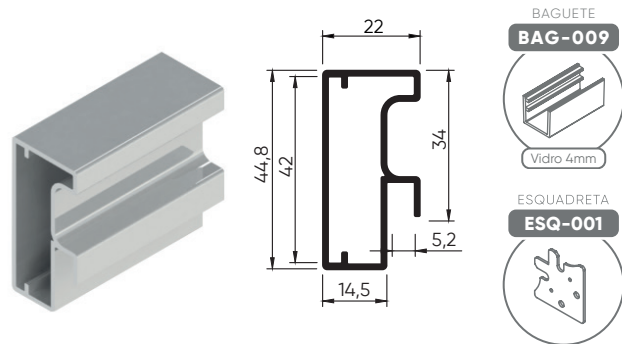

DES-951

Quadro Pele de Vidro
0,721 Kg/m

Compatível • MONTAGEM
DES-952

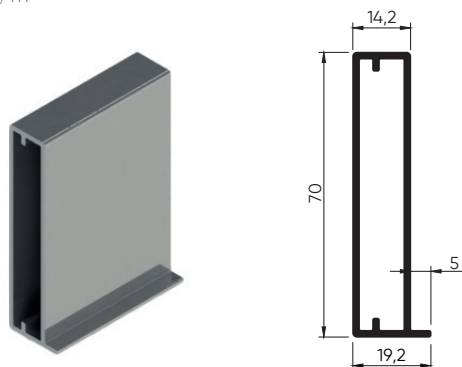

DES-952

Travessa Quadro de Vidro
0,317 Kg/m

Compatível • MONTAGEM
DES-951

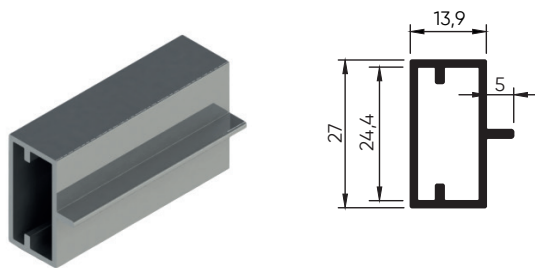

DES-247

Travessa Quadro de Vidro
0,262 Kg/m

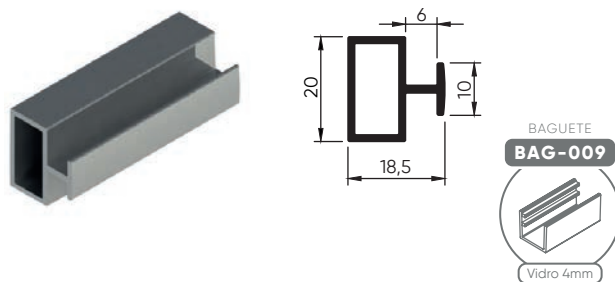

DES-077

Travessa Quadro de Vidro
0,160 Kg/m

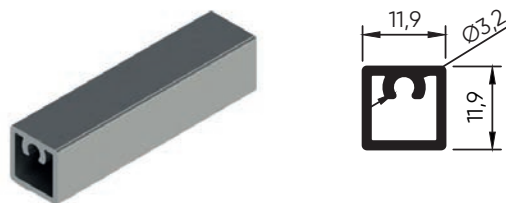

DES-014

Quadro de Vidro
0,459 Kg/m

Compatível • MONTAGEM
DES-856

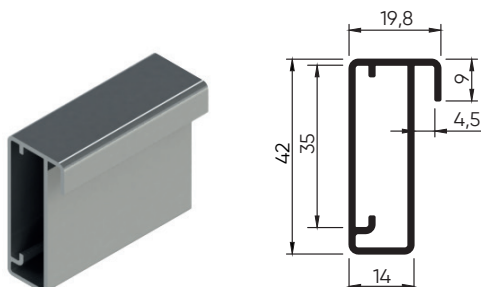

DES-856

Travessa Quadro de Vidro
0,196 Kg/m

Compatível • MONTAGEM
DES-014

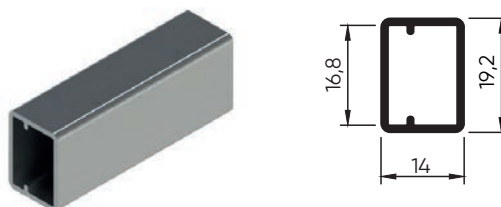

DES-1250

Quadro de Vidro
0,443 Kg/m

Compatível • PUXADOR
DES-519

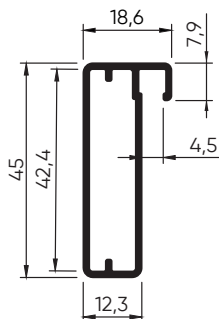

DES-929

Quadro de Vidro
0,488 Kg/m

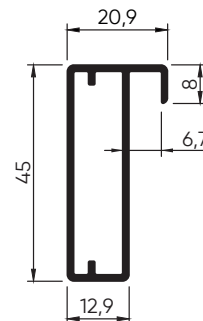

DES-001

Quadro de Vidro
0,466 Kg/m

Compatível • PUXADOR
DES-112 | DES-842

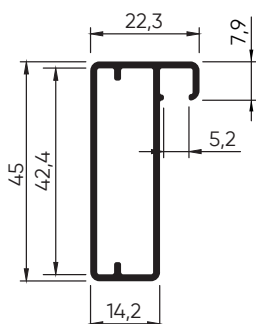

DES-007

Quadro de Vidro
0,508 Kg/m

Compatível • PUXADOR
DES-239

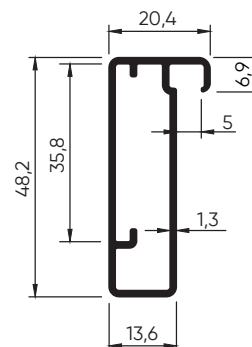

DES-721

Quadro de Vidro
0,559 Kg/m

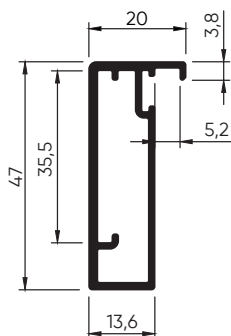

DES-875

Quadro de Vidro
0,443 Kg/m

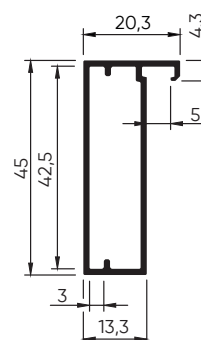

DES-084

Quadro de Vidro
0,407 Kg/m

Compatível • PUXADOR
DES-519

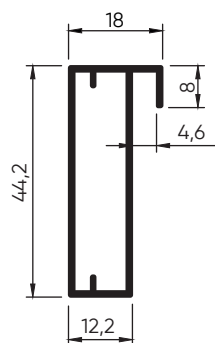
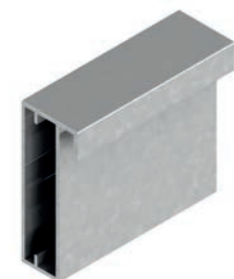

DES-318

Quadro de Vidro
0,427 Kg/m

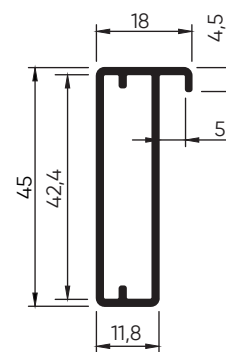

A ALUMICONTE reserva-se o direito de fazer modificações em qualquer informação escrita neste catálogo sem aviso prévio. Os desenhos aqui contidos possuem medidas teóricas de massa e tolerâncias dimensionais de acordo com a ABNT NBR-8116, podendo haver variações dessas informações no produto final.

DES-062

Quadro de Vidro
0,455 Kg/m

Compatível • PUXADOR
DES-1299 | DES-1324

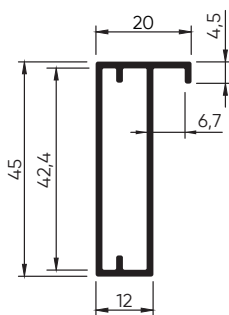

DES-530

Quadro de Vidro
0,433 Kg/m

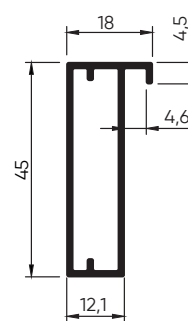

DES-550

Quadro de Vidro
0,438 Kg/m

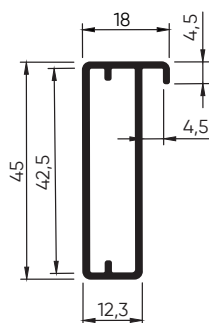

DES-133

Quadro de Vidro
0,508 Kg/m

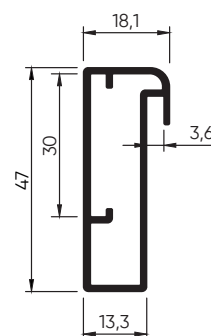

DES-002

Quadro de Vidro
0,798 Kg/m

Compatível • PUXADOR
DES-112 | DES-842 | DES-1613

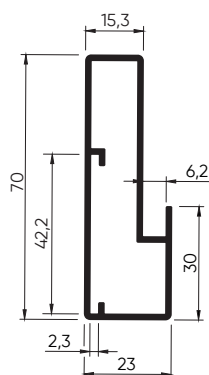

DES-010

Quadro de Vidro
0,451 Kg/m

Compatível • PUXADOR
DES-203 | DES-1299 | DES-1324

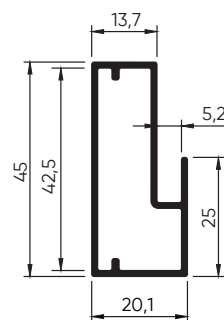

DES-1326

Quadro de Vidro
0,658 Kg/m

Compatível • PUXADOR
DES-043

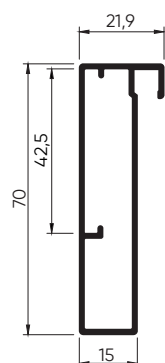

DES-1328

Quadro de Vidro
0,863 Kg/m

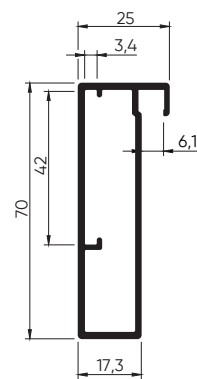

A ALUMICONTE reserva-se o direito de fazer modificações em qualquer informação escrita neste catálogo sem aviso prévio. Os desenhos aqui contidos possuem medidas teóricas de massa e tolerâncias dimensionais de acordo com a ABNT NBR-8116, podendo haver variações dessas informações no produto final.

DES-1612

Quadro de Vidro
0,819 Kg/m

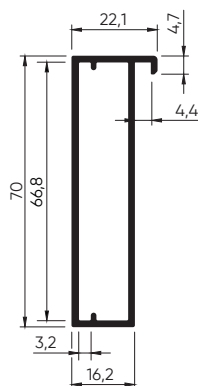

Compatível • PUXADOR
DES-043 | DES-112 | DES-842

DES-902

Quadro de Vidro
0,792 Kg/m

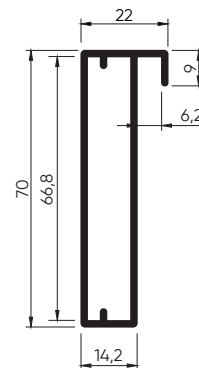

Compatível • PUXADOR
DES-239 | DES-1299 | DES-1324

DES-297

Quadro de Vidro
0,671 Kg/m

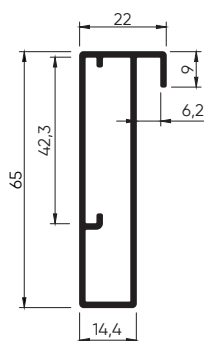

Compatível • PUXADOR
DES-043 | DES-112 | DES-842 | DES-1278

DES-060

Quadro de Vidro
0,422 Kg/m

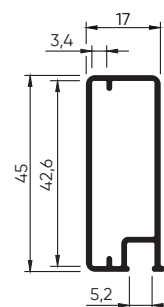

DES-1934

Folha Encaixilhada
0,301 Kg/m

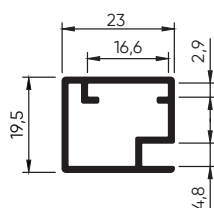
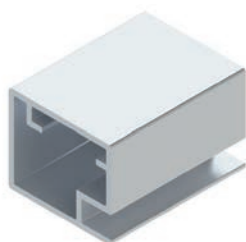

DES-016

Quadro de Vidro
0,469 Kg/m

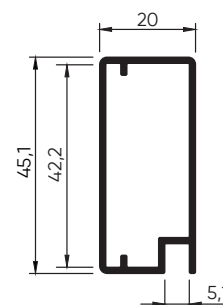

DES-1279

Quadro Pele de Vidro
0,472 Kg/m

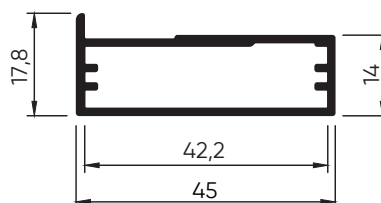
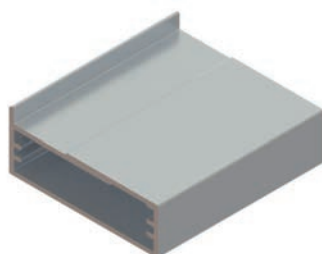

A ALUMICONTE reserva-se o direito de fazer modificações em qualquer informação escrita neste catálogo sem aviso prévio. Os desenhos aqui contidos possuem medidas teóricas de massa e tolerâncias dimensionais de acordo com a ABNT NBR-8116, podendo haver variações dessas informações no produto final.



Perfil Quadro para MDF
Cód.: DES-2074

DES-2074

Requadro Aplicação MDF 6mm
0,516 Kg/m

Compatível • PUXADOR
DES-239 | DES-1299

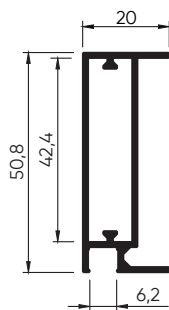

Simulação de montagem

DES-2075

Quadro Porta Aplicação para Porcelanato
0,488 Kg/m

Compatível • PUXADOR
DES-043 | DES-112

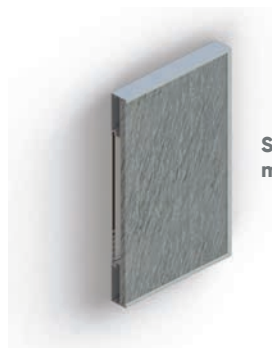
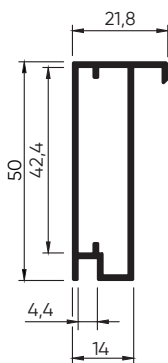

Simulação de montagem

ESQUADRETA

ESQ-001



A ALUMICONTE reserva-se o direito de alterar sem qualquer informação escrita neste catálogo sem aviso prévio. Os desenhos aqui contidos possuem medidas teóricas e não representam a realidade. Podem ocorrer variações de cor e acabamento devido a diferenças de materiais e processos de fabricação. Para mais informações, consulte o site www.alumiconte.com.br



Perfil Quadro para Porcelanato
Cód.: DES-2075

DES-2425

Quadro Pele de Vidro
0,458 Kg/m

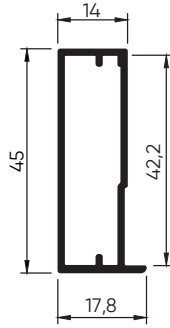
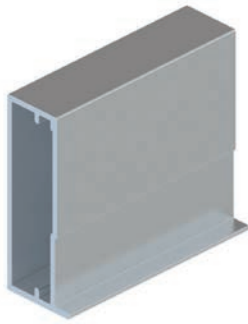

DES-953

Quadro Pele de Vidro
0,459 Kg/m

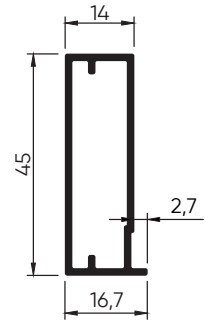
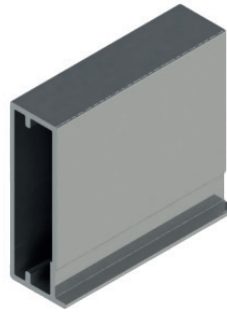

DES-1451

Quadro Pele de Vidro
0,983 Kg/m

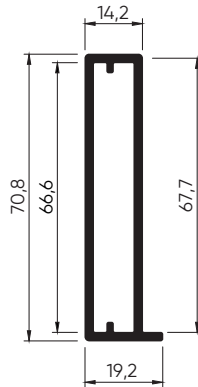

DES-1414

Quadro Pele de Vidro
0,506 Kg/m

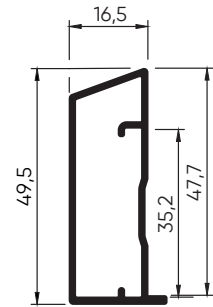

DES-073

Quadro Pele de Vidro
0,491 Kg/m

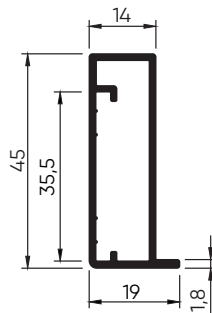

Compatível • PUXADOR
DES-909

DES-1321

Quadro Pele de Vidro
0,890 Kg/m

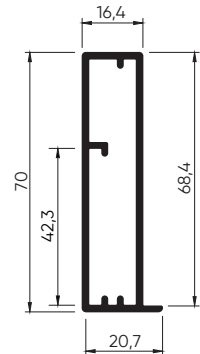

DES-147

Quadro Pele de Vidro
0,382 Kg/m

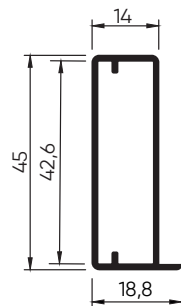
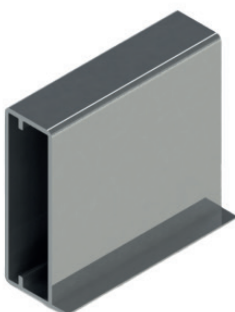

DES-3098

Quadro Pele de Vidro 45x18,8mm
0,383 Kg/m

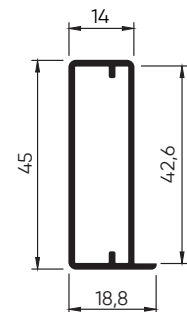

A ALUMICONTE reserva-se o direito de fazer modificações em qualquer informação escrita neste catálogo sem aviso prévio. Os desenhos aqui contidos possuem medidas teóricas de massa e tolerâncias dimensionais de acordo com a ABNT NBR-8116, podendo haver variações dessas informações no produto final.

DES-1291

Quadro de Vidro
0,576 Kg/m

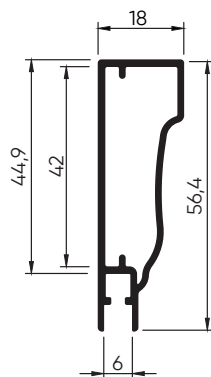

DES-178

Quadro de Vidro
0,376 Kg/m

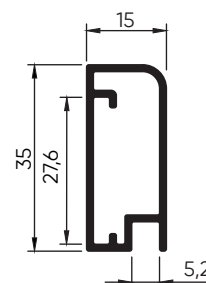

DES-019

Quadro de Vidro
0,421 Kg/m

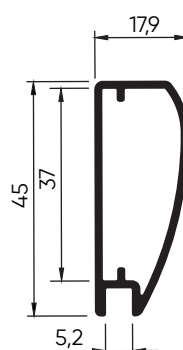

DES-017

Quadro de Vidro
0,495 Kg/m

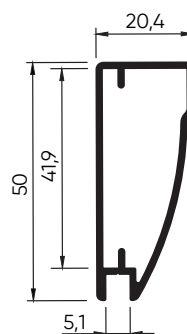

DES-015

Quadro de Vidro
0,372 Kg/m

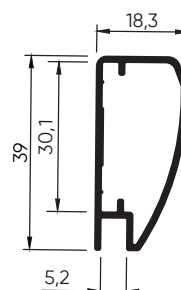
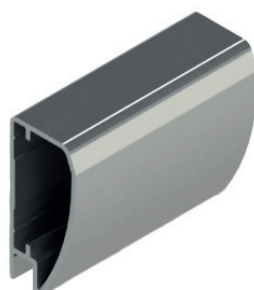

A ALUMICONTE reserva-se o direito de fazer modificações em qualquer informação escrita neste catálogo sem aviso prévio. Os desenhos aqui contidos possuem medidas teóricas de massa e tolerâncias dimensionais de acordo com a ABNT NBR-8116, podendo haver variações dessas informações no produto final.

DES-043

Puxador de Encaixe
0,304 Kg/m

Compatível • MONTAGEM
DES-233 | DES-297 | DES-832
DES-902 | DES-1326 | DES-1612

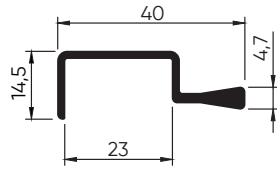
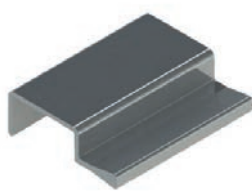

DES-239

Puxador de Encaixe
0,283 Kg/m

Compatível • MONTAGEM
DES-007 | DES-008 | DES-014 | DES-198
DES-721 | DES-875 | DES-1264

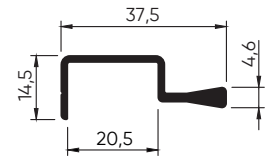
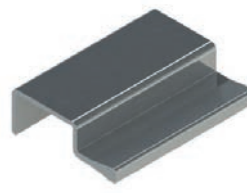

DES-519

Puxador de Encaixe
0,282 Kg/m

Compatível • MONTAGEM
DES-089 | DES-300
DES-1250 | DES-1443

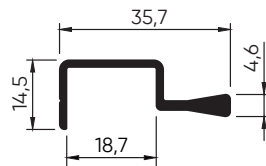
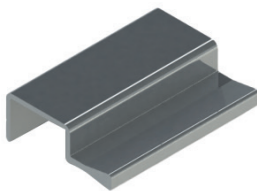

DES-1613

Puxador de Encaixe
0,356 Kg/m

Compatível • MONTAGEM
DES-002

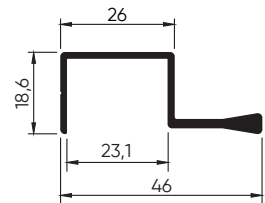
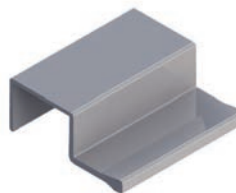

DES-1614

Puxador de Encaixe
0,345 Kg/m

Compatível • MONTAGEM
DES-300 | DES-912

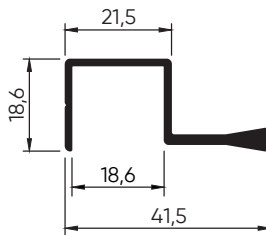
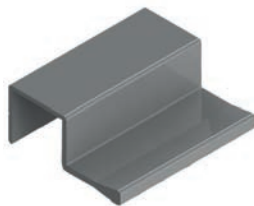

DES-1251

Puxador de Encaixe
0,266 Kg/m

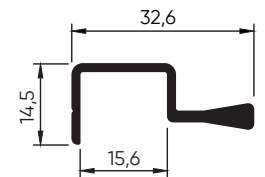

DES-2185

Puxador Quadro 20
0,277 Kg/m

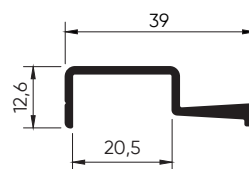
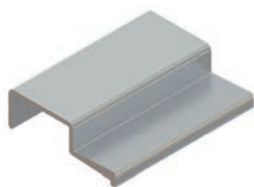

DES-2184

Puxador de Encaixe
0,269 Kg/m

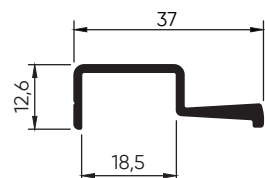
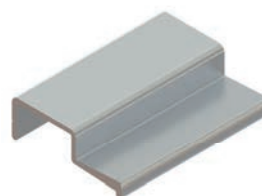

A ALUMICONTE reserva-se o direito de fazer modificações em qualquer informação escrita neste catálogo sem aviso prévio. Os desenhos aqui contidos possuem medidas teóricas de massa e tolerâncias dimensionais de acordo com a ABNT NBR-8116, podendo haver variações dessas informações no produto final.

DES-1420

Puxador de Encaixe
0,352 Kg/m

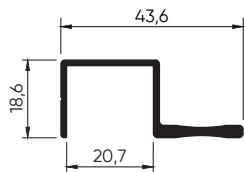
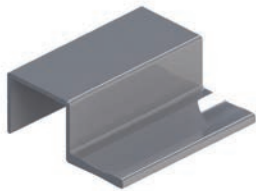

DES-112

Puxador de Encaixe
0,316 Kg/m

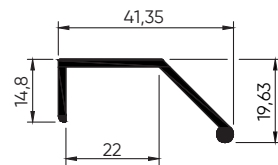
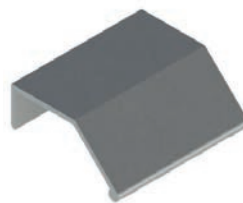

Compatível • MONTAGEM
DES-001 | DES-002 | DES-198 | DES-233
DES-297 | DES-902 | DES-1612

DES-842

Puxador de Encaixe
0,240 Kg/m

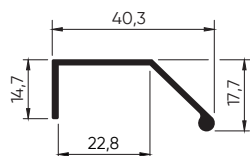
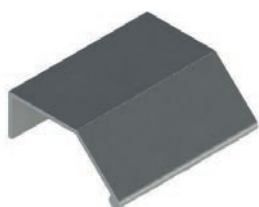

Compatível • MONTAGEM
DES-001 | DES-002 | DES-233
DES-297 | DES-902 | DES-1612

DES-203

Puxador de Encaixe - 15mm
0,259 Kg/m

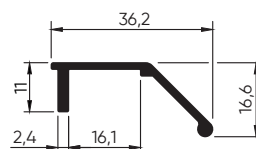
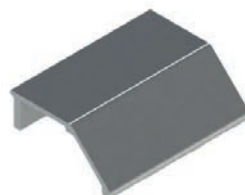

Compatível • MONTAGEM
DES-010 | DES-198
DES-311 | DES-691

DES-909

Puxador de Encaixe
0,279 Kg/m

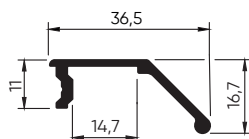
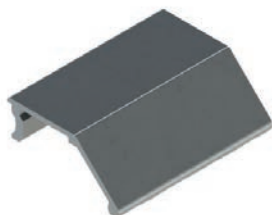

Compatível • MONTAGEM
DES-073

DES-993

Puxador de Encaixe
0,214 Kg/m

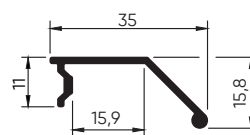

DES-1278

Puxador de Encaixe
0,268 Kg/m

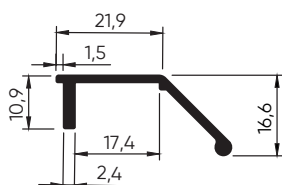
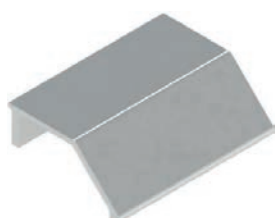

Compatível • MONTAGEM
DES-233 | DES-297

DES-148

Puxador de Encaixe Interno
0,245 Kg/m

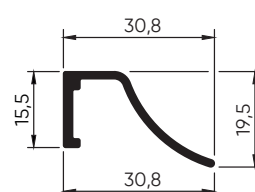

DES-296

Puxador de Encaixe
0,246 Kg/m

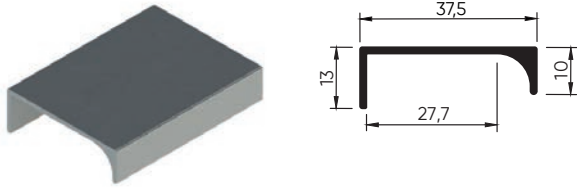

DES-395

Puxador de Encaixe
0,293 Kg/m

Compatível · MONTAGEM
ARM-062 | ARM-198

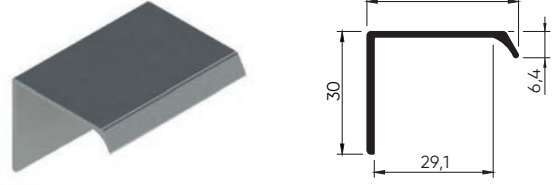

DES-1319

Puxador de Encaixe
0,372 Kg/m

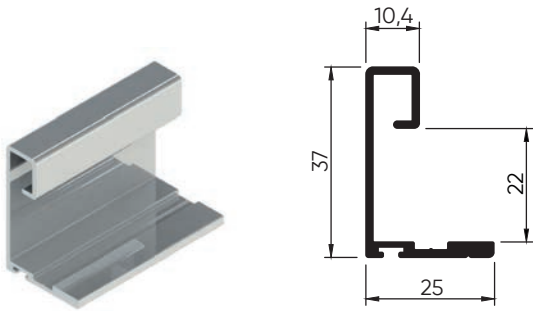

DES-1329

Puxador de Encaixe
0,364 Kg/m

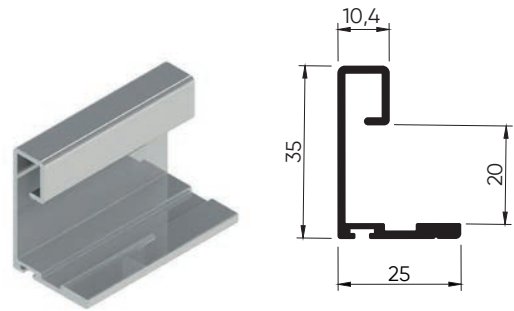

DES-1332

Puxador de Encaixe
0,383 Kg/m

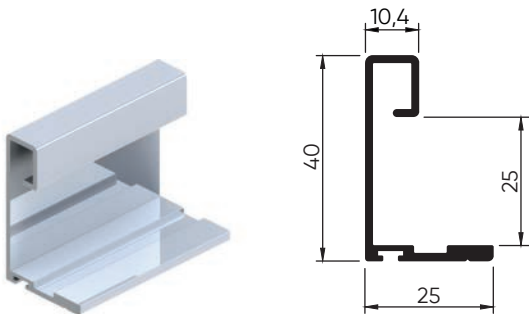

DES-901

Puxador de Encaixe
0,230 Kg/m

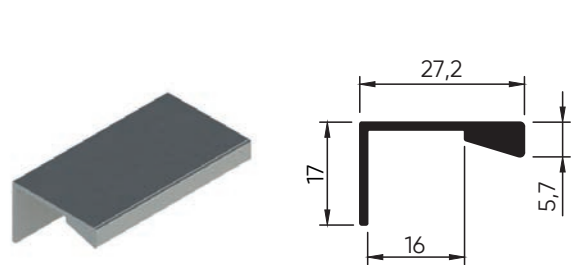

DES-1324

Puxador de Encaixe
0,218 Kg/m

Compatível · MONTAGEM
DES-010 | DES-062 | DES-198 | DES-233 |
DES-311 | DES-691 | DES-875

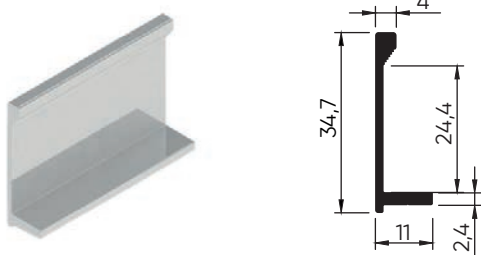

DES-1299

Puxador de Encaixe
0,261 Kg/m

Compatível · MONTAGEM
DES-010 | DES-198
DES-311 | DES-691

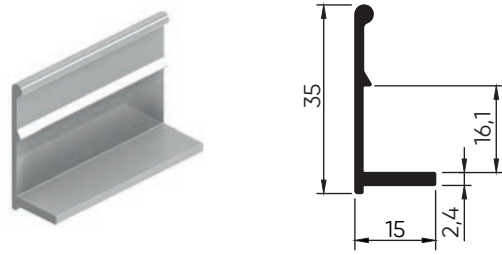

A ALUMICONTE reserva-se o direito de fazer modificações em qualquer informação escrita neste catálogo sem aviso prévio. Os desenhos aqui contidos possuem medidas teóricas de massa e tolerâncias dimensionais de acordo com a ABNT NBR-8116, podendo haver variações dessas informações no produto final.

DES-2347

Puxador de Encaixe
0,170 Kg/m

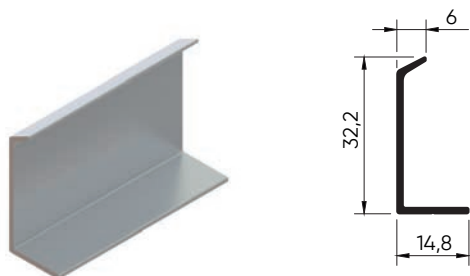

DES-2348

Puxador de Encaixe
0,157 Kg/m

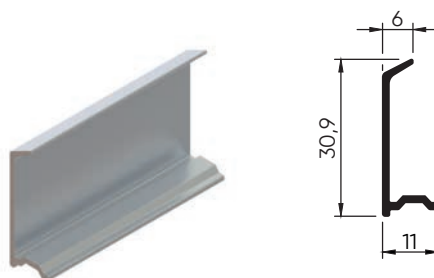

DES-2822

Puxador de Embutir Reto
0,218 Kg/m

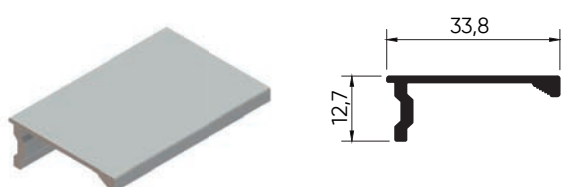

DES-2892

Puxador de Sobrepor Reto
0,191 Kg/m

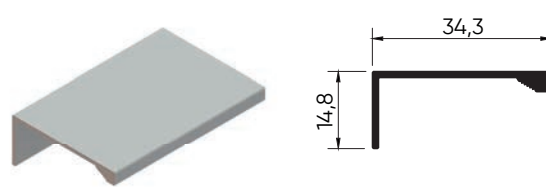

Perfil Puxador de Encaixe
Cód.: DES-2185



Alumiconte ARMO



ALUMICONTE ARMO

Especialmente desenvolvida para entregar o melhor custo-benefício para você. Praticidade, qualidade e leveza!

ARM-062

Quadro de Vidro
0,335 Kg/m

Compatível • PUXADOR
DES-239

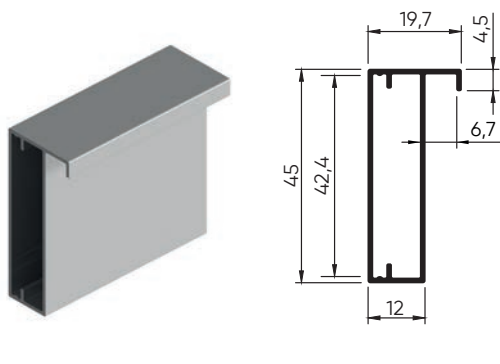

DES-239

Puxador Encaixe
0,283 Kg/m

Compatível • MONTAGEM
ARM-062 | DES-007 | DES-008
DES-014 | DES-198 | DES-721
DES-875 | DES-1264

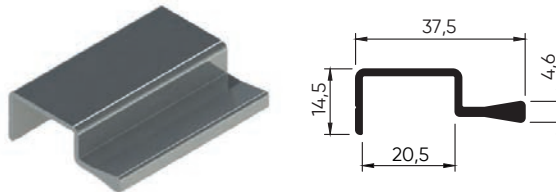

ARM-530

Quadro de Vidro
0,329 Kg/m

Compatível • PUXADOR
DES-395

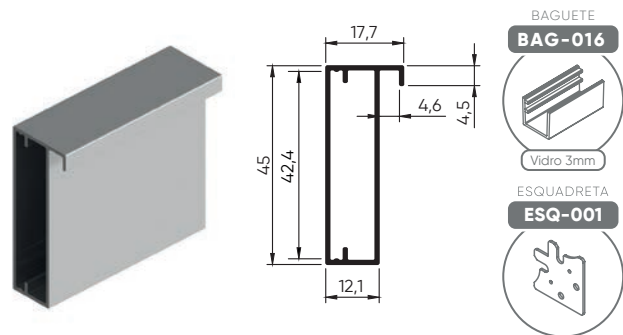

DES-395

Puxador Encaixe
0,293 Kg/m

Compatível • MONTAGEM
ARM-062 | ARM-198 | ARM-530

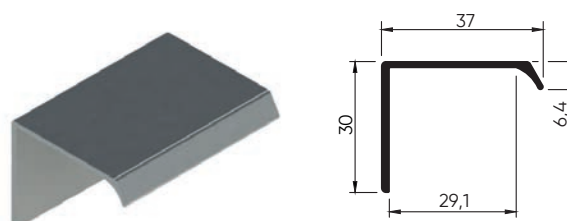

ARM-198

Quadro de Vidro
0,350 Kg/m

Compatível • MONTAGEM
ARM-204

Compatível • PUXADOR
ARM-239 | DES-395

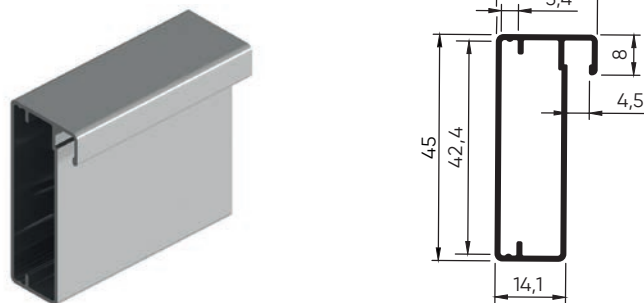

ARM-3047

Puxador
0,286 Kg/m

Compatível • MONTAGEM
DES-198

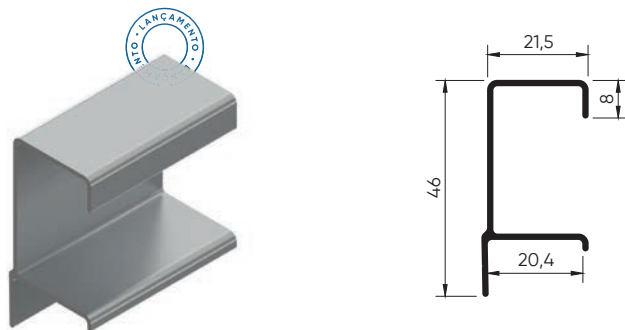

A ALUMICONTE reserva-se o direito de fazer modificações em qualquer informação escrita neste catálogo sem aviso prévio. Os desenhos aqui contidos possuem medidas teóricas de massa e tolerâncias dimensionais de acordo com a ABNT NBR-8116, podendo haver variações dessas informações no produto final.

ARMÁRIO COM ILUMINAÇÃO

Desenvolvidos para móveis de vidro com iluminação interna, esses perfis garantem montagem precisa, alta durabilidade e um visual sofisticado que transforma o ambiente.

DES-1477

Montante Traseiro Vitrine
0,952 Kg/m

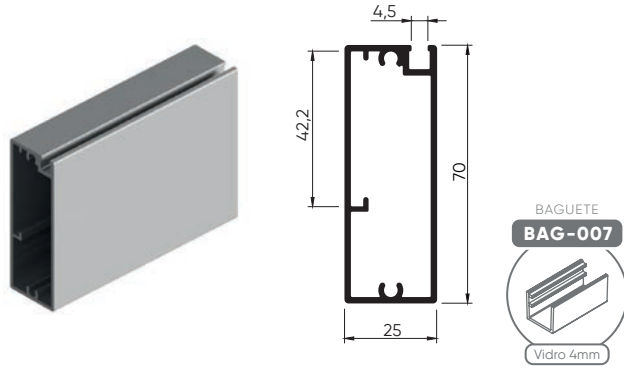

DES-1478

Montante Frontal Vitrine
0,989 Kg/m

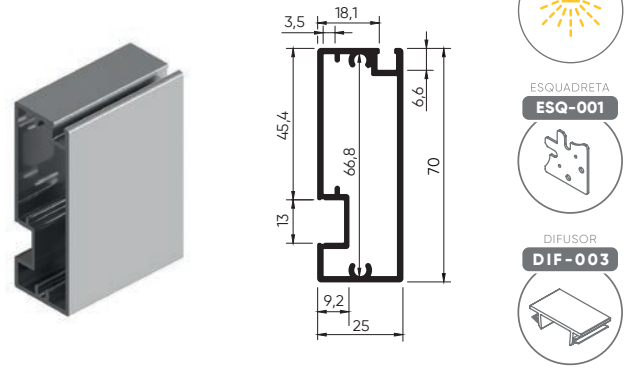

DES-1479

Montante Central Vitrine
0,943 Kg/m

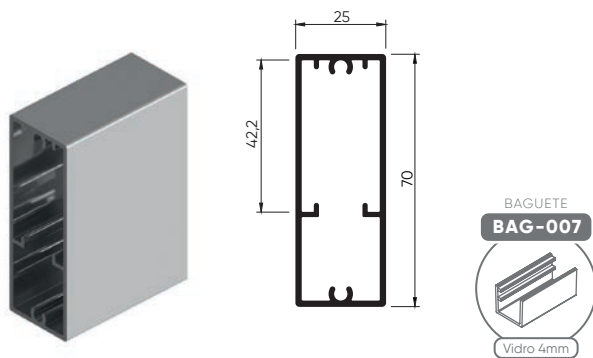

DES-1480

Montante Central Vitrine
0,991 Kg/m

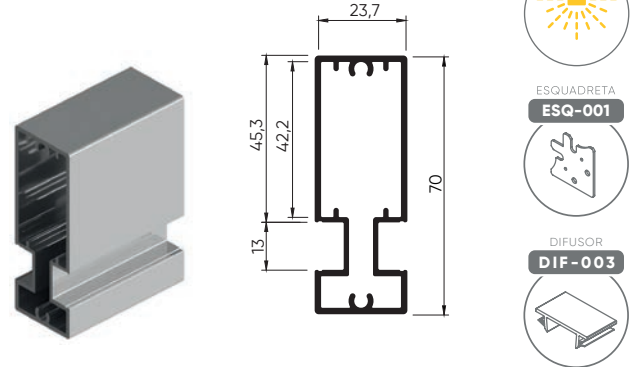

DES-1488

Quadro Prateleira
0,515 Kg/m

MONTAGEM
Indicamos o uso da esquadreta R493 da Zimac

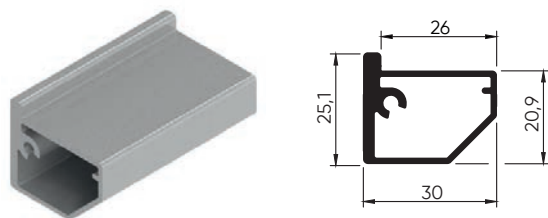

DES-1487

Quadro Prateleira
0,573 Kg/m

MONTAGEM
Indicamos o uso da esquadreta R493 da Zimac

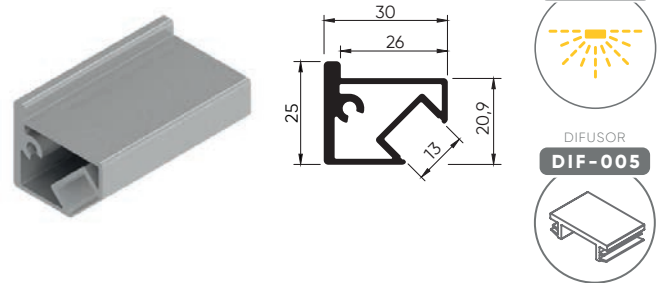

DES-161

Perfil Cabideiro
0,248 Kg/m

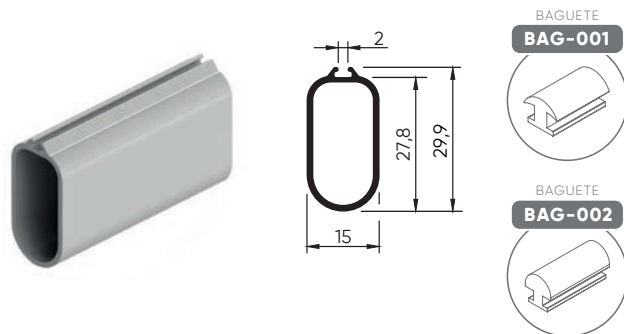

DES-1899

Perfil Cabideiro
0,291 Kg/m

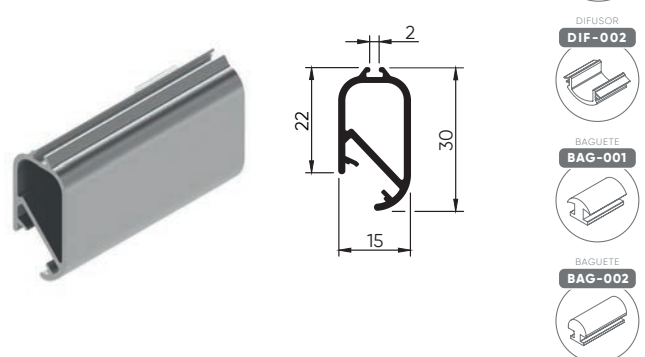

A ALUMICONTE reserva-se o direito de fazer modificações em qualquer informação escrita neste catálogo sem aviso prévio. Os desenhos aqui contidos possuem medidas teóricas de massa e tolerâncias dimensionais de acordo com a ABNT NBR-816, podendo haver variações dessas informações no produto final.

DES-600

Travessa Superior
0,810 Kg/m

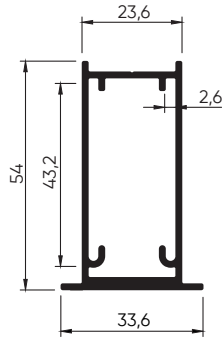
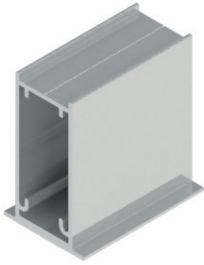

DES-1016

Travessa Quadro de Vidro
0,232 Kg/m

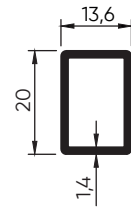

DES-1489

Requadro de Vidro com Puxador
0,684 Kg/m

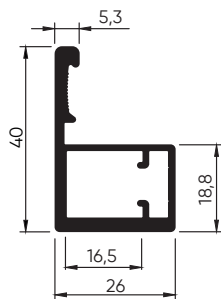

DES-1490

Quadro de Vidro
0,546 Kg/m

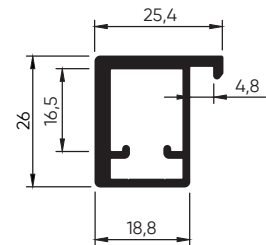

DES-1491

Quadro de Vidro com Puxador
0,644 Kg/m

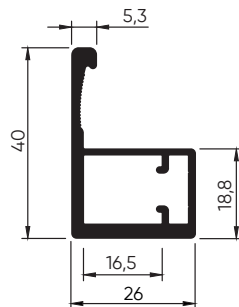

DES-1492

Quadro Pele de Vidro
0,524 Kg/m

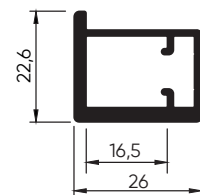

DES-3002

Puxador Dobradiça
23 mm

0,608 Kg/m

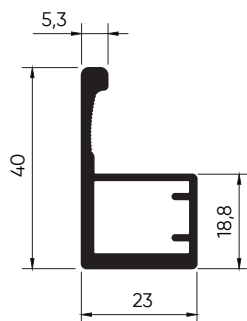

DES-2428

Quadro de Vidro
Dobradiça 23 mm

0,480 Kg/m

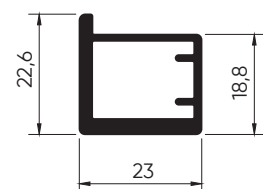

ARMÁRIO COM ILUMINAÇÃO



A ALUMICONTE reserva-se o direito de fazer modificações sem aviso prévio. Os desenhos aqui contidos possuem medidas teóricas de massa e podem variar de acordo com a ABNT NBR-816, podendo haver variações dessas informações no produto final.





PAINEL MOVIE

Indicado para esconder TVs e dispositivos eletrônicos, o Pannel Movie contribui para um ambiente mais limpo visualmente.

A ALUMICONTE reserva-se o direito de fazer modificações em qualquer informação escrita neste catálogo sem aviso prévio. Os dados aqui contidos possuem medidas teóricas de massa e tolerâncias dimensionais de acordo com a ABNT NBR 5716, podendo haver variações dessas informações em um artigo final.

DES-1298

Quadro Painei TV

2,343 Kg/m

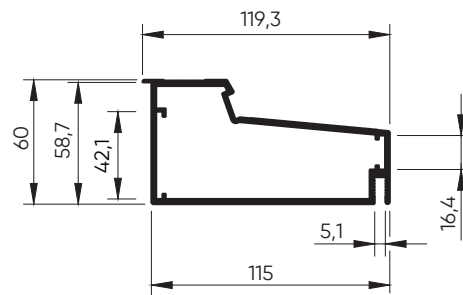
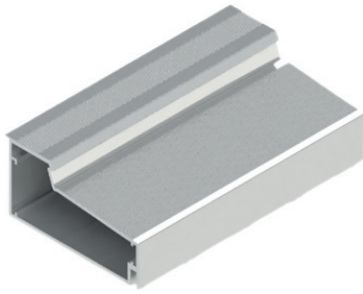

RECEBE LED



CORTE



MONTAGEM COM

ESQUADRETA



DES-1303

Quadro Painei TV

0,946 Kg/m

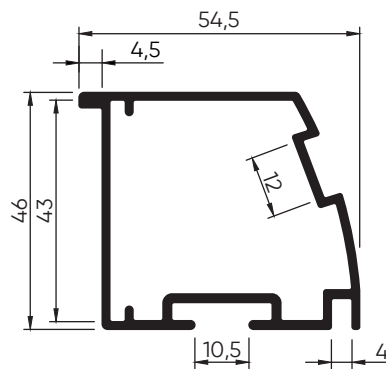

RECEBE LED



CORTE



MONTAGEM COM

ESQUADRETA



DES-851

Tubular Suporte TV - Recebe LED

1,356 Kg/m

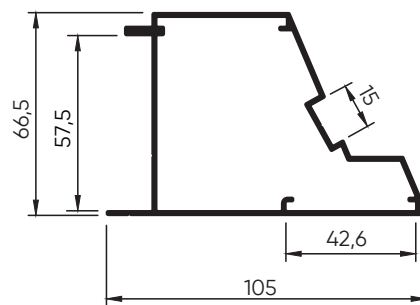

RECEBE LED



CORTE



MONTAGEM COM

ESQUADRETA



DES-852

Tubular Suporte TV - Recebe LED

0,927 Kg/m

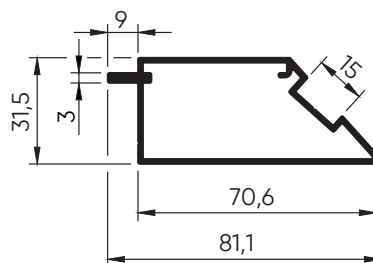

RECEBE LED



CORTE



MONTAGEM COM

ESQUADRETA



A ALUMICONTE reserva-se o direito de fazer modificações em qualquer informação escrita neste catálogo sem aviso prévio. Os desenhos aqui contidos possuem medidas teóricas e tolerâncias dimensionais de acordo com a ABNT NBR-8116, podendo haver variações dessas informações no produto final.

ALUMICONTE ÍSIS

O sistema Alumaticonte Ísis reúne perfis e componentes projetados para compor portas pivotantes com estrutura robusta, prontas para receber fechamento em:



ACM



VIDRO

Recomendação:
vidro temperado **4mm.**

Na montagem da sua porta pivotante
ALUMICONTE ÍSIS
 você vai utilizar:

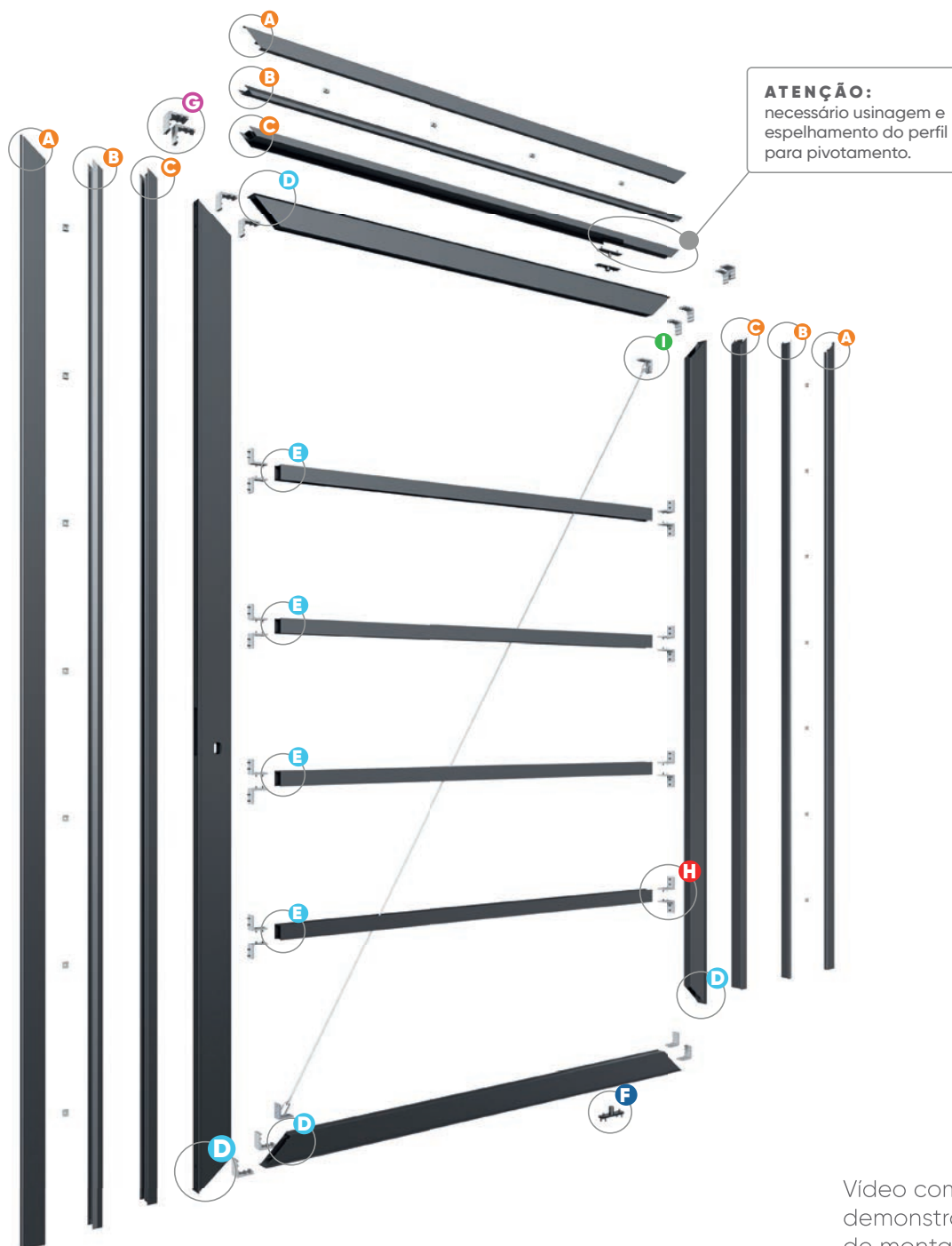

Formas de aquisição:

- Kit de perfis + componentes para porta de 2x3m - KPISIS01;
- Kit de componentes para ambos os tamanhos - KITISIS42 | KITISIS55;
- Perfis e componentes individualmente.

Video com demonstração de montagem



A ALUMICONTE reserva-se o direito de fazer modificações em qualquer informação escrita neste catálogo sem aviso prévio. Os desenhos aqui contidos possuem medidas teóricas de massa e tolerâncias dimensionais de acordo com a ABNT NBR-8116, podendo haver variações dessas informações no produto final.

ÍSIS 42 - PARA PORTAS DE ATÉ 2X3m

Estrutura externa

(marco, contramarco e arremate)

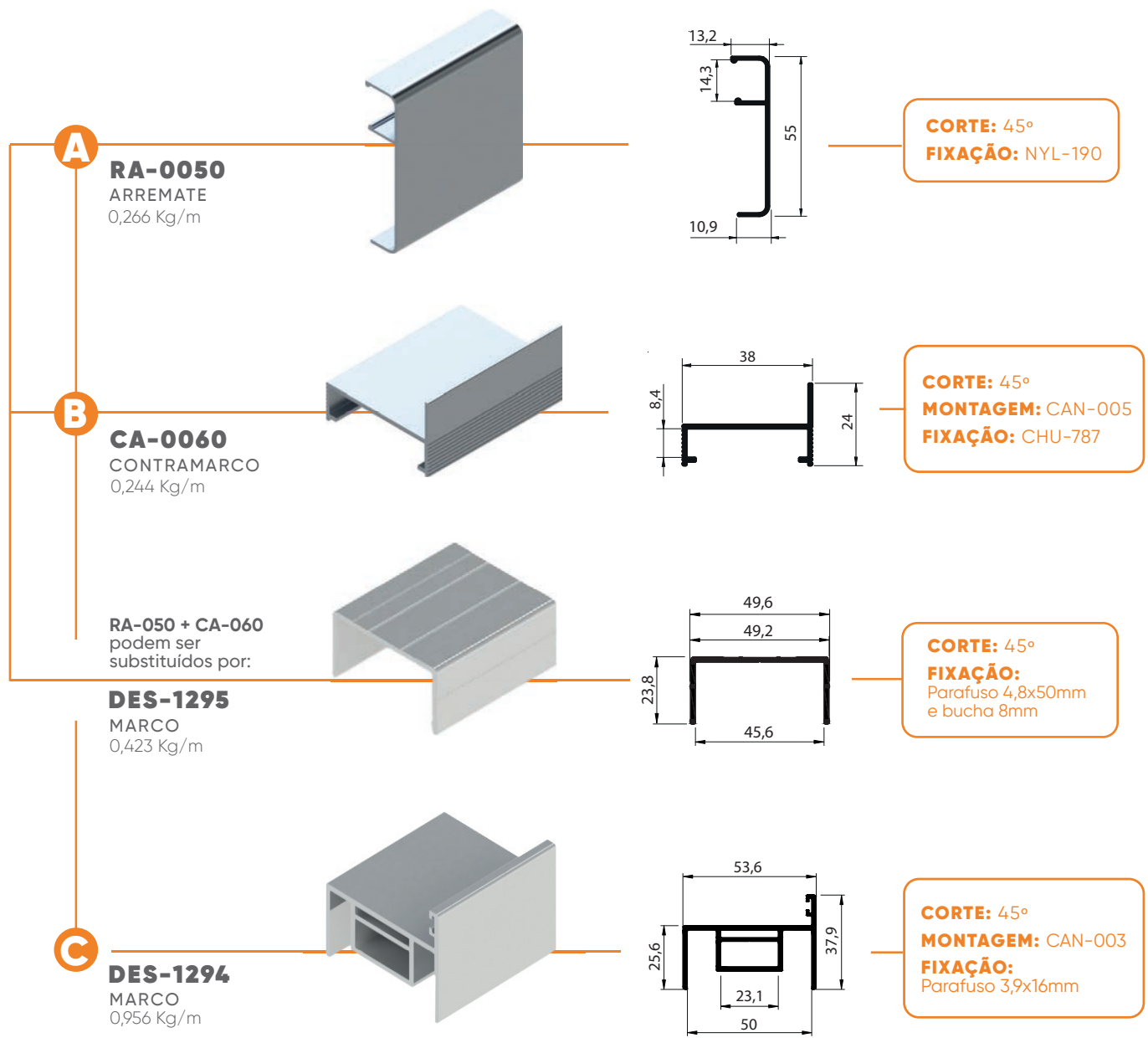

Estrutura da porta

(folha | parte móvel)

D

DES-1293
MONTANTES e
TRAVESSAS EXTERNAS
2,450 Kg/m

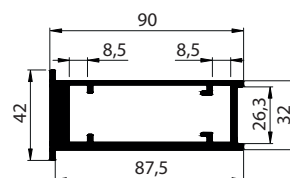
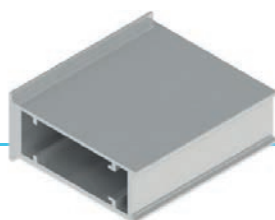

CORTE: 45°
MONTAGEM: CAN-004
FIXAÇÃO: PIV-0350IN

E

DES-1483
TRAVESSAS CENTRAIS
1,246 Kg/m

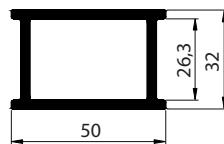
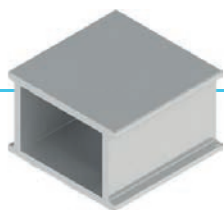

CORTE: Reto
FIXAÇÃO: CAN-008

E

DES-1482
TRAVESSAS CENTRAIS
1,280 Kg/m

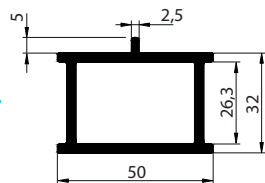
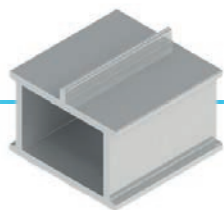

CORTE: Reto
FIXAÇÃO: CAN-008

E

DES-1481
TRAVESSAS CENTRAIS
1,314 Kg/m

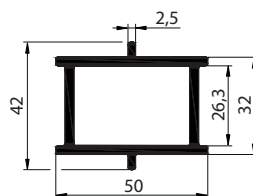

CORTE: Reto
FIXAÇÃO: CAN-008

Puxador

DES-2076
MONTANTE PUXADOR
USINADO 42 P/ LED
2,160 Kg/m

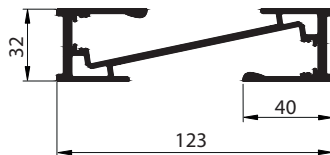
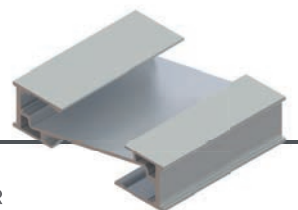

CORTE: Reto
FIXAÇÃO: CAN-008
DIFUSOR: DIF-001

Componentes | Ísis 42

F

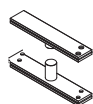

Pivô
PIV-0350IN

G

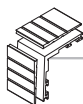

Canto e Cunha
CAN-003, CAN-004
E CAN-005

H

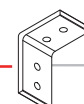

Cantoneira
CAN-008

I

Demais itens



Presilha
NYL-190



Chumbador
CHU-787



Esticador
ISIS-001



Braçadeira
ISIS-002



Cabo de Aço
ISIS-003

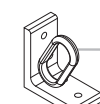

Cantoneira
CAN-009

Ísis 55 - PARA PORTAS DE ATÉ 2X5,2m

Estrutura externa

(marco, contramarco e arremate)

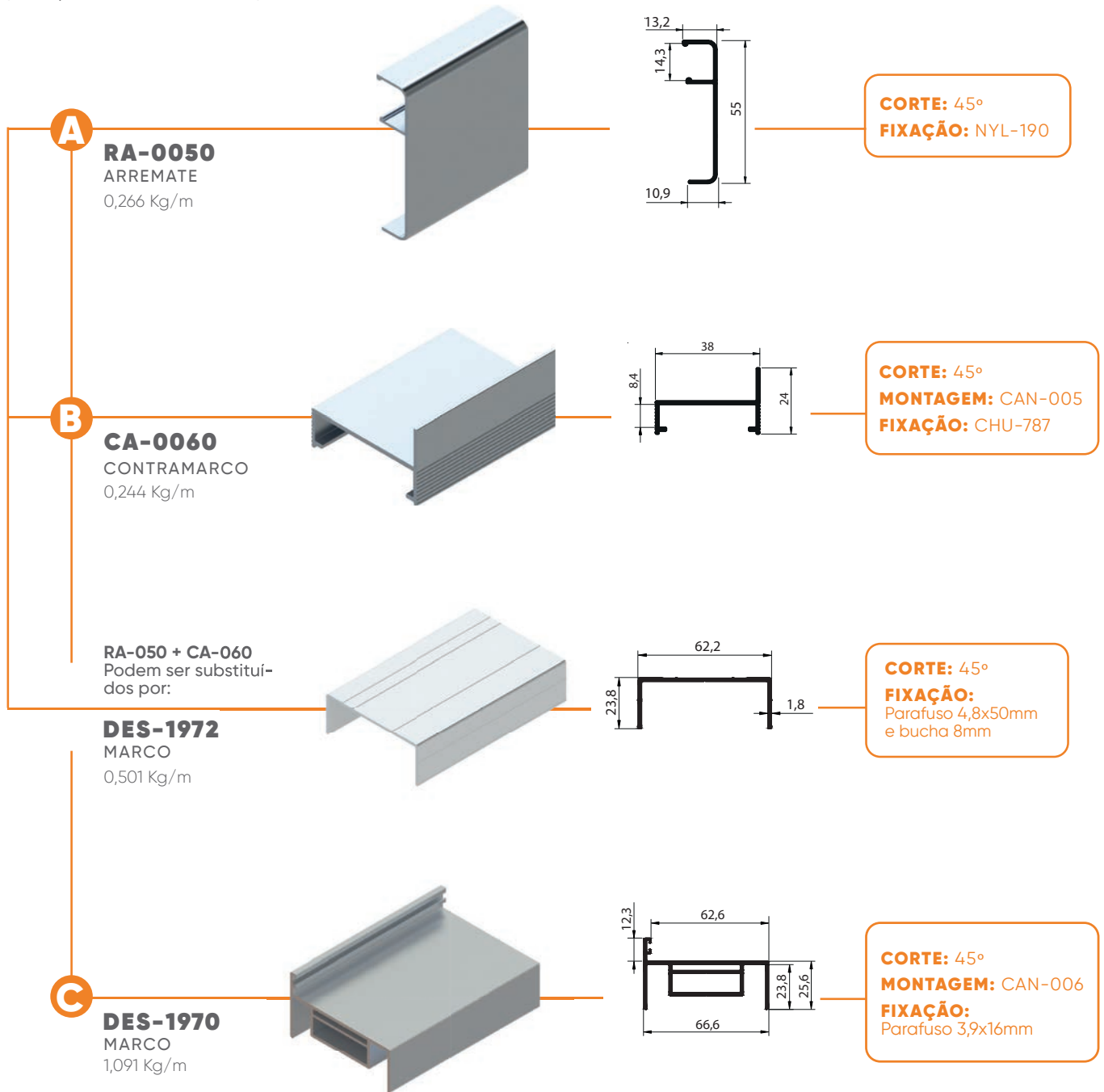



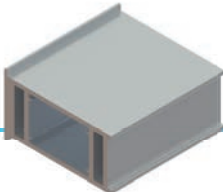
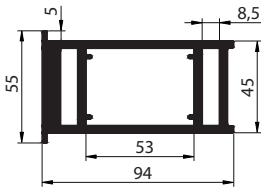
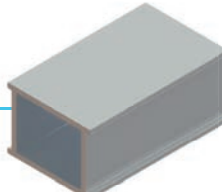
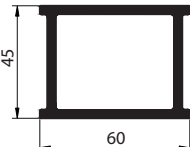
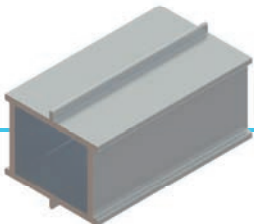
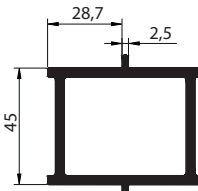
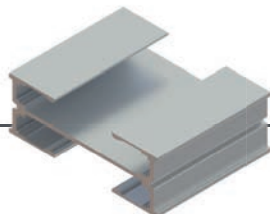
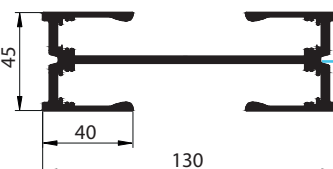

Ísis 55 - PARA PORTAS DE ATÉ 2X5,2m

Estrutura da porta

(folha | parte móvel)

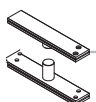
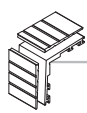
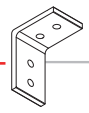
D	<p>DES-1969 MONTANTES e TRAVESSAS EXTERNAS 4,037 Kg/m</p>			<p>CORTE: 45° MONTAGEM: CAN-007 FIXAÇÃO: PIV-0350IN</p>
E	<p>DES-1998 TRAVESSAS CENTRAIS 1,799 Kg/m</p>			<p>CORTE: Reto FIXAÇÃO: CAN-010</p>
E	<p>DES-1971 TRAVESSAS CENTRAIS 1,955 Kg/m</p>			<p>CORTE: Reto FIXAÇÃO: CAN-010</p>
	<p>Puxador DES-2077 MONTANTE PUXADOR USINADO 55 P/ LED 2,954 Kg/m</p>			<p>CORTE: Reto FIXAÇÃO: CAN-010 DIFUSOR: DIF-001</p>

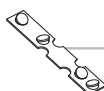
Componentes | Ísis 55

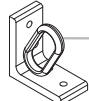
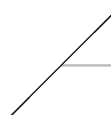
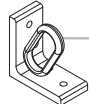
F	 <p>Pivô PIV-0350IN</p>	G	 <p>Canto e Cunha CAN-006 E CAN-007</p>	H	 <p>Cantoneira CAN-010</p>
I	Demais itens				
	 <p>Presilha NYL-190</p>	 <p>Chumbador CHU-787</p>	 <p>Esticador ISIS-001</p>		
	 <p>Braçadeira ISIS-002</p>	 <p>Cabo de Aço ISIS-004</p>	 <p>Cantoneira CAN-011</p>		

A ALUMICONTE reserva-se o direito de fazer modificações em qualquer informação escrita neste catálogo sem aviso prévio. Os desenhos aqui contidos possuem medidas teóricas de massa e tolerâncias dimensionais de acordo com a ABNT NBR-8116, podendo haver variações dessas informações no produto final.

PORTA DE PASSAGEM

Projetados para suportar portas de passagem suspensas, os perfis trilhos superiores garantem deslizamento suave, instalação prática e acabamento refinado. Ideais para dividir ambientes com leveza e modernidade, sem a necessidade de trilho inferior.

DES-036

Trilho Superior Simples
0,583 Kg/m

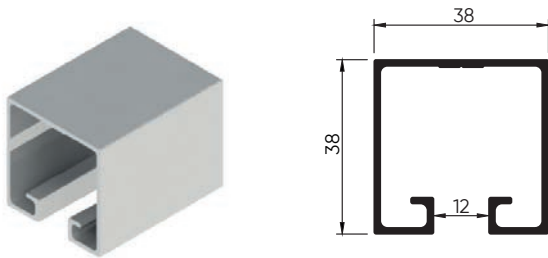

DES-037

Trilho Superior Simples (Roldana Côncava)
0,501 Kg/m

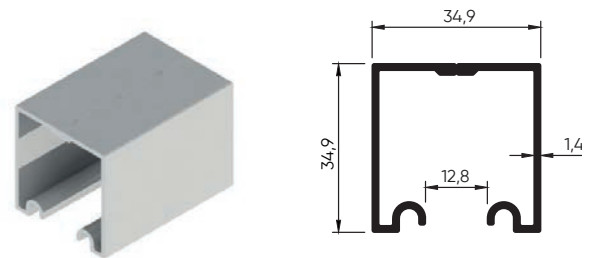

DES-044

Trilho Superior Simples (Roldana Côncava)
0,494 Kg/m

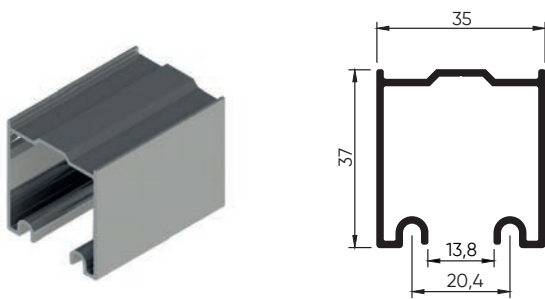

DES-200

Trilho Superior Simples (Roldana Côncava)
0,577 Kg/m

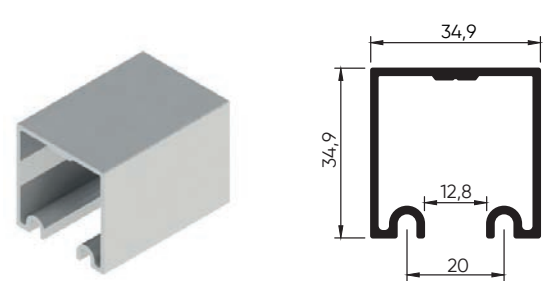

DES-261

Trilho Superior Simples com Encaixe Bandeira
0,623 Kg/m

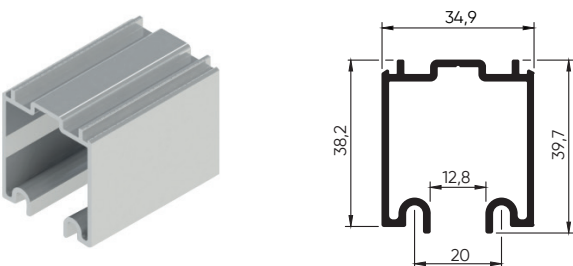

DES-167

Trilho Superior Simples (Roldana Convexa)
0,431 Kg/m

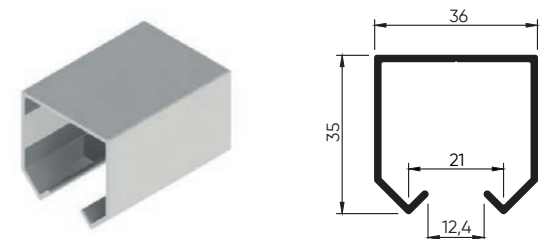

DES-039

Trilho Superior Simples (Roldana Convexa)
0,432 Kg/m

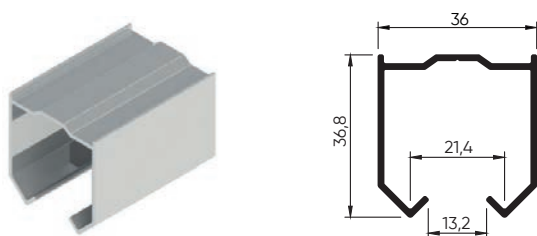

DES-886

Trilho Superior Simples (Roldana Convexa)
0,572 Kg/m

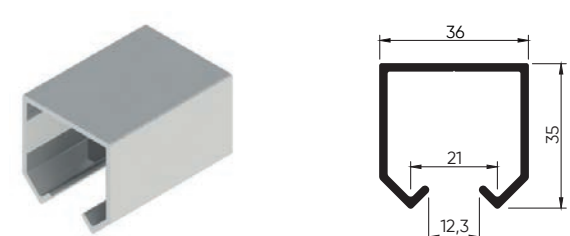

A ALUMICONTE reserva-se o direito de fazer modificações em qualquer informação escrita neste catálogo sem aviso prévio. Os desenhos aqui contidos possuem medidas teóricas de massa e tolerâncias dimensionais de acordo com a ABNT NBR-8116, podendo haver variações dessas informações no produto final.

PORTA DE PASSAGEM DE VIDRO

Soluções perfeitas para compor portas de vidro entre ambientes. Esses perfis oferecem fixação firme, visual limpo e design sofisticado, valorizando a amplitude dos espaços com praticidade e estilo.

DES-1721

Marco Regulável
0,875 Kg/m

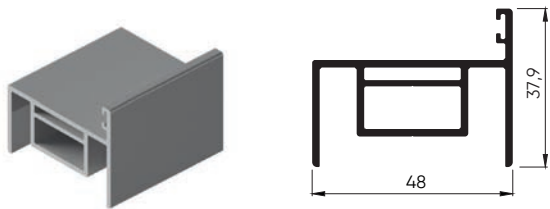

DES-1722

Estrutural Marco Regulável
0,418 Kg/m

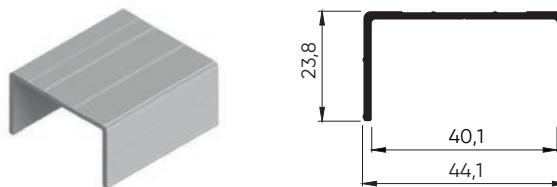

DES-1302

Marco Perimetral
0,347 Kg/m

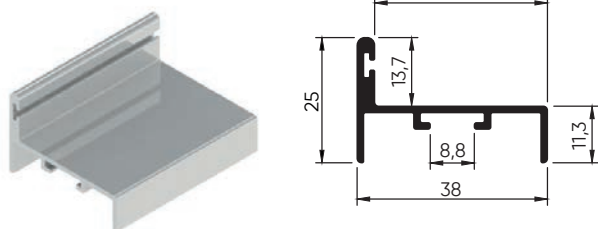

DES-1510

Montante Vidro Duplo
0,961 Kg/m

Compatível • MONTAGEM
DES-1512 | DES-1514

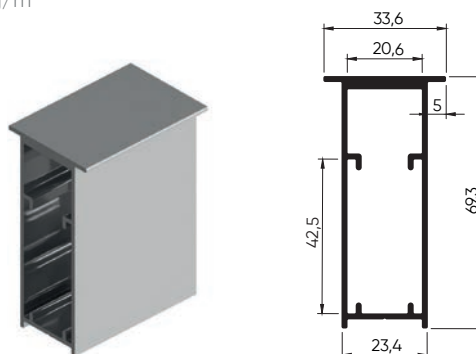

DES-1512

Travessa Vidro Duplo
0,987 Kg/m

Compatível • MONTAGEM
DES-1510 | DES-1511 | DES-1514

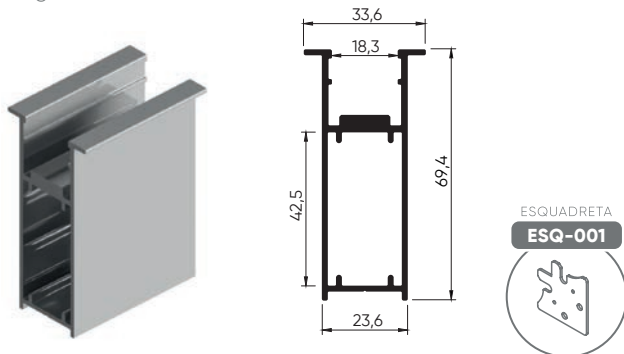

DES-1511

Montante Vidro Duplo
0,961 Kg/m

Compatível • MONTAGEM
DES-1510 | DES-1512 | DES-1514

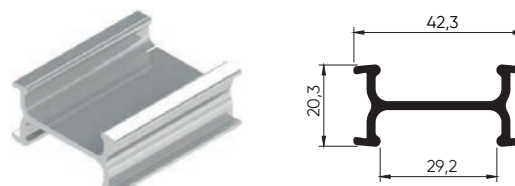

DES-1514

Travessa Divisória
0,532 Kg/m

Compatível • MONTAGEM
DES-1510 | DES-1511 | DES-1512

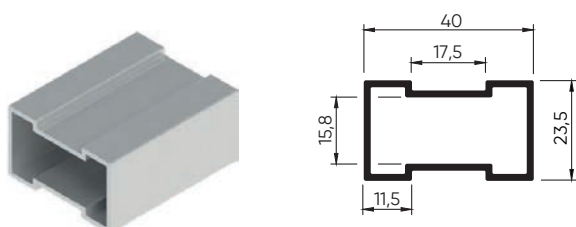

BXT-505

Fixação Travessa
0,467 Kg/m

Compatível • MONTAGEM
DES-1514

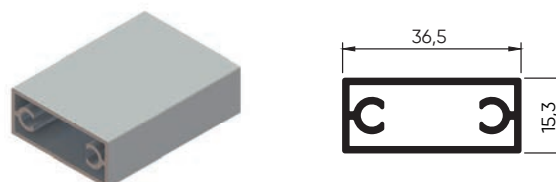

A ALUMICONTE reserva-se o direito de fazer modificações em qualquer informação escrita neste catálogo sem aviso prévio. Os desenhos aqui contidos possuem medidas teóricas de massa e tolerâncias dimensionais de acordo com a ABNT NBR-8116, podendo haver variações dessas informações no produto final.

DES-599

Travessa Inferior Divisória de Ambiente
0,758 Kg/m

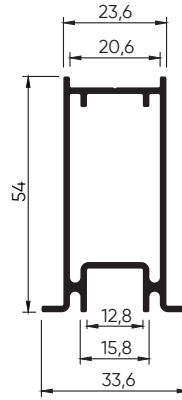
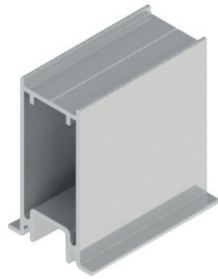

Compatível • MONTAGEM

DES-597 | DES-599 | DES-600 | DES-2344

DES-597

Travessa Intermediária Dupla
0,533 Kg/m

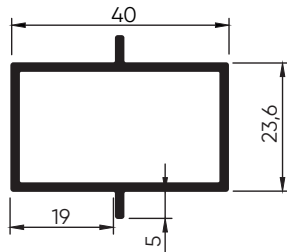
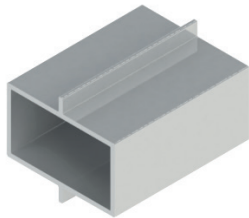

Compatível • MONTAGEM
DES-598 | DES-599
DES-600 | DES-2344

DES-598

Travessa Intermediária
0,513 Kg/m

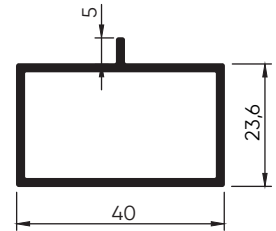

Compatível • MONTAGEM

DES-597 | DES-599 | DES-600 | DES-2344

DES-600

Travessa Superior Divisória de Ambiente
0,810 Kg/m

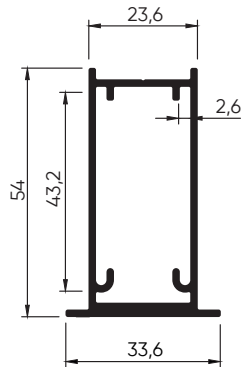
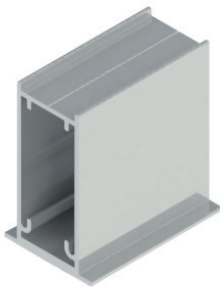

Compatível • MONTAGEM
DES-597 | DES-598 | DES-599 | DES-2344

DES-2344

Arremate de Folha
0,202 Kg/m

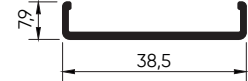
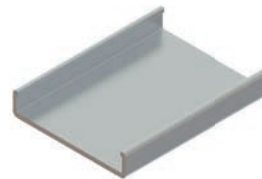

Compatível • MONTAGEM

DES-597 | DES-598
DES-599 | DES-600

DES-2343

Batente para Porta de Correr
0,788 Kg/m

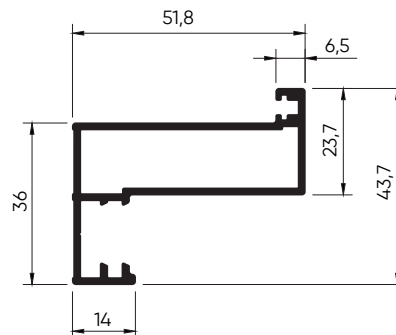
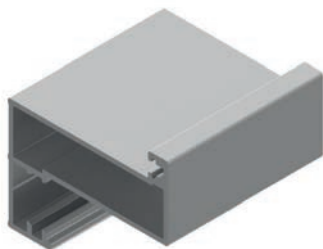

RECEBE LED



DIFUSOR

DIF-001



A ALUMICONTE reserva-se o direito de fazer modificações em qualquer informação escrita neste catálogo sem aviso prévio. Os desenhos aqui contidos possuem medidas teóricas de massa e tolerâncias dimensionais de acordo com a ABNT NBR-8116, podendo haver variações dessas informações no produto final.

DES-1517

Montante Vidro Duplo
0,738 Kg/m

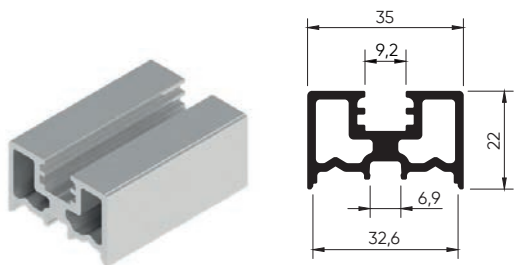

BAGUETE
BAG-003

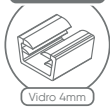

BAGUETE
BAG-015

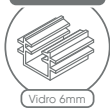

DES-1518

Capa Montante
0,140 Kg/m

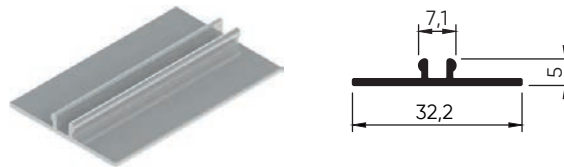

DES-1519

Travessa Divisória
0,783 Kg/m

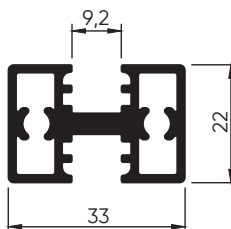
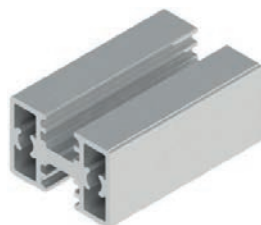

BAGUETE
BAG-003



BAGUETE
BAG-015



DES-1516

Travessa Sup./Inf. Vidro Duplo
0,851 Kg/m

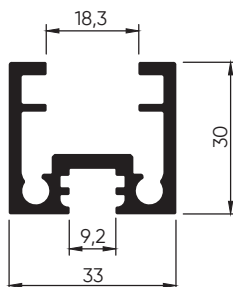

ADP-1516

Adaptador para porta de passagens



BAGUETE
BAG-003



BAGUETE
BAG-015



DES-1526

Perfil Travessa Superior
0,962 Kg/m

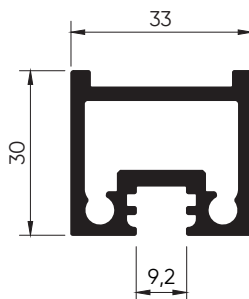

BAGUETE
BAG-003



BAGUETE
BAG-015



A ALUMICONTE reserva-se o direito de fazer modificações em qualquer informação escrita neste catálogo sem aviso prévio. Os desenhos aqui contidos possuem medidas teóricas de massa e tolerâncias dimensionais de acordo com a ABNT NBR-8116, podendo haver variações dessas informações no produto final.

PORTA DE CORRER

Perfis que garantem o deslizamento suave e estável das portas de correr, com encaixe preciso e acabamento moderno para armários funcionais e elegantes.

DES-035

Trilho Superior Simples
0,387 Kg/m

Compatível • MONTAGEM
DES-041 | DES-055
DES-155 | DES-315

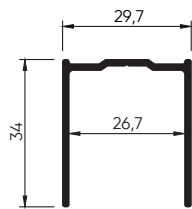
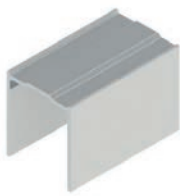

DES-944

Trilho Superior Simples
0,317 Kg/m

Compatível • MONTAGEM
DES-041 | DES-055
DES-155 | DES-315

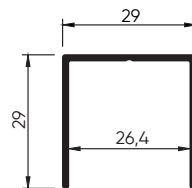
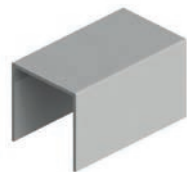

DES-1433

Trilho Superior Simples
0,545 Kg/m

Compatível • MONTAGEM
DES-041 | DES-055
DES-155 | DES-315

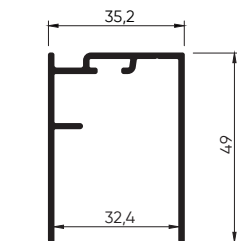

DES-980

Trilho Superior Simples
0,301 Kg/m

Compatível • MONTAGEM
DES-041 | DES-055
DES-155 | DES-315

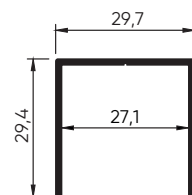

DES-992

Trilho Superior Simples
0,249 Kg/m

Compatível • MONTAGEM
DES-041 | DES-055
DES-155 | DES-315

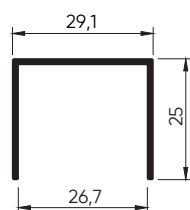
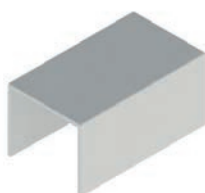

DES-041

Trilho Inferior Simples
0,124 Kg/m

Compatível • MONTAGEM
DES-035 | DES-944 | DES-1433
DES-980 | DES-992

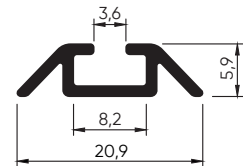
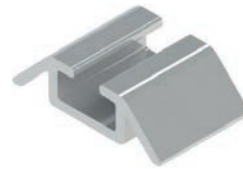

DES-055

Trilho Inferior Simples de Embutir
0,088 Kg/m

Compatível • MONTAGEM
DES-035 | DES-944 | DES-1433
DES-980 | DES-992

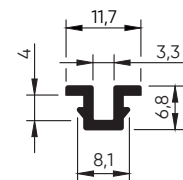

DES-155

Trilho Inferior Simples
0,085 Kg/m

Compatível • MONTAGEM
DES-035 | DES-944 | DES-1433
DES-980 | DES-992

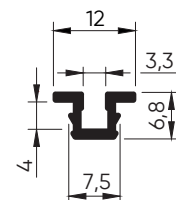

DES-315

Trilho Inferior Simples de Embutir
0,110 Kg/m

Compatível • MONTAGEM
DES-035 | DES-944 | DES-1433
DES-980 | DES-992

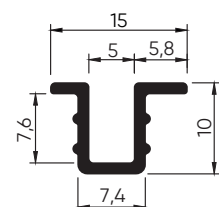

A ALUMICONTE reserva-se o direito de fazer modificações em qualquer informação escrita neste catálogo sem aviso prévio. Os desenhos aqui contidos possuem medidas teóricas de massa e tolerâncias dimensionais de acordo com a ABNT NBR-8116, podendo haver variações dessas informações no produto final.

DES-038

Trilho Superior Duplo
0,492 Kg/m



Compatível • MONTAGEM
DES-113 | DES-294 | DES-512 | DES-058

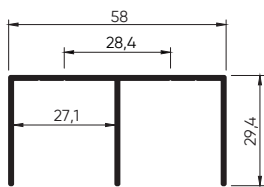

DES-156

Trilho Superior Duplo
0,435 Kg/m



Compatível • MONTAGEM
DES-113 | DES-294 | DES-512 | DES-058

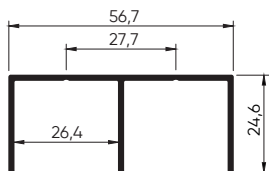

DES-390

Trilho Superior Duplo
0,441 Kg/m

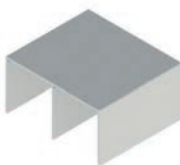

Compatível • MONTAGEM
DES-113 | DES-294 | DES-512 | DES-058

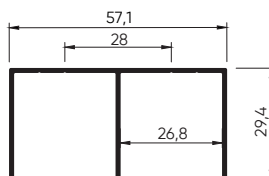

DES-287

Trilho Superior Duplo Aba Convexa
0,589 Kg/m

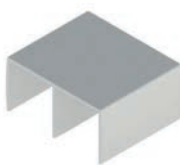

Compatível • MONTAGEM
DES-113 | DES-294
DES-512 | DES-058

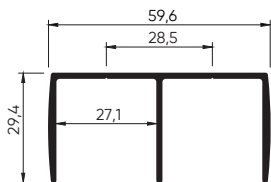

DES-511

Trilho Superior Duplo
0,465 Kg/m

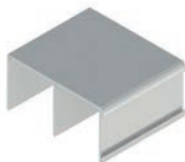

Compatível • MONTAGEM
DES-113 | DES-294 | DES-512 | DES-058

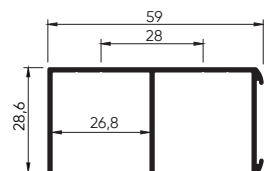

DES-524

Trilho Superior Duplo
0,393 Kg/m



Compatível • MONTAGEM
DES-113 | DES-294 | DES-512 | DES-058

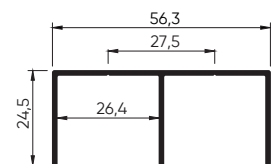

DES-113

Trilho Inferior Duplo
0,232 Kg/m

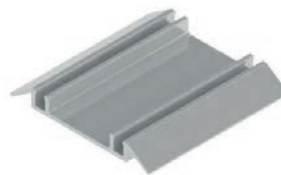

Compatível • MONTAGEM
DES-038 | DES-156 | DES-390
DES-287 | DES-511 | DES-524

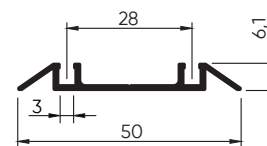

DES-294

Trilho Inferior Duplo
0,275 Kg/m

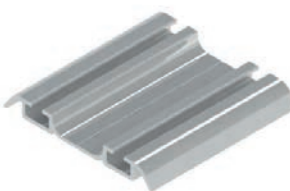

Compatível • MONTAGEM
DES-038 | DES-156 | DES-390
DES-287 | DES-511 | DES-524

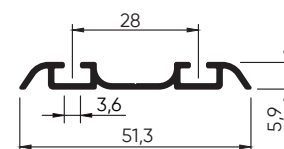

DES-512

Trilho Inferior Duplo
0,231 Kg/m



Compatível • MONTAGEM
DES-038 | DES-156 | DES-390
DES-287 | DES-511 | DES-524

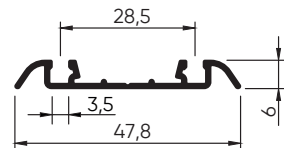

DES-058

Trilho Inferior Duplo
0,249 Kg/m

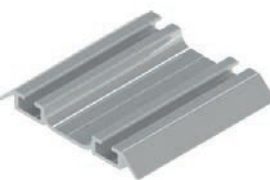

Compatível • MONTAGEM
DES-038 | DES-156 | DES-390
DES-287 | DES-511 | DES-524

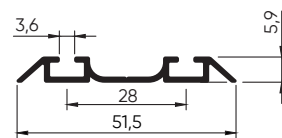

A ALUMICONTE reserva-se o direito de fazer modificações em qualquer informação escrita neste catálogo sem aviso prévio. Os desenhos aqui contidos possuem medidas teóricas de massa e tolerâncias dimensionais de acordo com a ABNT NBR-8116, podendo haver variações dessas informações no produto final.

DES-032

Trilho Superior Duplo
0,665 Kg/m

Compatível • MONTAGEM
DES-228 | DES-051

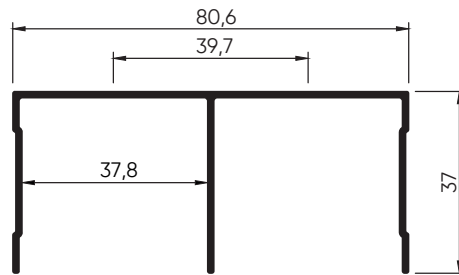
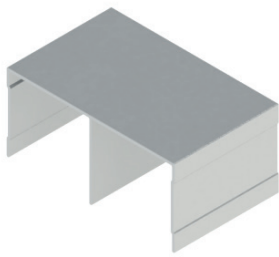

DES-228

Trilho Inferior Duplo
0,213 Kg/m

Compatível • MONTAGEM
DES-032



DES-051

Trilho Inferior Duplo
0,302 Kg/m

Compatível • MONTAGEM
DES-032

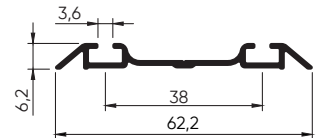
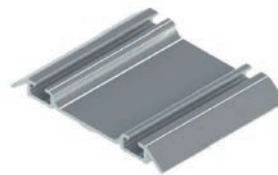

DES-1434

Trilho Superior Duplo
0,910 Kg/m

Compatível • MONTAGEM
DES-344 | DES-603 | DES-843

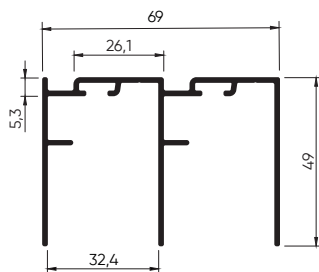
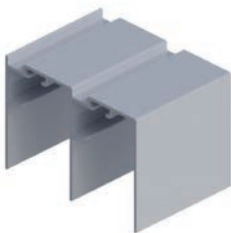

DES-344

Trilho Inferior Duplo
0,294 Kg/m

Compatível • MONTAGEM
DES-1434 | DES-601

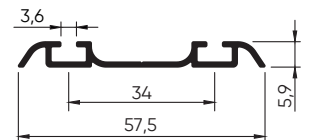

DES-601

Trilho Superior Duplo
0,534 Kg/m

Compatível • MONTAGEM
DES-344 | DES-603 | DES-843

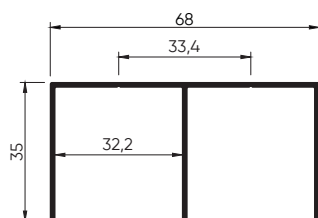

DES-603

Trilho Inferior Duplo
0,238 Kg/m

Compatível • MONTAGEM
DES-1434 | DES-601

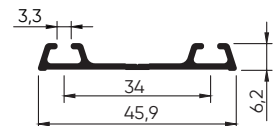
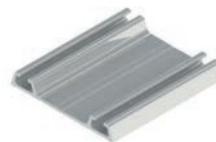

DES-843

Trilho Inferior Duplo
0,257 Kg/m

Compatível • MONTAGEM
DES-1434 | DES-601

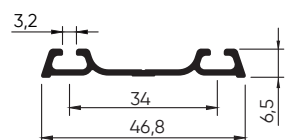

A ALUMICONTE reserva-se o direito de fazer modificações em qualquer informação escrita neste catálogo sem aviso prévio. Os desenhos aqui contidos possuem medidas teóricas de massa e tolerâncias dimensionais de acordo com a ABNT NBR-8116, podendo haver variações dessas informações no produto final.

DES-844

Trilho Superior Duplo
0,461 Kg/m

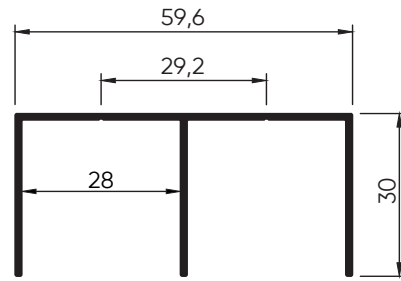
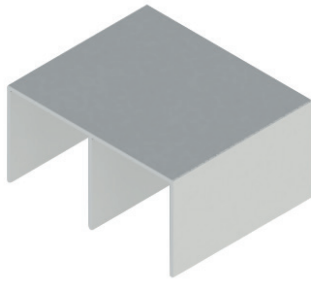

Compatível • MONTAGEM
DES-042 | DES-188 | DES-309
DES-820 | DES-1284

DES-042

Trilho Inferior Duplo
0,235 Kg/m

Compatível • MONTAGEM
DES-844

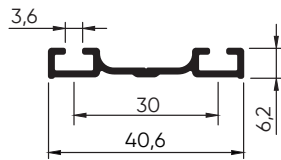

DES-188

Trilho Inferior Duplo
0,337 Kg/m

Compatível • MONTAGEM
DES-844

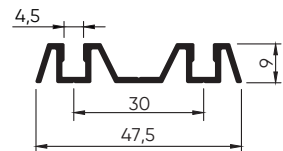

DES-309

Trilho Inferior Duplo
0,267 Kg/m

Compatível • MONTAGEM
DES-844

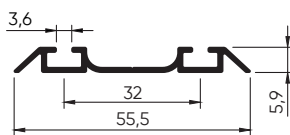
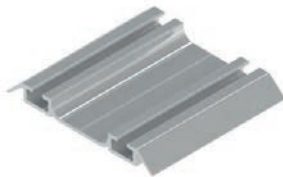

DES-820

Trilho Inferior Duplo
0,295 Kg/m

Compatível • MONTAGEM
DES-844

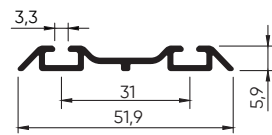
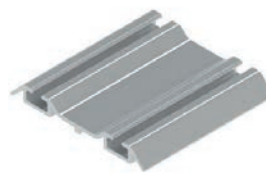

DES-1284

Trilho Inferior Duplo
0,288 Kg/m

Compatível • MONTAGEM
DES-844

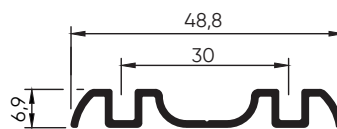
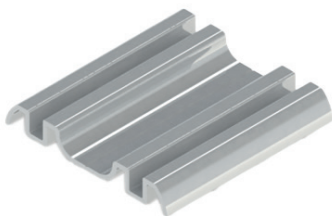

A ALUMICONTE reserva-se o direito de fazer modificações em qualquer informação escrita neste catálogo sem aviso prévio. Os desenhos aqui contidos possuem medidas teóricas de massa e tolerâncias dimensionais de acordo com a ABNT NBR-8116, podendo haver variações dessas informações no produto final.

DES-334

Montante Puxador Porta de Correr

0,613 Kg/m

Compatível • MONTAGEM
DES-257 | DES-260

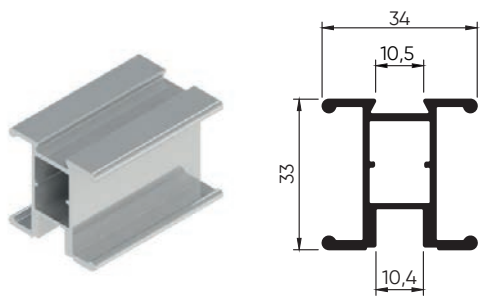

DES-259

Montante Puxador Porta de Correr

0,680Kg/m

Compatível • MONTAGEM
DES-257 | DES-258 | DES-260

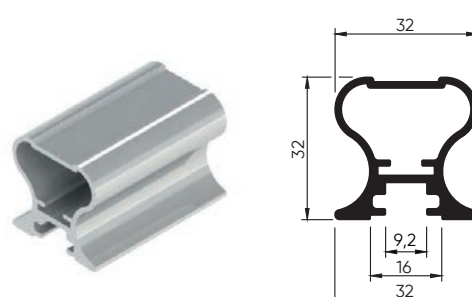

DES-257

Travessa Inferior para Porta Deslizante

0,594 Kg/m

Compatível • MONTAGEM
DES-258 | DES-260

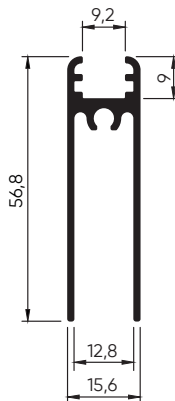
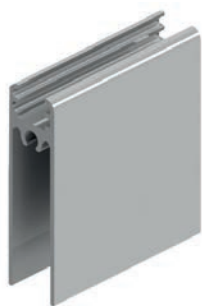

DES-260

Travessa Superior 8mm

0,749 Kg/m

Compatível • MONTAGEM
DES-258 | DES-257

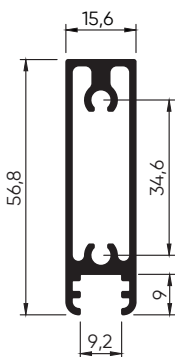

DES-258

Travessa Intermediária Porta de Correr

0,491 Kg/m

Compatível • MONTAGEM
DES-257 | DES-260

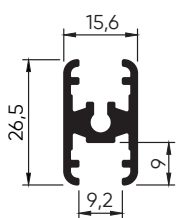

DES-874

Travessa Superior/Inferior Porta de Correr

0,279 Kg/m

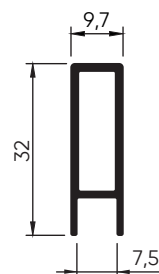

A ALUMICONTE reserva-se o direito de fazer modificações em qualquer informação escrita neste catálogo sem aviso prévio. Os desenhos aqui contidos possuem medidas teóricas de massa e tolerâncias dimensionais de acordo com a ABNT NBR-8116, podendo haver variações dessas informações no produto final.

DES-1445
Montante Estrutural
0,758 Kg/m

Compatível • MONTAGEM
DES-1413

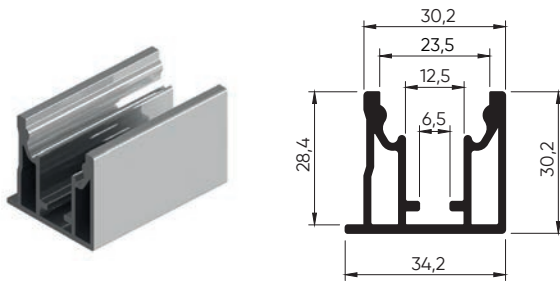

DES-1412
Montante Estrutural
0,724 Kg/m

Compatível • MONTAGEM
DES-1413

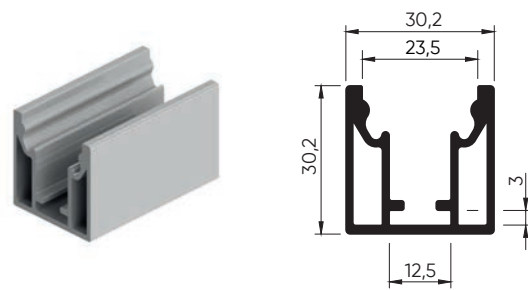

DES-1413
Capa Montante Estrutural
0,209 Kg/m

Compatível • MONTAGEM
DES-1412 | DES-1445

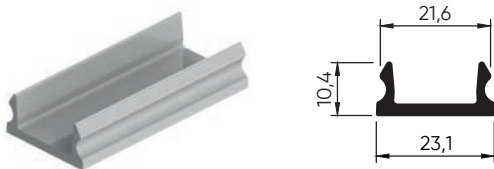

DES-932
Estrutural Vitrine
1,081 Kg/m

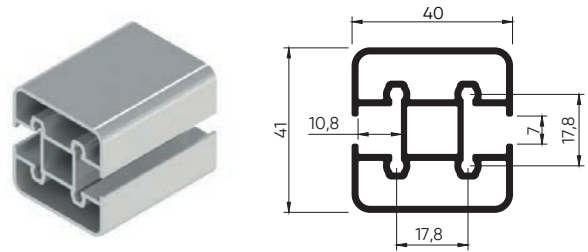

DES-1304
Quadro do Vidro Sistema Prateleira LED
0,709 Kg/m

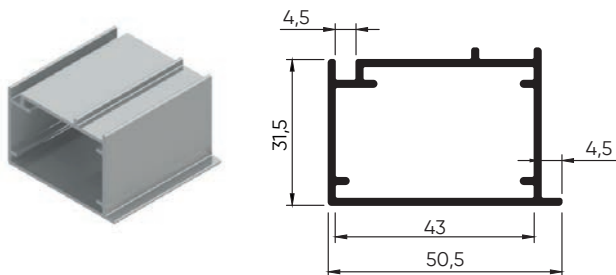

DES-400
Estrutural Industrial 100x30
1,858 Kg/m

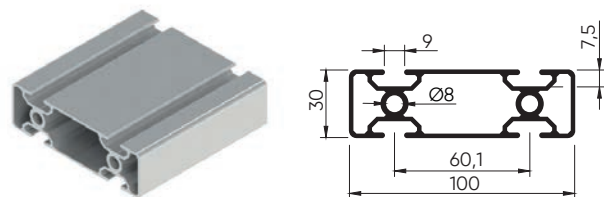

DES-1409
Quadro Prateleira LED
0,470 Kg/m

Compatível • MONTAGEM
DES-1410 | DES-1411

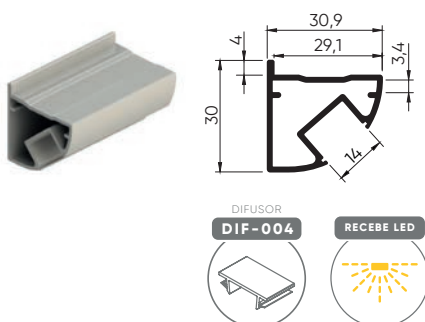

DES-1410
Quadro Prateleira
0,396 Kg/m

Compatível • MONTAGEM
DES-1409 | DES-1411

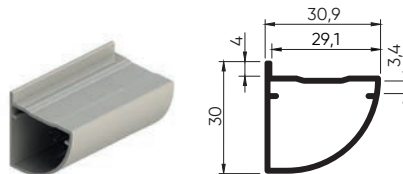

DES-1411
Quadro Lateral Prateleira
0,445 Kg/m

Compatível • MONTAGEM
DES-1409 | DES-1410

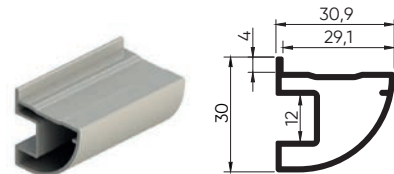

A ALUMICONTE reserva-se o direito de fazer modificações em qualquer informação escrita neste catálogo sem aviso prévio. Os desenhos aqui contidos possuem medidas teóricas de massa e tolerâncias dimensionais de acordo com a ABNT NBR-8116, podendo haver variações dessas informações no produto final.

DES-248

Testeira Perimetral 18mm
0,207 Kg/m

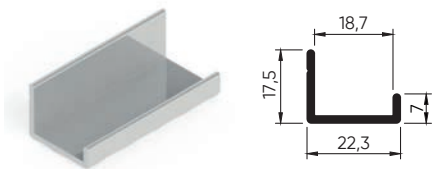

DES-249

Testeira Perimetral 15mm
0,193 Kg/m

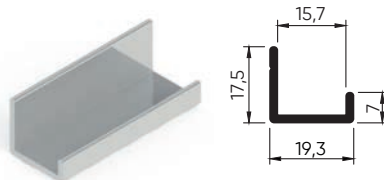

DES-2639

Testeira Perimetral 15mm
0,108 Kg/m

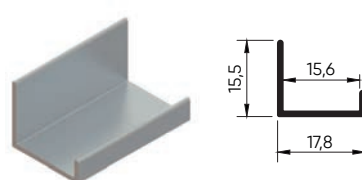

DES-292

Testeira Perimetral 18mm
0,256 Kg/m

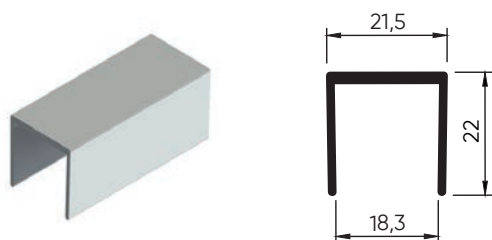

DES-165

Trilho/Testeira 15mm
0,277 Kg/m

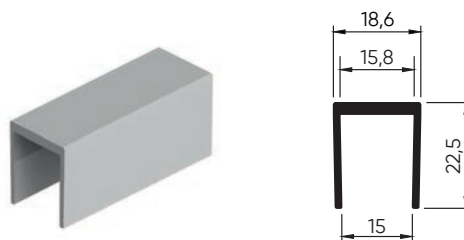

DES-205

Trilho/Testeira 15mm
0,371 Kg/m

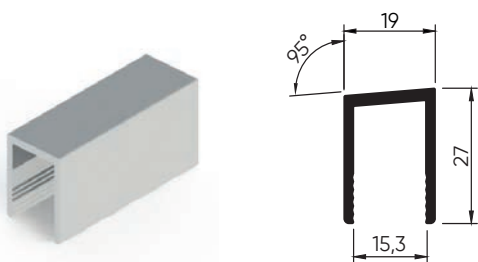

DES-596

Testeira 15mm
0,283 Kg/m

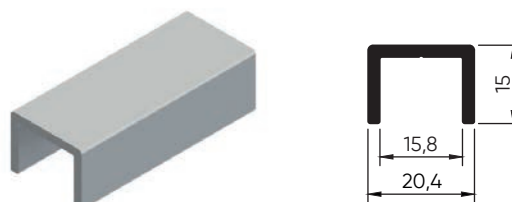

DES-171

Perfil "U" 29x14mm
0,218 Kg/m



A ALUMICONTE reserva-se o direito de fazer modificações em qualquer informação escrita neste catálogo sem aviso prévio. Os desenhos aqui contidos possuem medidas teóricas de massa e tolerâncias dimensionais de acordo com a ABNT NBR-8116, podendo haver variações dessas informações no produto final.

DES-694

Testeira Perimetral 18mm
0,165 Kg/m

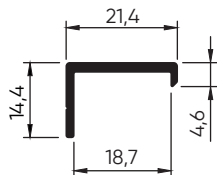
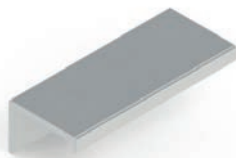

DES-1620

Testeira Perimetral 15mm
0,146 Kg/m

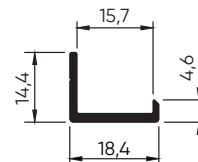

DES-241

Testeira Perimetral com Espiga 18mm
0,172 Kg/m

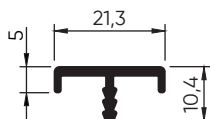
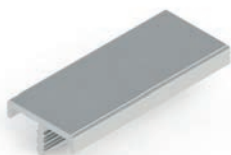

DES-240

Testeira Perimetral com Espiga 15mm
0,157 Kg/m

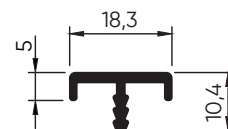
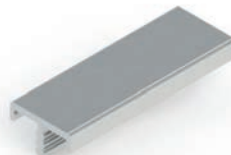

DES-2090

Perfil Divisor "H" 18mm
0,552 Kg/m

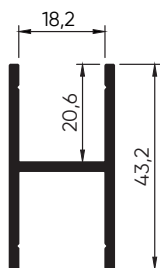
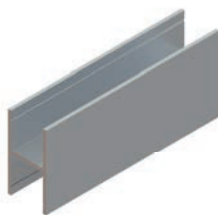

DES-2089

Perfil Divisor "H" 15mm
0,533 Kg/m

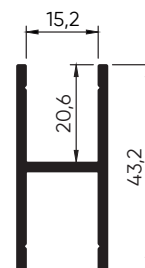
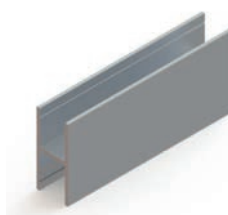

DES-616

Testeira Perimetral 18mm
0,713 Kg/m

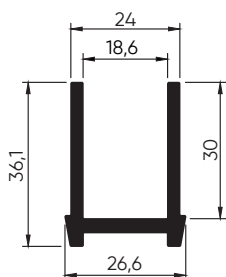

DES-1281

Estrutural Boleado
0,944 Kg/m

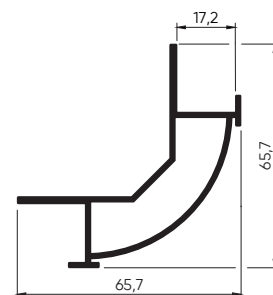

A ALUMICONTE reserva-se o direito de fazer modificações em qualquer informação escrita neste catálogo sem aviso prévio. Os desenhos aqui contidos possuem medidas teóricas de massa e tolerâncias dimensionais de acordo com a ABNT NBR-8116, podendo haver variações dessas informações no produto final.

DES-3005

Canto MDF 15 com Borda
0,518 Kg/m

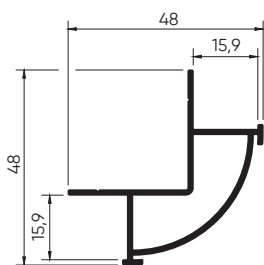
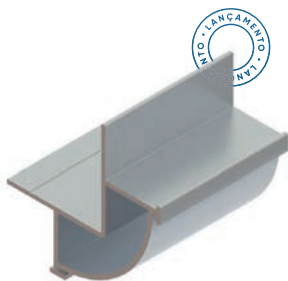

Demonstração de montagem



DES-3006

Canto MDF 15 sem Borda
0,576 Kg/m

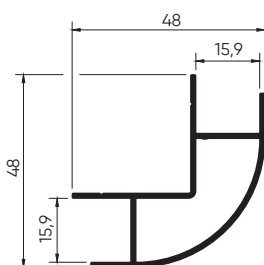
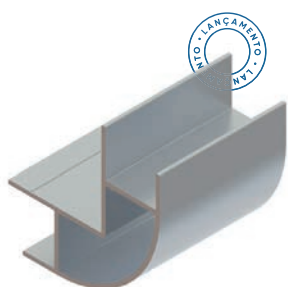

Demonstração de montagem



DES-3007

Canto MDF 18 sem Borda
0,576 Kg/m

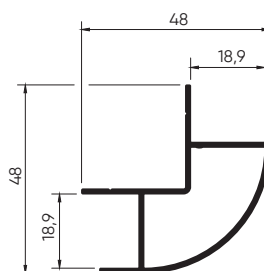
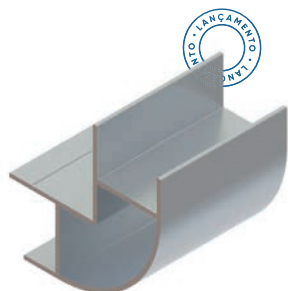

Demonstração de montagem em móveis para motorhome.
PERFIL DES-3006

RIPADOS

Sofisticação em cada detalhe. Perfis ripados com design contemporâneo para composições elegantes e cheias de personalidade.



Perfil Lambri
Cód.: ALV-2513

ALUMICONTE
sensorial

Uma coleção que traz perfis com geometrias exclusivas, desenhadas para despertar emoções e transformar ambientes através das sensações.

Perfil Ripado Sensia
Cód.: ALV-2585



Perfil Ripado Visia
Cód.: ALV-2583



AVULGOSAMENTE NÃO SE DEVE DIREITO DE TER MOCHILAS, INCLUIÇÃO DE INFORMAÇÕES, ESTILO, CATEGORIA, SEM AVISO PRÉVIO. OS DESENHOS AQUI MOSTRADOS SÃO APENAS PARA ILUSTRAÇÃO E NÃO REPRESENTAM O PRODUTO FINAL. OS DESENHOS AQUI MOSTRADOS SÃO APENAS PARA ILUSTRAÇÃO E NÃO REPRESENTAM O PRODUTO FINAL.

ALV-2582

Perfil Ripado Tacta | Passo 120 mm

0,660 Kg/m

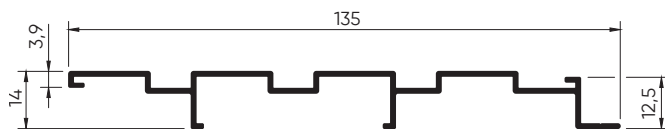
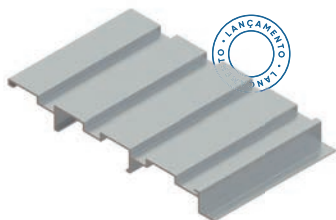
**ALV-2583**

Perfil Ripado Visia | Passo 118 mm

0,735 Kg/m

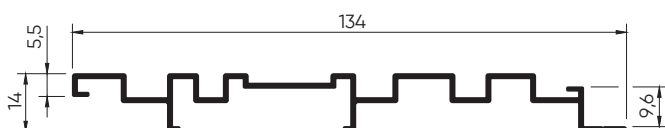
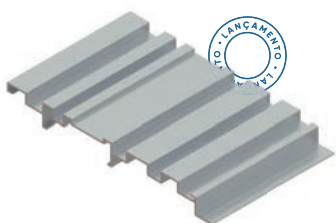
**ALV-2584**

Perfil Ripado Ecoar | Passo 120 mm

0,647 Kg/m

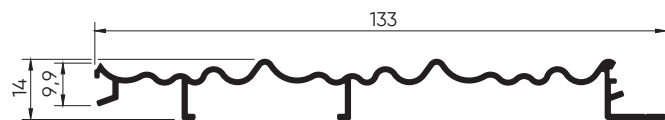
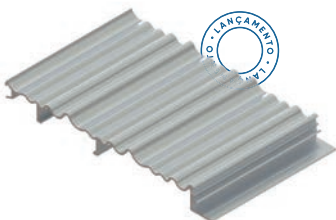
**ALV-2585**

Perfil Ripado Sensia | Passo 90 mm

0,554 Kg/m

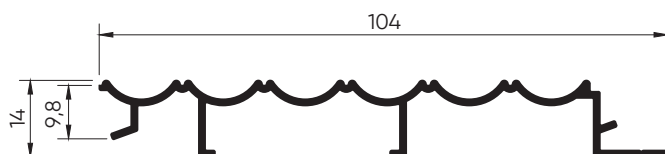
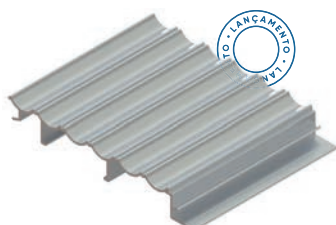

ALUMICONTE
sensorial

Perfil Ripado Tacta
Cód.: ALV-2582

A ALUMICONTE reserva-se o direito de fazer modificações em qualquer informação escrita neste catálogo sem aviso prévio. Os desenhos aqui contidos possuem medidas aproximadas e não representam a massa e as dimensões dimensionais de acordo com o ABNT NBR-8116, podendo haver variações dessas informações no produto final.



Perfil Ripado Ecoar
Cód.: ALV-2584



ALV-2513

Perfil Lambri Contemporâneo | Passo 73mm

0,708Kg/m

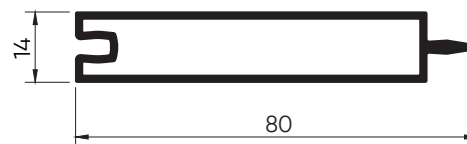
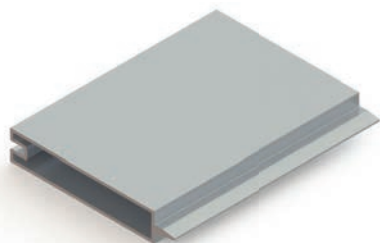
**DES-1290**

Ondulado 72 X 3,6 mm

0,291 Kg/m

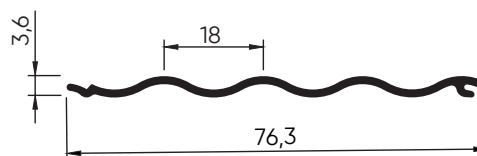
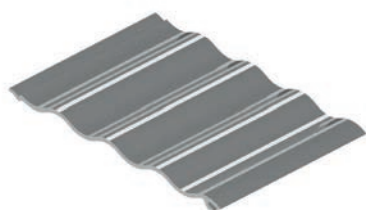

Perfil Lambri
Cód.: DES-1290

ALV-2511

Lambri Ripado | Passo 135mm | Recebe LED

1,017 Kg/m

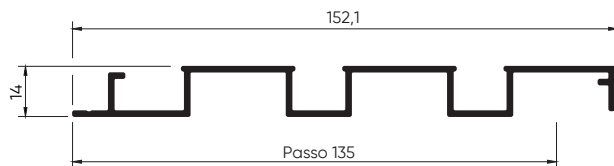
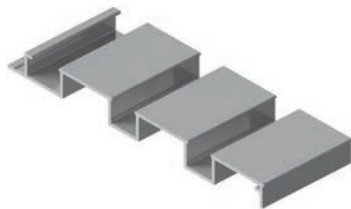

RECEBE LED



DIFUSOR

DIF-004

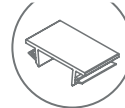

ALV-2512

Lambri Ripado | Passo 120mm

1,087 Kg/m

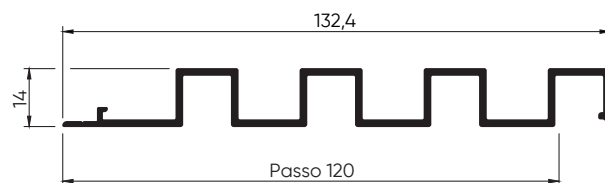

ALV-2518

Perfil Ripado | Passo 135 | Leve

0,800 Kg/m

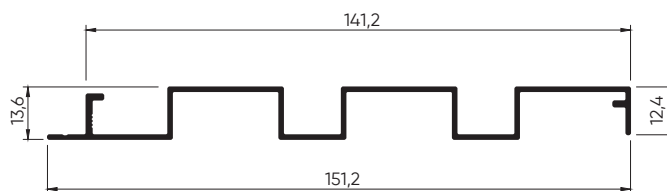
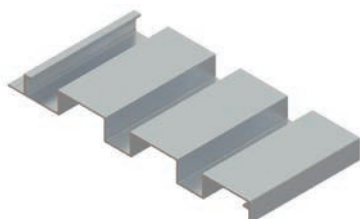

DES-006

Trilho Esquadrias Madeira
0,181 Kg/m

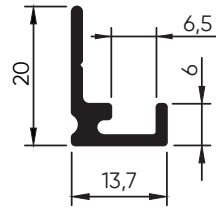

DES-027

Trilho Esquadrias Madeira
0,161 Kg/m

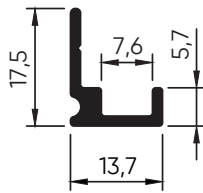

DES-028

Trilho Esquadrias Madeira
0,138 Kg/m

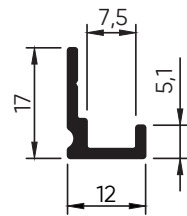

DES-059

Trilho Esquadrias Madeira
0,222 Kg/m

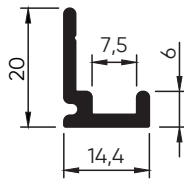

DES-164

Trilho Esquadrias Madeira
0,265 Kg/m

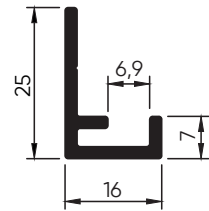
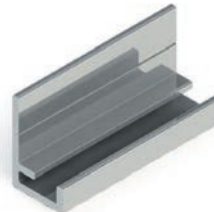

DES-242

Trilho Esquadrias Madeira
0,166 Kg/m

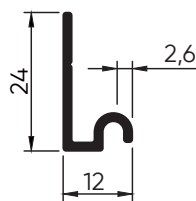

DES-033

Trilho Esquadrias Madeira
0,792 Kg/m

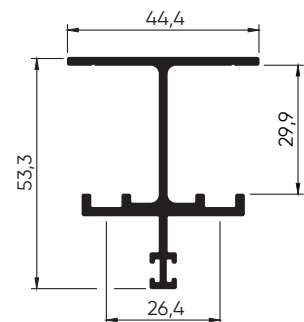
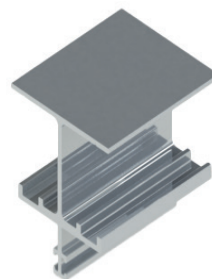

A ALUMICONTE reserva-se o direito de fazer modificações em qualquer informação escrita neste catálogo sem aviso prévio. Os desenhos aqui contidos possuem medidas teóricas de massa e tolerâncias dimensionais de acordo com a ABNT NBR-8116, podendo haver variações dessas informações no produto final.

DES-034

Trilho Esquadrias Madeira

0,542 Kg/m

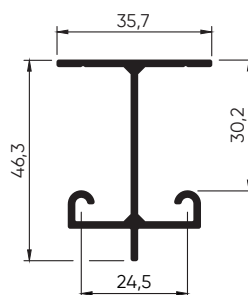

DES-040

Trilho Esquadrias Madeira

0,616 Kg/m

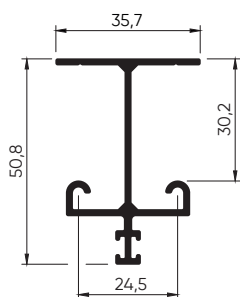

DES-166

Trilho Esquadrias Madeira

1,434 Kg/m

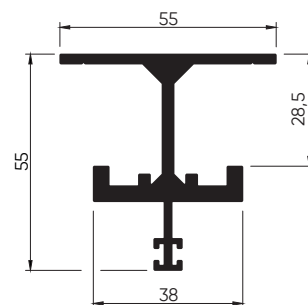
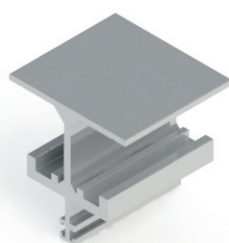

DES-876

Trilho Esquadrias Madeira

0,647 Kg/m

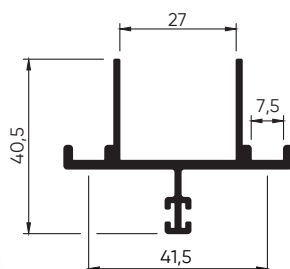
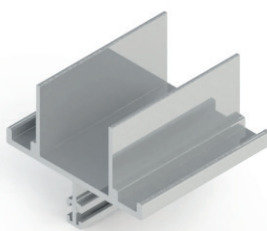

DES-029

Trilho Esquadrias Madeira

0,179 Kg/m

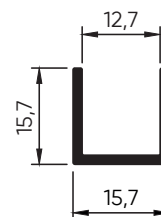
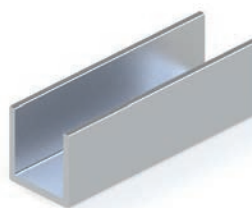

DES-031

Trilho Esquadrias Madeira

0,140 Kg/m

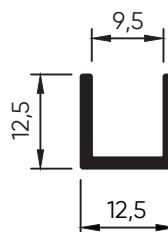
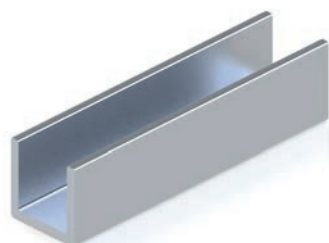

A ALUMICONTE reserva-se o direito de fazer modificações em qualquer informação escrita neste catálogo sem aviso prévio. Os desenhos aqui contidos possuem medidas teóricas e tolerâncias dimensionais de acordo com a ABNT NBR-8116, podendo haver variações dessas informações no produto final.

DIVERSOS

Aqui você encontra uma seleção de perfis versáteis, com diferentes modelos que atendem a uma ampla variedade de aplicações.



Perfil Quadro Espelho
Cód.: DES-2261

DES-2261

Perfil Quadro de Espelho

0,403 Kg/m

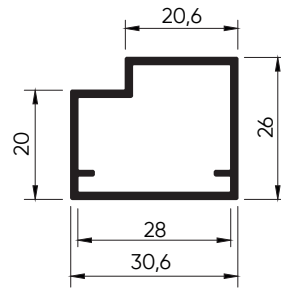

CORTE



MONTAGEM COM ESQUADRETA



RECEBE LED



Montagem Perfil Quadro de Espelho

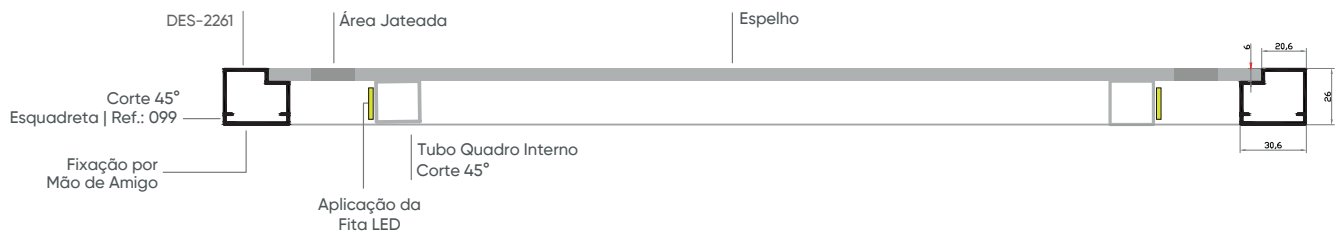

DES-161

Perfil Cabideiro

0,248 Kg/m

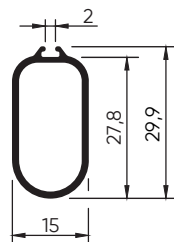

DES-1899

Perfil Cabideiro

0,291 Kg/m

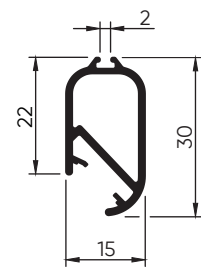

DES-052

Tubo Cabideiro Redondo

0,242 Kg/m

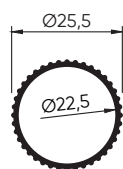

DES-163

Cabideiro Oblongo

0,178 Kg/m



DES-271

Cabideiro Oblongo

0,207 Kg/m

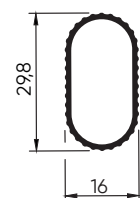

A ALUMICONTE reserva-se o direito de fazer modificações em qualquer informação escrita neste catálogo sem aviso prévio. Os desenhos aqui contidos possuem medidas teóricas de massa e tolerâncias dimensionais de acordo com a ABNT NBR-8116, podendo haver variações dessas informações no produto final.

DES-181

Perfil I Paralelo Nível de Alumínio
0,315 Kg/m

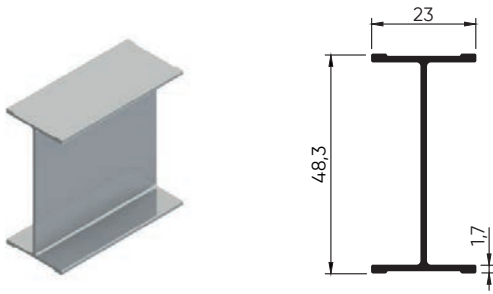

DES-1443

Borda Luminária LED
0,152 Kg/m
Ponteira disponível

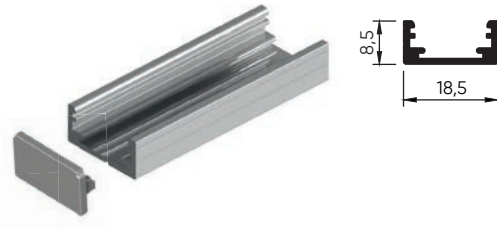

DES-1444

Borda Luminária LED
0,147 Kg/m
Ponteira disponível

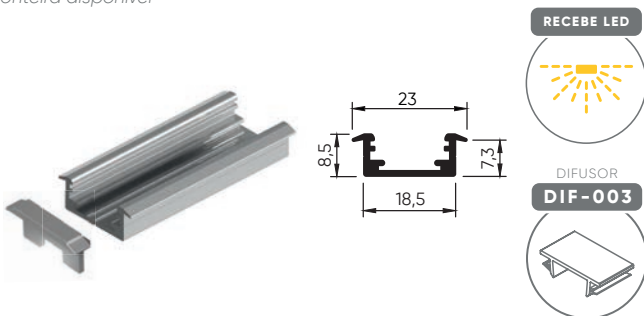

DES-1816

Perfil Borda LED
0,141 Kg/m

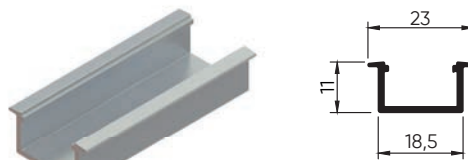

DES-1458

Cantoneira 19x19mm
0,117 Kg/m

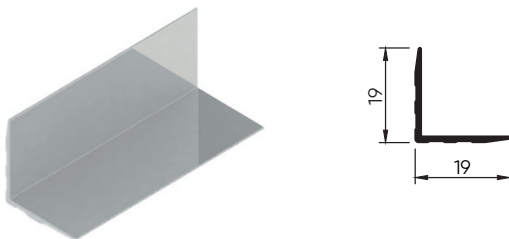

DES-093

Guia de Encaixe Vidro 10mm
0,227 Kg/m

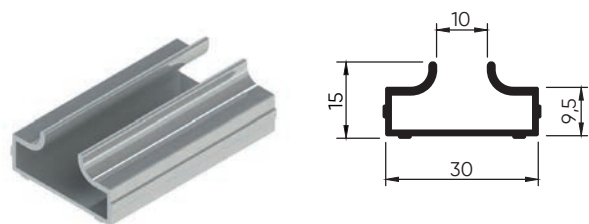

DES-880

Tubo Quadrado 38mm c/ Olhal Fixação
0,928 Kg/m

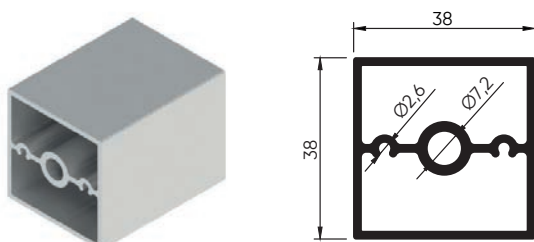

DES-1515

Trilho Mão de Amigo
0,080 Kg/m

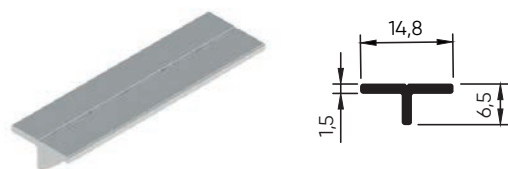

A ALUMICONTE reserva-se o direito de fazer modificações em qualquer informação escrita neste catálogo sem aviso prévio. Os desenhos aqui contidos possuem medidas teóricas de massa e tolerâncias dimensionais de acordo com a ABNT NBR-8116, podendo haver variações dessas informações no produto final.

DES-1253

Complemento Cava Dupla 49x22,5mm
0,559 Kg/m

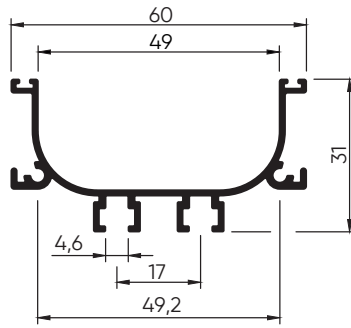

Cantoneira



DES-1254

Complemento Cava Simples 45x22,5mm
0,452 Kg/m

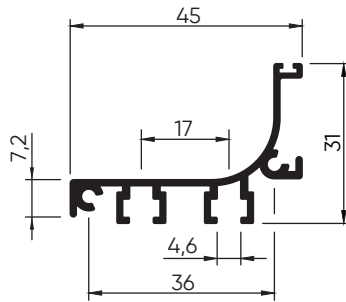
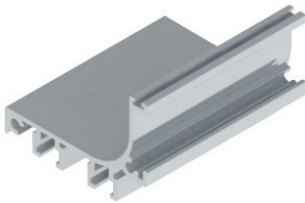

Cantoneira



Aplicação
DES-1253 com cantoneira



Aplicação
DES-1254 com cantoneira

A ALUMICONTE reserva-se o direito de alterar sem aviso prévio. Os desenhos aqui contidos possuem medidas teóricas de massa e tolerâncias dimensionais, podendo haver variações dessas informações no produto final.

Perfil Cava
Cód.: DES-1253
e DES-1254

DES-2259

Rodapé MDF 18 mm

0,358 Kg/m

Ponteira disponível

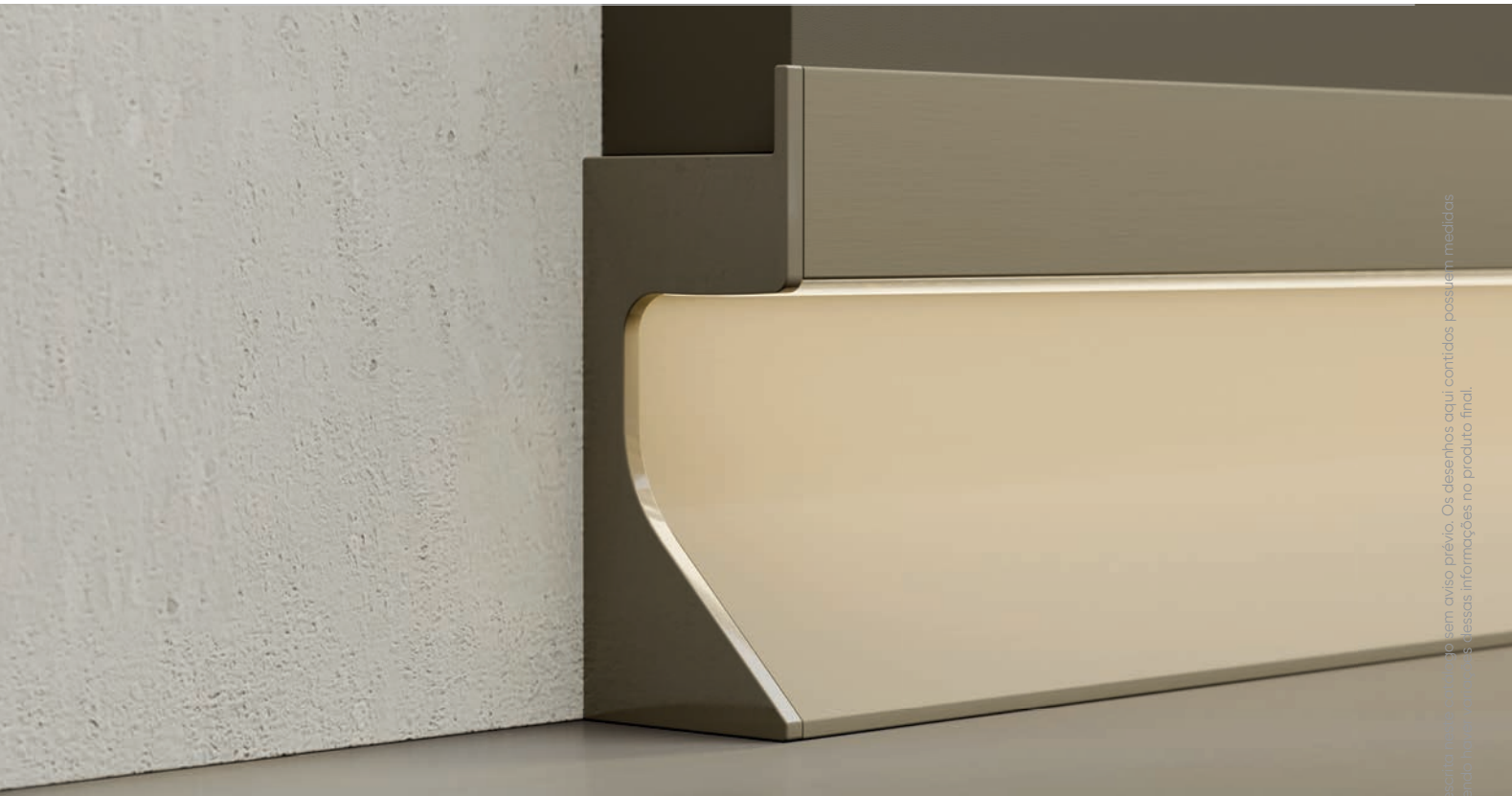
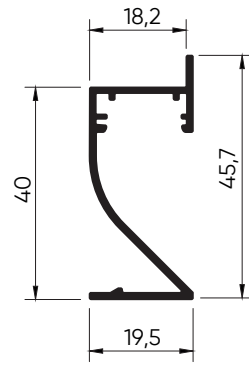
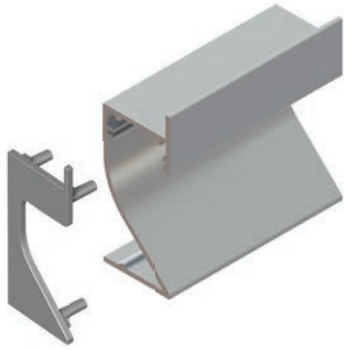

A ALUMICONTE reserva-se o direito de fazer modificações em qualquer informação escrita neste catálogo sem aviso prévio. Os desenhos aqui contidos possuem medidas teóricas de massa e tolerâncias dimensionais de acordo com a ABNT NBR-8116, podendo haver variações. Essas informações são apenas para fins informativos.

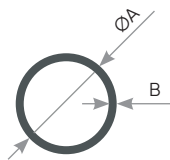

Tubos Redondos

CÓDIGO	DIÂMETRO ØA	ESPESSURA B	PESO
DES-1455	Ø 9,5 mm (3/8")	1,2 mm	0,089 Kg/m
DES-289	Ø 12,7 mm (1/2")	1,6 mm	0,150 Kg/m
BXT-497	Ø 19,05 mm (1/3")	1,3 mm	0,199 Kg/m
BXT-500	Ø 25,4 mm (1")	1,3 mm	0,271 Kg/m
BXT-499	Ø 38,1 mm (1 1/2")	1,3 mm	0,396 Kg/m
DES-097	Ø 50,8 mm (2")	1,2 mm	0,507 Kg/m

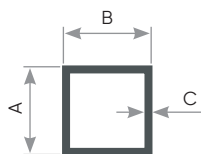

Tubos Quadrados | Retangulares

CÓDIGO	TAMANHO A	TAMANHO B	ESPESSURA C	PESO
DES-1923	9,5 mm (3/8")	9,5 mm (3/8")	1,2 mm	0,110 Kg/m
DES-602	12,7 mm (1/2")	12,7 mm (1/2")	1,5 mm	0,182 Kg/m
DES-998	12,7 mm (1/2")	12,7 mm (1/2")	1,2 mm	0,148 Kg/m
DES-1040	15 mm	15 mm	2 mm	0,282 Kg/m
DES-256	25,4 mm (1")	25,4 mm (1")	1,6 mm	0,398 Kg/m
DES-386	38,1 mm (1 1/2")	38,1 mm (1 1/2")	1,3 mm	0,519 Kg/m
DES-255	38,1 mm (1 1/2")	38,1 mm (1 1/2")	2 mm	0,783 Kg/m
DES-1026	40 mm	40 mm	1,3 mm	0,545 Kg/m
DES-496	13 mm	50 mm	1,3 mm	0,405 Kg/m
DES-1297	40 mm	23,6 mm	1,5 mm	0,500 Kg/m
DES-1016	20 mm	13,6 mm	1,4 mm	0,232 Kg/m

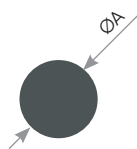

Vergalhões

CÓDIGO	DIÂMETRO ØA	PESO
DES-677	Ø 11,1 mm (7/16")	0,263 Kg/m
DES-678	Ø 12,7 mm (1/2")	0,343 Kg/m

A ALUMICONTE reserva-se o direito de fazer modificações em qualquer informação escrita neste catálogo sem aviso prévio. Os desenhos aqui contidos possuem medidas teóricas de massa e tolerâncias dimensionais de acordo com a ABNT NBR-8116, podendo haver variações dessas informações no produto final.

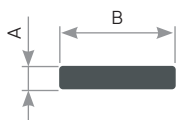

Barras Chatas

CÓDIGO	TAMANHO A	TAMANHO B	PESO
DES-319	3 mm	16 mm	0,126 Kg/m
DES-267	3,18 mm	19,05 mm	0,164 Kg/m
BXT-485	2,5 mm	19 mm	0,130 Kg/m
BXT-483	4 mm	19 mm	0,207 Kg/m
BXT-484	4,5 mm	23 mm	0,284 Kg/m
DES-086	3 mm	25 mm	0,203 Kg/m
DES-087	3 mm	35 mm	0,284 Kg/m
DES-873	4,8 mm	38,1 mm	0,491 Kg/m
DES-742	6,4 mm	43 mm	0,740 Kg/m
DES-140	9,5 mm	44,5 mm	1,145 Kg/m

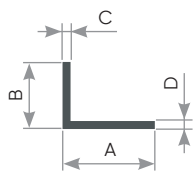

Cantoneiras

CÓDIGO	TAM. A	TAM. B	TAM. C	TAM. D	PESO
ALU-043	46 mm	27,5 mm	2,5 mm	2,5 mm	0,481 Kg/m
ALU-044	46 mm	37,5 mm	4 mm	4 mm	0,893 Kg/m
BXT-498	50,8 mm	50,8 mm	2 mm	2 mm	0,485 Kg/m
DES-151	12 mm	8 mm	1 mm	1,5 mm	0,064 Kg/m
DES-243	15,8 mm	15,8 mm	1,3 mm	1,3 mm	0,106 Kg/m
DES-244	19 mm	19 mm	1,3 mm	1,3 mm	0,129 Kg/m



COMPROMISSO COM A QUALIDADE E O MEIO AMBIENTE, CERTIFICADOS.



Confira nosso site escaneando o QR Code acima.



ALUMICONTE

